



## Report on aircraft accident

Case no: **M-01313/AIG-09**

Date: **21. July 2013**

Location: **Keflavik Airport (BIKF)**

Description: **Runway excursion during flight testing**

Investigation per Icelandic Law on Transportation Accident Investigation, No. 18/2013 shall solely be used to determine the cause(s) and contributing factor(s) for transportation accidents and incidents, but not determine or divide blame or responsibility, to prevent further occurrences of similar cause(s). This report shall not be used as evidence in court.

---

## Contents

Contents.....	2
Synopsis.....	4
1. Factual information .....	5
1.1. History of the flight.....	6
1.2. Injuries to persons .....	13
1.3. Damage to aircraft .....	13
1.4. Other damages .....	13
1.5. Personnel information.....	14
1.6. Aircraft Information .....	17
1.7. Meteorological information.....	18
1.8. Aids to navigation .....	18
1.9. Communications .....	19
1.10. Aerodrome information.....	19
1.11. Flight Recorders.....	20
1.12. Wreckage and Impact information .....	21
1.13. Medical and pathological information.....	24
1.14. Fire .....	24
1.15. Survival aspects.....	24
1.16. Test and research .....	26
1.17. Organizational and management information .....	26
1.18. Additional information.....	26
1.19. Useful or effective investigation technique.....	27
2. Analysis.....	28
2.1. General .....	28
2.2. Flight operation .....	30
2.2.1. The planned execution of flight test #978.....	31
2.2.2. The actual execution of flight test #978 .....	31
2.2.3. Crew qualification.....	34
2.2.4. Operational procedures.....	34
2.2.5. Weather.....	35
2.2.6. Air traffic control .....	35
2.2.7. Communication .....	36
2.2.8. Aids to navigation.....	36
2.2.9. Aerodrome .....	36

2.3.	Aircraft .....	38
2.3.1.	Aircraft maintenance .....	38
2.3.2.	Aircraft performance.....	39
2.3.3.	Mass and balance .....	39
2.3.4.	Aircraft instrumentation .....	39
2.3.5.	Aircraft systems.....	39
2.4.	Human Factors .....	39
2.4.1.	Pressure – One flight crew with limited on duty rotation.....	39
2.4.2.	Fatigue – Extended duty.....	40
2.5.	Survivability.....	45
2.5.1.	Rescue service response .....	47
2.5.2.	Analysis of injuries and fatalities .....	47
2.5.3.	Survival aspects .....	47
3.	Conclusion .....	52
4.	Safety Recommendations.....	55

## Synopsis

At 04:03 AM on July 21<sup>st</sup> 2013, Sukhoi RRJ-95B, of Russian experimental registry 97005, took off from Keflavik Airport (BIKF) for flight certification tests.

The purpose of the flight certification tests was to expand the airplane's capabilities for CAT IIIA automatic approach.

Seven approaches and go-arounds were performed with possible landing gear touchdown to RWY<sup>1</sup> 20, followed by two to RWY 11. The objective of the last approach to RWY 11 was to assess the automatic flight control system performance during go-around at radio altitude of 2-3 feet above the runway, with the right engine shut down and crosswind exceeding 10 m/s (19.5 knots).

During this last go-around the airplane climbed to 27 feet altitude after the landing gear had been selected to the up position, followed by a loss of altitude. The airplane hit the runway with the landing gear retracted and skidded down the runway on the fuselage aft lower belly and the engine cowlings. The airplane skidded off the end of RWY 11 and came to rest 163 meters beyond the threshold of RWY 29.

The crew evacuated the airplane and during the evacuation one crew member suffered minor injuries.

The ITSB has determined the most probable cause of the accident to be flight crew fatigue.

Nine safety recommendations and one safety action are issued.

---

<sup>1</sup> Runway

## 1. Factual information

Factual information	
<b>Place:</b>	Keflavik Airport (BIKF), RWY 11
<b>Date:</b>	July 21 <sup>st</sup> , 2013
<b>Time<sup>2</sup>:</b>	05:23 AM
<b>Aircraft:</b>	<ul style="list-style-type: none"> <li>• <b>type:</b> Sukhoi Civil Aircraft, Superjet 100, RRJ-95B</li> <li>• <b>registration:</b> 97005</li> <li>• <b>year of manufacture:</b> 2010</li> <li>• <b>serial number:</b> 95005</li> <li>• <b>Engines:</b> Two Powerjet SAM-146-1S17</li> <li>• <b>CoA:</b> <ul style="list-style-type: none"> <li>• Valid Experimental Aircraft Airworthiness Certificate issued by the Ministry of Industry and Trade of the Russian Federation</li> <li>• Valid Special Airworthiness Certificate issued by the Interstate Aviation Committee</li> </ul> </li> <li>• <b>Nationality:</b> Russian</li> </ul>
<b>Type of flight:</b>	Test flight
<b>Persons on board:</b>	5 crew members
<b>Injuries:</b>	One crew member suffered minor injury
<b>Nature of damage:</b>	Extensive structural damage to aft lower fuselage, engines and main landing gear doors
<b>Short description:</b>	During flight testing with one engine operational, the inoperative engine throttle was advanced during go-around, after a low pass/missed approach, resulting in the aircraft landing on the runway with the landing gear retracted
<b>Owner:</b>	Sukhoi Civil Aircraft
<b>Operator:</b>	Sukhoi Civil Aircraft
<b>Meteorological conditions:</b>	Instrument Meteorological Conditions (IMC)
<b>Flight rules:</b>	Instrument Flight Rules (IFR)

<sup>2</sup> All times in the report are UTC and where applicable local times are shown in ( ).

## 1.1. History of the flight

At 04:03 AM on July 21<sup>st</sup> 2013, Sukhoi RRJ-95B<sup>3</sup> airplane of Russian experimental registry 97005 took off from Keflavik Airport (BIKF) for flight testing with a crew of five on board. The airplane, which was owned and operated by Sukhoi Civil Aircraft, had been undergoing certification flight tests for almost one month at Keflavik Airport. This was the crew's fourth test flight since their work shift started at 18:00 the day before. The pilot flying was sitting in the right cockpit pilot seat.

During the final approach to RWY 11 at 05:22:22, the landing gear was selected to down position. See Figure 1. The approach was normal.



**Figure 1: Landing gear down on final approach to RWY 11**

At 05:23 the flight crew initiated the 9<sup>th</sup> test of the flight, which was test #978. The purpose of the test was to simulate a CAT IIIA automatic approach, close to the airplane's maximum landing weight limit<sup>4</sup>, while in crosswind exceeding 10 m/s (19.5 knots), with a critical engine failure occurring at radio altitude<sup>5</sup> of 25 feet, resulting in a low pass/missed approach. To prepare for this test, the flight

---

<sup>3</sup> Also known as Superjet 100

<sup>4</sup> MLW 41,000 kg and test performed at  $G_{max}$  38,000–41,000 kg and  $CG_{mid}$  between 12–15%

<sup>5</sup> Distance between aircraft and ground below it

certification expert sitting in the jump seat in the cockpit selected right engine failure on the ATTCS<sup>6</sup> Test Panel located on the pedestal before approach. See Figure 2.

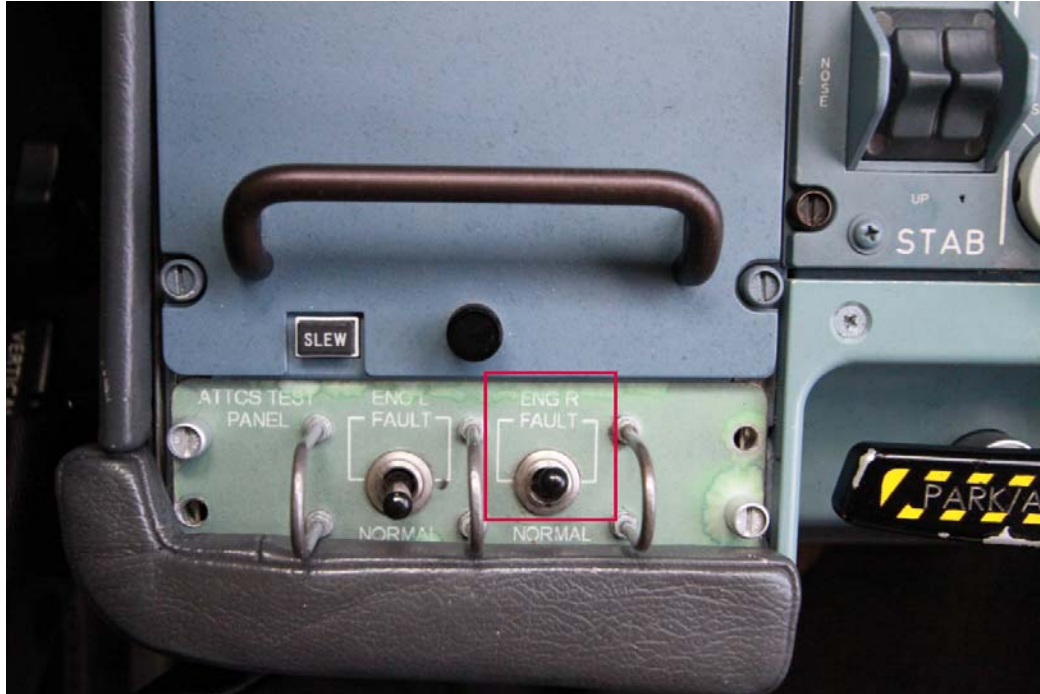

**Figure 2: Right engine fault selected on the ATTCS test panel**

The AP<sup>7</sup>, FD<sup>8</sup> and both the left and the right A/T<sup>9</sup> were ENGAGED during the approach.

At 05:23:25 in accordance with AFCS<sup>10</sup> logic at radio altitude H<sub>RA</sub>=17ft in response to a signal "RETARD", both the left and the right TQL<sup>11</sup> started to move to IDLE<sup>12</sup>.

At 05:23:26 when a/c was at radio altitude of about 10 ft. the flight certification expert sitting in the jump seat in the cockpit shut down the right engine using the ENG MASTER SWITCH.

---

<sup>6</sup> Automatic Take-off Thrust Control System

<sup>7</sup> Autopilot or Automatic Pilot

<sup>8</sup> Flight Director

<sup>9</sup> Auto Throttle

<sup>10</sup> Automatic Flight Control System

<sup>11</sup> Throttle Quadrant Lever, also called Throttle Lever Assembly or TLA

<sup>12</sup> IDLE on the TQL is at 0 deg

At 05:23:26.5, after the right engine was shut off, the right A/T disconnected and the right TQL stopped moving to idle, staying at 13.6°, while the left A/T continued moving the left TQL back to idle.

At 05:23:27 at radio altitude of about 4ft the pilot flying disengaged the AP by pressing “SS/PRIOR/AP OFF” button on the side stick. This caused disengagement of all AP/FD control modes and the left A/T reverted to SPEED mode. When the left A/T reverted to SPEED mode, the left TQL had already reached IDLE. At that time the airplane speed had reduced down below the “limit selectable speed”, so the left A/T started moving the left TQL forward.

The pilot flying pressed the TOGA<sup>13</sup> button on the right TQL to initiate a go-around and, according to the cockpit voice recorder, called out “go-around”.

Almost simultaneously, at 05:23:28.70, the main landing gear touched the RW and as a result of left main LG shock strut compression a/c avionics complex received WOW signal (weight on wheels). See Figure 3.



**Figure 3: Touchdown with the landing gear down**

---

<sup>13</sup> Take-Off / Go-Around



In response to WOW signal and in accordance with AFCS logic and SC-AWO<sup>14</sup> 316 requirements left engine AT and FD disengaged automatically. At the moment of left engine AT disengagement left engine TQL was at 16.59°.

The pilot flying then noticed at the primary flight display that the go-around mode had not engaged when he selected the TOGA switch. Details on this system can be found in Figure 4. The pilot flying also noticed that the FD was not available and that the A/T was switched off.

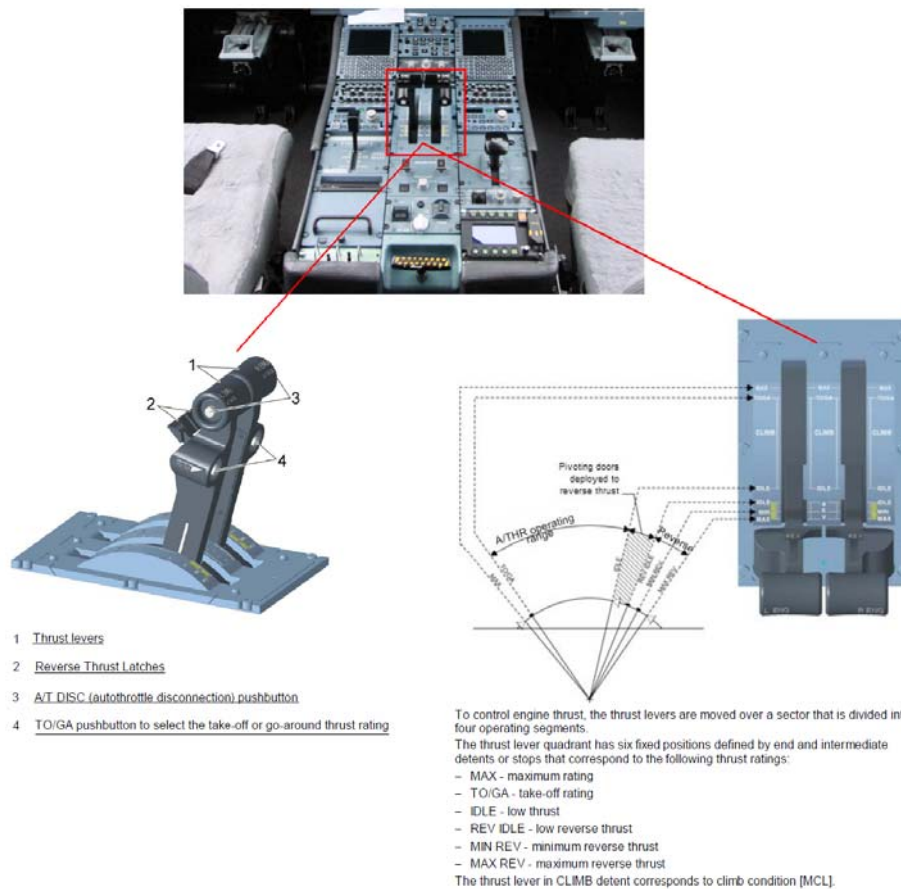

**Figure 4: Explanation of the TQL and the TOGA**

PF started to perform go around in manual mode, set right (inoperative) engine TQL to TO/GA, pitched-up the a/c and ordered LG retraction. LG switch was set to UP position at 05:23:36. Meanwhile left (operative) engine TQL was left in 16.59° position.

<sup>14</sup> Certification Specification for All Weather Operation

During the go-around procedure, after the landing gear was retracted, the airplane started to loose speed to  $V_{LS}$ <sup>15</sup> and below. As the speed reached the red sector<sup>16</sup>, the airplane stopped climbing having reached a maximum radio altitude of 27 feet at 05:23:37 and then started to descend. The speed<sup>17</sup> decreased further, below 120 knots. The pilot flying then set the right TQL to MAX. The speed continued to decrease and the pilot flying, now aware of both the speed loss and the loss of altitude, reduced the nose pitch to try to counteract stalling. The airplane's aural warning "LANDING GEAR NOT DOWN" triggered at that time.

The pilot flying realized that engine was not in takeoff mode and checked engine power settings on the EWD<sup>18</sup>. He found out that operating left engine was in N1=50% mode and realized that he had been controlling the inoperative engine. The pilot flying set the left engine TQL to MAX at 05:23:45. The airplane was still descending and at 05:23:47 and while the left engine was spooling up, the airplane hit the runway.

As the landing gear was in the up position, it was the fuselage aft lower belly that hit the runway at 05:23:47. This was on the left side of the runway center line, as due to the loss of airspeed and the crosswind the airplane had drifted to the left. This was followed by the engines' cowlings touching the runway at 05:23:49.

As the airplane nose had been turned into the wind when it hit the runway, it initially veered to the right, as it skidded down the runway, across the runway centerline. The pilot flying counteracted this movement with a left rudder input and steered the airplane back towards the runway centerline.

The pilot flying set both TQL's to IDLE position at 05:23:52 and then to REV MAX<sup>19</sup> in order to increase air drag. The left engine was shut down at 05:24:00.

The airplane skidded off the end of RWY 11 and came to rest at 05:24:25 after having passed 163 meters beyond the threshold of RWY 29. See Figure 5.

---

<sup>15</sup> Lowest selectable speed

<sup>16</sup>  $V_{STALL\ WARNING}$

<sup>17</sup>  $V_{CAS}$

<sup>18</sup> Engine Warning Display

<sup>19</sup> Maximum Reversed Thrust



**Figure 5: The airplane came to rest beyond the threshold of RWY 29**

After the airplane had come to a stop, the pilot in command, who was also the pilot flying, ordered an emergency evacuation. The forward left door was opened by the cockpit crew, but the emergency escape slide did not deploy. See Figure 6. The crew member operating the test equipment in the cabin opened the rear left door and its slide deployed. The cockpit crew then opened the forward right door. The slide deployed, but due to the crosswind it blew underneath the belly of the airplane and was unusable. The whole crew evacuated the airplane via the rear left door. See Figure 7.



**Figure 6: Forward RH emergency escape slide unusable**



**Figure 7: Crew evacuated the airplane via the rear left door**

## 1.2. Injuries to persons

One crew member working at a test equipment operator's station suffered minor injuries during evacuation and was assisted by two other crew members to a safe distance from the airplane. The crew member was examined and partly treated for his injuries at a nearby hospital<sup>20</sup>.

## 1.3. Damage to aircraft

The airplane's aft lower fuselage section was extensively damaged. Other damage, included both engines and cowlings. See Figure 8.

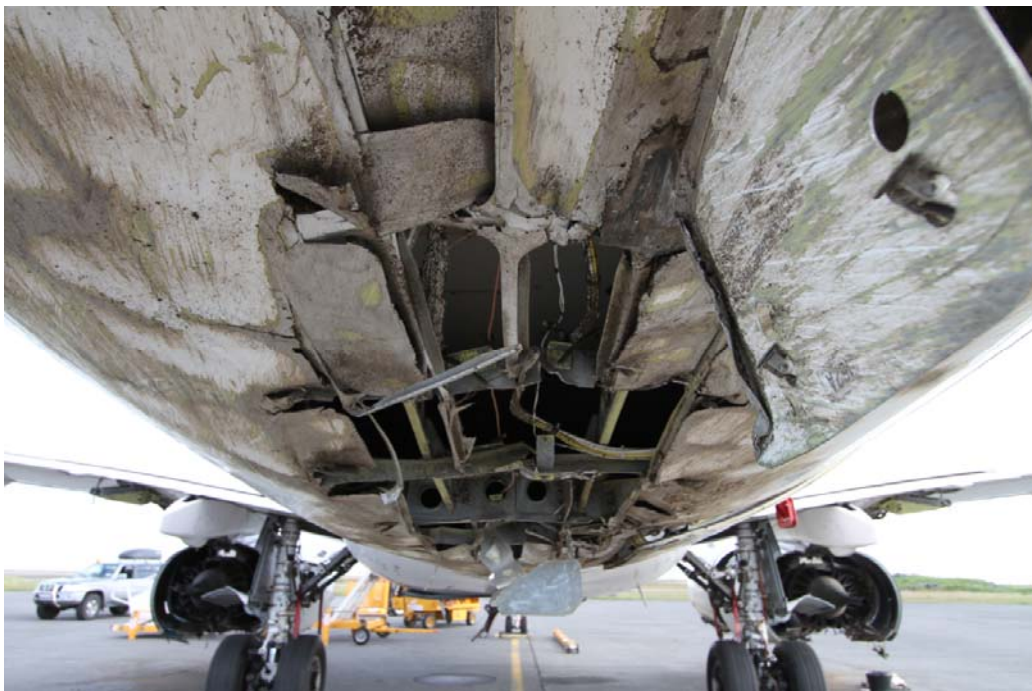

Figure 8: Damage to the aircraft

## 1.4. Other damages

When the airplane skidded off the runway it damaged five rows of runway approach lights, for a total of 25 runway approach lights. One runway light, where RWY 11 and RWY 20 cross, was damaged and minor damage to RWY 11 asphalt was also observed.

---

<sup>20</sup> Heilbrigðisstofnun Suðurnesja, HSS

1.5. Personnel information

Commander - Pilot flying (right seat) – Pilot in command									
<b>Age:</b>	45 years old								
<b>License:</b>	Instructor & test pilot								
<b>Medical certificate:</b>	Valid								
<b>Ratings:</b>	<ul style="list-style-type: none"> <li>• Mi-2/8/17/24</li> <li>• L-29/39/410</li> <li>• MiG- 21/23/25/29</li> <li>• Sukhoi – 17/25/30</li> <li>• Antonov -2/12/24</li> <li>• Be- 103</li> <li>• Gzhel</li> <li>• Ilyushin -76/78/103/1L</li> <li>• Icarus</li> <li>• MAI</li> <li>• Sigma-4/5</li> <li>• Tupolev-154</li> <li>• Yakovlev -18/52</li> <li>• Y—450</li> <li>• E-480</li> <li>• Piper</li> <li>• Extrim</li> <li>• RRJ-95</li> </ul>								
<b>Experience:</b>	<table border="1" style="width: 100%; border-collapse: collapse;"> <tbody> <tr> <td style="width: 60%;">Total all types:</td> <td>2789:17 hours</td> </tr> <tr> <td>Total on type:</td> <td>963:27 hours</td> </tr> <tr> <td>Last 90 days:</td> <td>87:49 hours</td> </tr> <tr> <td>Last 24 hours:</td> <td>7:58<sup>21</sup> hours</td> </tr> </tbody> </table>	Total all types:	2789:17 hours	Total on type:	963:27 hours	Last 90 days:	87:49 hours	Last 24 hours:	7:58 <sup>21</sup> hours
Total all types:	2789:17 hours								
Total on type:	963:27 hours								
Last 90 days:	87:49 hours								
Last 24 hours:	7:58 <sup>21</sup> hours								
<b>Previous rest period:</b>	Well rested before originally planned flight duty								

<sup>21</sup> Test flights #975, #976, #977 and #978: 130 min + 130 min + 130 min + 88 min

**Commander - Pilot monitoring (left seat)****Age:** 58 years old**License:** Test pilot**Medical certificate:** Valid

- Ratings:**
- L-29/39
  - Sukhoi – 24
  - Antonov -2/24/26/30/72/74/124-100m/140-100
  - Ilyushin - 28/62/76/82/86/96-300/96-400/114/114-100
  - M-16
  - Tupolev – 16/22/134/154/160/204/214
  - Yakovlev – 28/40/42
  - Mi-2
  - Falcon-2000
  - CL – 600-2B19/604
  - DHC -8-200/8-300
  - GV-X
  - Challenger
  - Hawker
  - ATR-72-212A
  - CR-200
  - RRJ-95

<b>Experience:</b>	Total all types:	12288:25 hours
	Total on type:	102:49 hours
	Last 90 days:	80:47 hours
	Last 24 hours:	7:58 hours

**Previous rest period:** Well rested before originally planned flight duty

Flight certification expert (jump seat)									
<b>Age:</b>	63 years old								
<b>License:</b>	Test pilot								
<b>Medical certificate:</b>	Valid								
<b>Ratings:</b>	<ul style="list-style-type: none"> <li>• Antonov -12/24/26/28/30/32/38/71/72/74</li> <li>• Ilyushin – 14/18/62/76/78/82/86/103/976</li> <li>• Tupolev – 16/95/124/134/154/204/214</li> <li>• A-310/320/340-300</li> <li>• Yakovlev-28</li> <li>• Mi-8</li> <li>• MiG- 21/23/25/27.31</li> <li>• Sukhoi –7/ 9/ 15/17/24/25/30</li> <li>• L-29</li> <li>• Y-7-200B/7-500H</li> <li>• F-18B</li> <li>• T-34c</li> <li>• Sabre</li> <li>• ATTAS</li> <li>• RRJ-95</li> </ul>								
<b>Experience:</b>	<table border="1"> <tbody> <tr> <td>Total all types:</td> <td>10465:47 hours</td> </tr> <tr> <td>Total on type:</td> <td>419:48 hours</td> </tr> <tr> <td>Last 90 days:</td> <td>42:35 hours</td> </tr> <tr> <td>Last 24 hours:</td> <td>7:58 hours</td> </tr> </tbody> </table>	Total all types:	10465:47 hours	Total on type:	419:48 hours	Last 90 days:	42:35 hours	Last 24 hours:	7:58 hours
Total all types:	10465:47 hours								
Total on type:	419:48 hours								
Last 90 days:	42:35 hours								
Last 24 hours:	7:58 hours								
<b>Previous rest period:</b>	Well rested before originally planned flight duty								



## 1.6. Aircraft Information

The airplane, Sukhoi Civil Aircraft, Superjet 100, RRJ-95B of Russian experimental registry 97005, was owned and operated by Sukhoi Civil Aircraft. It was undergoing certification flight tests to extend its flight envelope from CATII certificate to CAT IIIA certificate. The approach objective in flight test #978 was to assess the AFCS performance in FD mode during go-around at radio altitude of 2-3 feet, with critical<sup>22</sup> right engine shut down and crosswind exceeding 10 m/s (19.5 knots). As part of that extended CAT IIIA certification, flight tests had to be performed to show compliance with EASA<sup>23</sup> CS-AWO 140, Approach and Automatic Landing with an Inoperative Engine.

The airplane, RRJ-95B of registry 97005, was manufactured by Sukhoi Civil Aircraft in February 2010. It received an Experimental Aircraft Airworthiness Certificate<sup>24</sup> as well as Test-Aircraft Certificate of Registration<sup>25</sup>, issued by the Russian Ministry of Industry and Trade on August 12<sup>th</sup> 2010. It also received Type Certificate<sup>26</sup> issued by the Interstate Aviation Committee on January 28<sup>th</sup> 2011 and Special Airworthiness Certificate<sup>27</sup> issued by the Interstate Aviation Committee on August 15<sup>th</sup> 2012. The Interstate Aviation Committee type certificate of Sukhoi Civil Aircraft airplane type RRJ-95B was then validated by EASA under type certificate EASA.IM.A.176, issued on February 3<sup>rd</sup> 2012.

The last scheduled maintenance check on the airplane, before the accident was a C-check that was performed on the airplane in May 2013. There were no open technical items on the airplane at the time of the accident.

At the time of the accident, the airplane had accumulated 1150.75 FH<sup>28</sup>, 978 flights and 1608 pressure cycles. Engine #1 had accumulated 1123.04 FH and engine #2 had accumulated 1391.99 FH. The airplane had 349.25 FH remaining until next scheduled maintenance.

---

<sup>22</sup> The RRJ-95B does not have a critical engine, but EASA CS-AWO 140 requires the test to be performed for the aircraft's critical engine. Therefore the test was performed for both the LH engine swithed off (flight test #977) and for the RH engine swithed off (flight test #978)

<sup>23</sup> European Aviation Safety Agency

<sup>24</sup> Certificate number 95/13-411

<sup>25</sup> Certificate number 409

<sup>26</sup> Certificate number 322-RRJ-95

<sup>27</sup> Certificate number 123-RRJ-95B

<sup>28</sup> Flight Hours

Fuel calculations indicated that the airplane had 1056.5 kg of remaining fuel from the previous flight on board. Prior to the 4<sup>th</sup> test flight 3205 USG of Jet A-1 fuel were added to the airplane at Keflavik Airport from a fuel truck. The same fuel truck had been used to re-fuel the airplane for the previous flights. According to Sukhoi Post Flight Report<sup>29</sup>, the total fuel load on board the airplane prior to the accident flight was calculated to be 10,956.5 kg of Jet A-1 fuel. After the accident the fuel truck that provided the fuel was impounded and fuel samples taken from it as well as from the airplane.

The airplane takeoff weight was 41,240 kg. The airplane's MTOW<sup>30</sup> is 45,880 kg. At the time of the accident, FDR data indicated the gross weight of the airplane to be 37,968.3 kg. The airplane has a MLW<sup>31</sup> of 41000 kg.

### **1.7. Meteorological information**

According to the pilot flying, during the approach to RWY 11 the wind was 190°/20 knots. The visibility was 8000m, broken clouds at 400ft, overcast at 600ft, OAT 11°, dew point 11° and the QNH 1015 hPa.

According to the Icelandic Meteorology Office, the Keflavik Airport METAR reports effective around the time of the incident were:

METAR BIKF 210500Z 16018G24KT 9999 SCT004 OVC008 10/10 Q1015

METAR BIKF 210530Z 16021KT 9999 -DZ BKN005 OVC007 10/10 Q1015

Note:

The magnetic variation at BIKF airport at the time of the accident was 16° W

### **1.8. Aids to navigation**

The flight crew was performing an instrumental landing approach, utilizing the ILS for RWY 11, during the low pass / missed approach flight test.

---

<sup>29</sup> Sukhoi test flight report

<sup>30</sup> Maximum Take Off Weight

<sup>31</sup> Maximum Landing Weight

## **1.9. Communications**

The flight crew was in contact with ATC Approach for Keflavik Airport on radio frequency 119.300 MHz and the ATCO<sup>32</sup> for Keflavik Tower on radio frequency 118.300 MHz, during the approach before the low pass / missed approach flight test when the accident occurred.

The Sukhoi flight crew requested, and was granted by the tower ATCO at 05:21:13, touch and go approval for RWY 11.

The cockpit voice recorder provided communications that took place between the flight crew with regards to the flight test and the accident.

## **1.10. Aerodrome information**

At the time of the accident the active runway was RWY 20. The Sukhoi airplane was performing certification test for crosswind and therefore the use of RWY 11 was requested.

The applicable rules and regulations for Keflavik Airport (BIKF) can be found in the Icelandic AIP<sup>33</sup> Aerodromes section, BIKF AD. The investigation revealed that some of the requirements of the AIP regarding the use of RWY 11 were not adhered to.

When the Sukhoi 97005 airplane skidded down RWY 11, a B757 airplane that had landed previously on RWY 20 was holding short of RWY 11 on TWY E-2 (Echo), near the end where TWY E-3 begins. See Figure 9 for details.

---

<sup>32</sup> Air Traffic Control Officer

<sup>33</sup> Aeronautical Information Publication

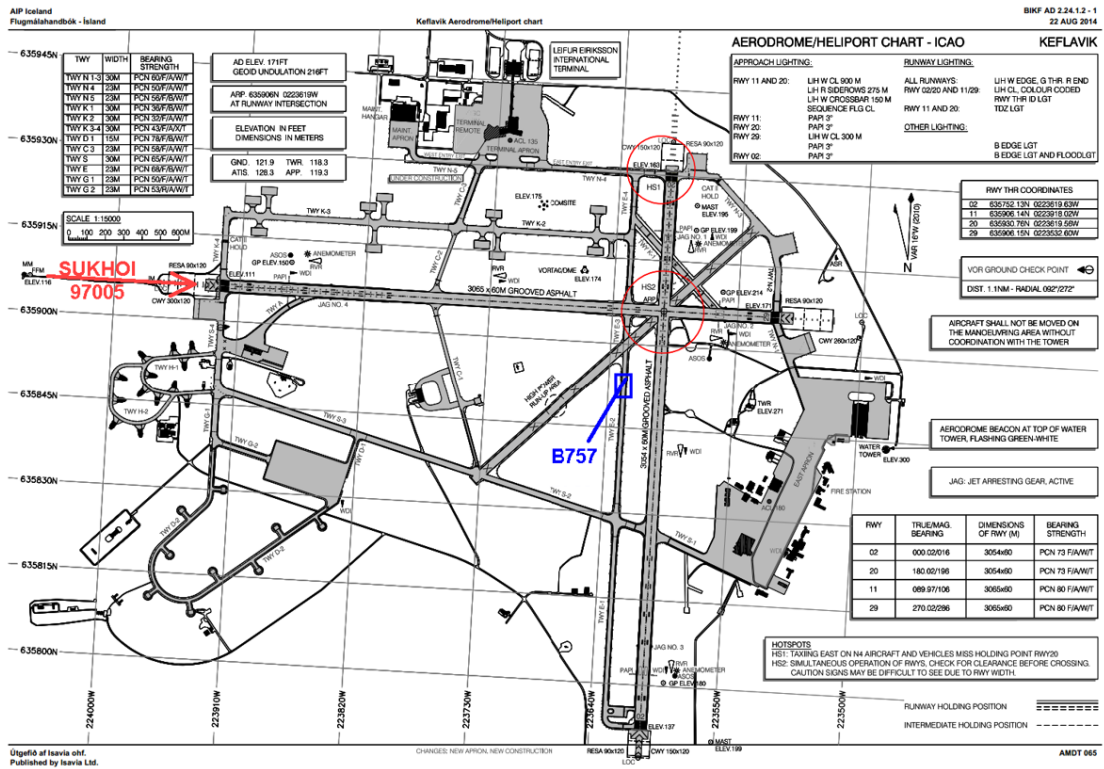

Figure 9: Chart showing Keflavik Airport (Isavia)

### 1.11. Flight Recorders

The Icelandic Transportation Safety Board<sup>34</sup> removed the flight data recorder (FDR) and the cockpit voice recorder (CVR) from the airplane. The FDR and the CVR were transported to the Interstate Aviation Committee<sup>35</sup> in Moscow, where their contents were downloaded and analyzed under the supervision of the ITSB. The FDR recorded parameters every 0.1 seconds instead of the usual 1 per second. This was important to understand what occurred during the critical seconds prior to the accident.

The ITSB also utilized multiple other sources of information being monitored and recorded on board the airplane, as this was a test flight, including data from the test equipment as well as video surveillance recording from the flight deck.

<sup>34</sup> ITSB, or „Rannsóknarnefnd samgönguslysa“ (RNSA) in Icelandic

<sup>35</sup> The Interstate Aviation Committee is formed on the basis of intergovernmental agreement on civil aviation and air space use signed on 30.12.1991. Its member states are Azerbaijan, Armenia, Belarus, Kazakhstan, Kyrgyzstan, Moldova, Russian Federation, Tadjikistan, Turkmenistan, Uzbekistan and Ukraine

### 1.12. Wreckage and Impact information

The airplane landed on RWY 11 on its lower aft fuselage belly left of the center line, about 360 meters beyond TWY C1/C2. The airplane then skidded 1.6 km down the runway and came to rest after having passed 163 meters beyond the threshold of RWY 29.

Detailed measuring and recording of the skid marks was performed by local police investigators<sup>36</sup> with the assistance of the Icelandic Coast Guard. Part of Figure 10 and Figure 11 to Figure 13 are from the police report.



Figure 10: Keflavik Airport (BIKF) and RWY 11 (view in red enlarged twice)

<sup>36</sup> Lögreglan á Suðurnesjum, Rannsóknardeild

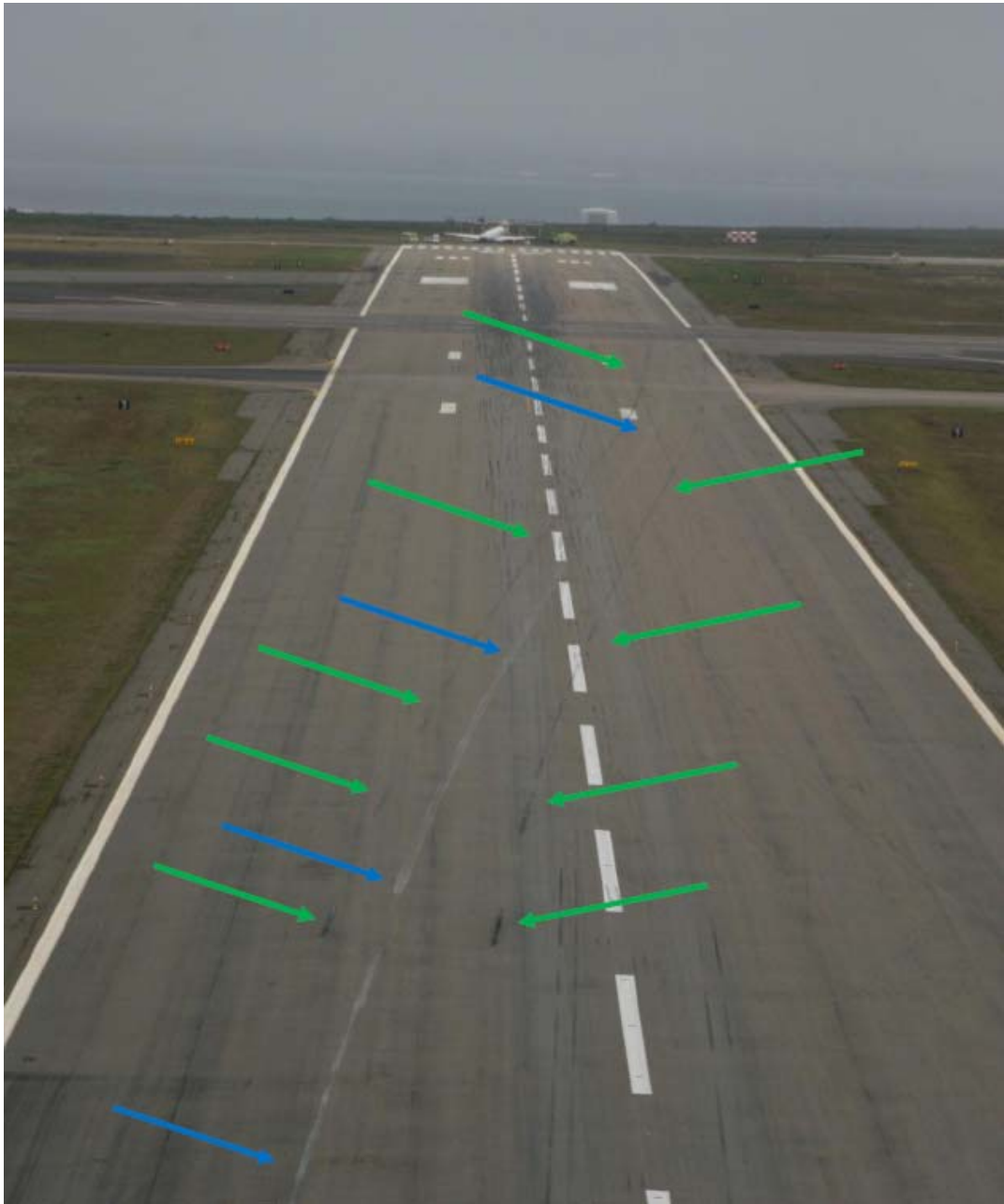

**Figure 11: Airplane skid marks on RWY 11 (blue = fuselage / green = engines)**



**Figure 12: Airplane at RWY 11 right edge when crossing RWY 20**

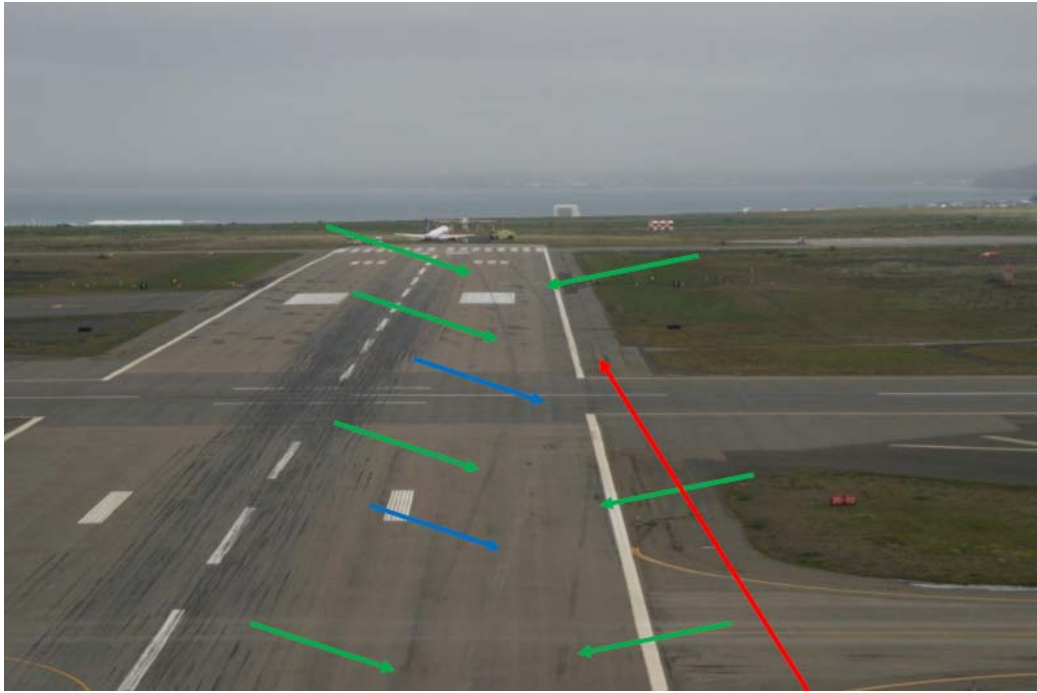

**Figure 13: Airplane skid marks on RWY 11**  
(blue = fuselage / green = engines / red = broken RWY light)



**Figure 14: Airplane skidded off the end of RWY 11**

### **1.13. Medical and pathological information**

During the ITSB interviewing of the crew, it became evident that the crew was both mentally and physically fatigued.

Blood and urine samples were taken from all crew members, about 1.5 hour after the accident. Analysis of the samples confirmed that no crew member was under the influence of alcohol.

### **1.14. Fire**

When the airplane skidded down the runway metal sparks emanated. No fire ignited.

### **1.15. Survival aspects**

During the accident, three crew members were in the cockpit and two crew members at test equipment operator's stations in the cabin.

The airplane's ELT did not activate.

The ATCO on duty in the tower at Keflavik Airport activated the airport's fire department at 05:24:10. The airport's emergency plan<sup>37</sup> was not activated until 05:32:36.

The emergency escape slide of the forward left door did not deploy when the door was opened by a cockpit crew member. Inspection of the arming handle revealed that the door emergency escape slide had not been set to the armed position. See Figure 15 for details.

Before the forward right door was opened, the slide was armed. When the door was opened the slide deployed, but due to the crosswind it blew underneath the fuselage of the airplane, rendering it unusable. See Figure 16 for details.

One of the crew members from the cabin test equipment operator stations armed the rear left door slide, opened the door and the slide deployed. All the crew

---

<sup>37</sup> Flugslýsaáætlun fyrir Keflavíkurflugvöll, útgafið af Almannavörnum



members evacuated the airplane via the rear left door. During the evacuation one of the crew members suffered minor injuries.



**Figure 15: Forward left cabin door slide was not armed**



**Figure 16: Forward right cabin door slide unusable**

### **1.16. Test and research**

N/A.

### **1.17. Organizational and management information**

Sukhoi Civil Aircraft is the manufacturer of the RRJ-95B, commonly known as the Superjet 100. The airplane involved in the accident was owned and operated by Sukhoi Civil Aircraft and had been undergoing certification flight tests since June 25<sup>th</sup> at Keflavik Airport. The RRJ-95B had already received its type certificate ratings from EASA, but the purpose of the certification flight testing in Iceland was to extend its flight envelope for CATII certificate to CAT IIIA certificate.

The flight test program performed in Iceland on the airplane was set up with two Sukhoi Civil Aircraft test pilots and three flight certification experts, also test pilots, from the Russian Flight Research Institute<sup>38</sup>. These pilots rotated through the flight test program with three on duty during most<sup>39</sup> of the program. The last pilot rotation had been on July 18<sup>th</sup>, when the Sukhoi Civil Aircraft test pilot in the left pilot seat of the accident flight (pilot monitoring) had arrived to replace a test pilot from the Russian Flight Research Institute. An exception to the pilot rotation program was the commander and pilot flying of the accident flight who was on duty through the whole flight test program in Iceland.

On the accident flight, the pilot flying (right pilot seat) and the pilot monitoring (left pilot seat) were both Sukhoi Civil Aircraft test pilots. The test pilot in the jump seat was from the Russian Flight Research Institute and was the flight's certification expert.

### **1.18. Additional information**

On June 13<sup>th</sup> 2013 the Embassy of the Russian Federation in Iceland sent a formal letter to the Icelandic Ministry of Foreign Affairs, informing that the aircraft building company Sukhoi Civil Aircraft of the Ministry of Industry and Trade of the Russian Federation planned to send its aircraft, RRJ-95B of registration

---

<sup>38</sup> M.M Gromov Flight Research Institute, of Russia

<sup>39</sup> The exception being that during five flights in the period of July 2<sup>nd</sup> to July 5<sup>th</sup>, only two pilots were on duty for the flight test program in Iceland

97005, to Iceland to carry out flight certification tests at Keflavik Airport from June 25<sup>th</sup> to July 25<sup>th</sup>, 2013. The Embassy of the Russian Federation requested permission from the Icelandic Ministry of Foreign Affairs for the aircraft to fly over Icelandic airspace from June 25<sup>th</sup> to July 25<sup>th</sup>, 2013, with possible last minute changes in flight schedule due to meteorological or technical reasons to extend the validity of the permission.

The Icelandic Ministry of Foreign Affairs approved the request from the Embassy of the Russian Federation and in a formal letter, sent on June 14<sup>th</sup> 2013, informed the Embassy of the Russian Federation that diplomatic clearance for overflight and landing had been granted as requested from 25<sup>th</sup> June to 25<sup>th</sup> July 2013, with possible last minute changes due to meteorological or technical reasons, for special flights for the aircraft to carry out flight certification tests. The Icelandic Ministry of Foreign Affairs then informed the relevant Icelandic government agencies of this approval, including the Icelandic Transportation Authority.

#### **1.19. Useful or effective investigation technique**

Video recording from the cockpit provided the investigators with visual evidence showing the inoperative engine throttle lever being advanced during the go-around procedure, as well as showing the work load and the task division between the individual flight crew members.

As this was a flight test airplane, it provided numerous sources of flight data monitoring, to vastly greater extent than normally available.

Airport surveillance cameras at RWY 11 at Keflavik Airport provided useful information about the landing to quickly confirm that the landing gear had been down when it initially touched the runway and that the landing gear was then retracted during initial climb.

## 2. Analysis

### 2.1. General

When a foreign operator or foreign authority requests approval for overflight in Icelandic airspace and/or landing in Iceland, it requires definition of type of the aircraft by the Icelandic Transportation Authority<sup>40</sup>. In case the aircraft is designated as a State Aircraft or the aircraft is from a State which is not a member of ICAO<sup>41</sup>, the request is to be handled by the Icelandic Ministry of Foreign Affairs on diplomatic basis. In case the aircraft is a civil aircraft belonging to an ICAO member State, then the application is to be handled by the Icelandic Transportation Authority.

The investigation revealed that the Icelandic Ministry of Foreign Affairs defined the airplane as being a State Aircraft<sup>42</sup>, based on diplomatic communications from the Embassy of the Russian Federation in Iceland which stated "*Sukhoi Civil Aircraft of the Ministry of Industry and Trade of the Russian Federation*", and approved the overflight in Icelandic airspace and landing in Iceland on that basis.

„A clear definition of State Aircraft does not exist in international law. Nonetheless, there is a tendency to define State Aircraft as aircraft controlled by the State and used for public services. The most common definition found in international instruments is 'aircraft used in military, customs and police services'. However, this could not be considered as a general definition of State aircraft, since undoubtedly other State Aircraft exists“<sup>43</sup>.

The Republic of Iceland and the Russian Federation are both members of the Convention on International Civil Aviation<sup>44</sup>, ICAO. According to part b) of Article 3, aircraft used by military, customs and police services shall be deemed to be State Aircraft. The procedure the Icelandic Transportation Authority uses<sup>40</sup> to

---

<sup>40</sup> Flugmálastjórn Ísland, Vinnuferli SS-1.011 Yfirflugs- og lendingarheimildir erlendra flugvéla (Flugmálastjórn Íslands, Icelandic CAA, merged with other Icelandic transportation authorities to form the Icelandic Transportation Authority on July 1st, 2013)

<sup>41</sup> International Civil Aviation Organization

<sup>42</sup> Per part 2.10 in the annex to Icelandic regulation 1025/2012, Icelandic law 60/1998 and part c) in the third article of Convention on International Civil Aviation

<sup>43</sup> Jan Wouters og Sten Verhoeven, "State Aircraft" í Max Planck Encyclopedia of Public International Law

<sup>44</sup> ICAO Sáttmálinn

define state aircraft in addition to the above also mentions aircraft that transport Head of State.

Since the accident, the Icelandic parliament, Alþingi, has passed law 81/2015 which changes article 134 of aviation law 60/1998. In the explanation notes<sup>45</sup> to article 1 of law 81/2015 the term State Aircraft is defined as Civil or Military State Aircraft, including those meant for duty or policing. Civil State Aircraft is any aircraft owned or used by foreign government, which is not being used for commercial purposes and is not a Military State Aircraft. Military State Aircraft is defined as any aircraft under military command of a foreign State or international organization.

The investigation determined that the aircraft was not transporting Head of State, nor was it shown that the aircraft was operated or owned by military, customs or police services.

The investigation showed the accident airplane to be operated and owned by the Russian company Sukhoi Civil Aircraft, which is also its manufacturer. Sukhoi Civil Aircraft is a Russian joint stock company. The ownership of Sukhoi Civil Aircraft at the time of the accident was 71.9929% by the Sukhoi Company, 25.0000% by the Italian company Alenia Aermacchi<sup>46</sup> and 3.0071% owned by Sukhoi Design Bureau.

The investigation showed the Sukhoi Civil Aircraft RRJ-95B airplane registered 97005 to have an Experimental Aircraft Airworthiness Certificate issued by the Ministry of Industry and Trade of the Russian Federation and a Special Airworthiness Certificate issued by the Interstate Aviation Committee.<sup>47</sup>

Airplane 97005 was manufactured in the year 2010. The Sukhoi Civil Aircraft RRJ-95B then received its EASA type certificate EASA.IM.A.176 in the year 2012. The purpose of the visit of the aircraft to Iceland was to undergo certification flight tests to extend its flight envelope from CATII certificate to CAT IIIA certificate, which falls into the category of commercial purposes.

---

<sup>45</sup> greinargerð

<sup>46</sup> Through its subsidiary World's Wing SA

<sup>47</sup> For comparison it is noted that the Icelandic Transportation Authority approves in Iceland similar experimental airworthiness certificates to aircraft that do not meet EASA requirements

According to the procedure the Icelandic Transportation Authority uses<sup>40</sup> to handle applications for overflight in Icelandic airspace and/or landing in Iceland, it involves checking if the airplane has a limited airworthiness certificate, such as experimental airworthiness certificate. If it does, then further analysis must be performed regarding overflight permits, insurances, operational restrictions etc before the application is approved.

The ITSB investigation did not reveal any Icelandic audit, restriction or special approval provided in conjunction with the flight testing program of the accident aircraft at Keflavik Airport in Iceland, except the approved overflight in Icelandic airspace and landing in Iceland provided by the Icelandic Ministry of Foreign Affairs.

Following the opening of this investigation the the Icelandic Ministry of Foreign Affairs has ammended its internal procedures regarding the approval of overflight in Icelandic airspace and landing permits in Iceland.

## **2.2. Flight operation**

According to the FDR data, 9 approaches had been performed with go-arounds during the last flight that started at 04:00. The first 7 approaches were made to RWY 20 and the last 2 approaches were made to RWY 11.

The objective of flight test #978 was to simulate CAT IIIA automatic approach and then to assess the AFCS performance in FD mode during go-around from radio altitude of 2-3 feet, close to the airplane's maximum landing weight limit, with the right engine shut down and crosswind exceeding 10 m/s (19.5 knots). This was done as part of extending the type certificate to CAT IIIA certification.

For the initiation of automatic go-around, the TOGA button must be engaged prior to touching the runway. Otherwise manual go-around will be required. This is because touching the runway leads to main landing gear strut compression which signals WOW (weight on wheels) to complex avionics hardware on the aircraft. In accordance with EASA AMC<sup>48</sup> AWO 316, section "1.2 inadvertent go-

---

<sup>48</sup> Acceptable Means of Compliance

around Selection”, an inadvertent selection of go-around mode after touchdown should have no adverse effect on the ability of the aircraft to safety rollout and stop. As a result of this EASA design requirement, the TOGA switches are automatically disengaged after touchdown to prevent inadvertent selection of go-around mode after landing.

### **2.2.1. The planned execution of flight test #978**

At circling height<sup>49</sup> the flight crew was to set the critical (right) engine switch on the ATTCS TEST PANEL to FAULT (see Figure 2).

The AP, A/T and FD were all to be selected ON as part of the flight test.

At a 20-25 feet radio altitude the flight crew was then to set the critical (right) engine TQL to IDLE or shut off the critical engine using the ATTCS TEST PANEL.

Just before the airplane had descended down to minimum go-around altitude<sup>50</sup> the flight crew had to switch off the AP to imitate autopilot failure. Then, in accordance with AFCS operation logics, the AP mode disengages, but according to the test setup the FD bars should still display on PFD<sup>51</sup> and the aircraft should remain in flight director mode with the A/T engaged.

After an aural and light indication of the AP disengaging, the flight crew was to perform go-around by either of the two following options:

- a) At minimum go-around altitude by pressing the TOGA button on one of the two TQL's
- b) In case of touch down, prior to pressing the TOGA button, manual control was required for the go-around

### **2.2.2. The actual execution of flight test #978**

Before final approach, as part of the flight test procedures, the flight certification expert sitting in the jump seat in the cockpit selected right engine failure on the

---

<sup>49</sup> Aerodrome pattern flight altitude, before final approach

<sup>50</sup> HGA, which was 2-3 feet radio altitude for this test

<sup>51</sup> Primary Flight Display

ATTCS Test Panel located on the pedestal before approach. The investigation showed this action to be a part of the flight test.

The investigation revealed that during the final approach, when the accident occurred, the AP was selected ON, both the left and right A/T were selected ON and the FD was selected ON.

During the final approach both the left and right TLQ were being moved between 10 deg and 18 deg by the A/T for stable approach.

At 05:23:25 in accordance with AFCS logic at radio altitude  $H_{RA}=17\text{ft}$  in response to a signal "RETARD" left and right TQL have started to move to IDLE.

At 05:23:26, when the airplane was at radio altitude of about 10 feet, the flight certification expert sitting in the jump seat shut down the right engine using the ENG MASTER SWITCH. The investigation showed this action to be a part of the flight test.

At 05:23:26.5, after the right engine was shut off, the right A/T disconnected and the right TQL stopped moving to idle, staying at  $13.6^\circ$ , while the left A/T continued moving the left TQL back to idle.

At this time the AP was selected ON, the FD was selected ON and the left A/T was selected ON, while the right A/T was selected OFF.

At 05:23:27 at radio altitude of about 4ft the pilot flying pressed the SS/PRIOR/AP OFF button on his side stick to disengage the autopilot. This caused disengagement of all AP/FD control modes and the left A/T reverted to SPEED mode. When the left A/T reverted to SPEED mode, the left TQL had already reached IDLE. At that time the airplane speed had reduced down to 139 knots, which was below the "limit selectable speed" of 143 knots. The left A/T therefore started moving the left TQL forward. The investigation showed this action to be part of the flight test to imitate autopilot failure. When the AP disengaged, both aural and light indication appeared, signaling the pilot flying to engage TQL TOGA button to initiate a go-around. At this time the left A/T was selected ON, while the AP, FD and the right A/T were selected OFF.



The pilot flying pressed the TOGA button on the right TQL to initiate a go-around and, according to the cockpit voice recorder, called out “go-around.”

Almost simultaneously, at 05:23:28:70, the main landing gear touched the RW and as a result of left main LG shock strut compression a/c avionics complex received WOW (weight on wheels) signal.

In response to WOW signal and in accordance with AFCS logic and SC AWO 316 requirements, the left A/T disengaged automatically. At the moment of left A/T disengagement, the left engine TQL was at 16.59°.

The pilot flying noticed at the primary flight display that the go-around mode had not engaged. He also noticed that the flight director was not available.

After the AP disconnected, the pilot flying attempted go-around by pressing the TOGA button on the right throttle immediately prior to the landing gear touching the runway at 05:23:28.7. The FTI<sup>52</sup> recorded a short “pulse” of GA mode engagement, which confirms that the signal from the TOGA button reached the auto flight system and its attempt to engage the GA mode on this computational step.

At 05:23:29.5, the left LG WOW status appeared. Therefore, in accordance with the auto flight system logics, the A/T system was disconnected. GA engagement was inhibited by an asynchronous acquiring of WOW status by the two auto flight system master channel computers. The GA was not displayed in PFD. So, at 05:23:29.5 the following events had simultaneously occurred:

Actual landing touchdown, A/T disconnect and GA mode engagement inhibit.

The main landing gear only touched the runway at 05:23:28:70 for a brief moment (0.4 seconds) and then the airplane started to climb again at 05:23:29:10.

---

<sup>52</sup> Flight Test Instruments

At 05:23:30 the right engine's SOV<sup>53</sup> closed as it had previously been set to failure mode by the ATTCS panel and shut down using the ENG MASTER SWITCH.

At this point the AP, the FD, the left A/T and the right A/T were all selected OFF, as was the right engine. The left engine was delivering thrust at TQL 16.59°, slightly higher than idle. Manual input from the operational engine (left engine) was therefore required to perform the go-around.

The pilot flying started to perform go around in manual mode, by setting the right (inoperative) engine TQL to TO/GA.

The pilot flying pitched the airplane up and the airplane started climbing. According to the CVR, no POSITIVE CLIMB callout was made. The pilot flying ordered landing gear retraction at 05:23:34. The landing gear was selected to up at 05:23:36 by the pilot monitoring.

The left TQL remained at 16.59 deg, until the pilot flying discovered his mistake two seconds before the airplane hit the runway and put the left TQL to TO/GA. By then, the throttle input on the left engine was too late.

The fuselage aft lower belly of the aircraft hit the runway at 05:23:47, as the landing gear was in its UP position.

### **2.2.3. Crew qualification**

The investigation did not indicate crew qualification to be a factor in the accident.

### **2.2.4. Operational procedures**

The flight testing of the airplane was being performed per the requirements of the Federal Aviation Regulations (FAR) for experimental flights of the Russian Federation.

The setup of the flight test program was such that part of the test pilot flight crew was provided by the Russian Flight Research Institute.

---

<sup>53</sup> Shut Off Valve

At the time of the accident the flight crew was performing flight test #978. This flight test had been signed off by the Head of Flight and Test Complex of Sukhoi Civil Aircraft. The flight test involved the evaluation of the flight automatic control system in “Autopilot landing mode” with the AP and FD engaged during missed approach.” The flight test protocols were detailed and provided step by step instructions on what was to be accomplished.

The flight crew was using printed copy from Jeppesen e-Link 2.2.1.0 for airport charts on BIKF/KEF Keflavik Airport. These charts were printed on June 24<sup>th</sup> 2013, the day before the airplane was flown to Iceland for the flight testing.

#### **2.2.5. Weather**

The investigation did not indicate weather to be a factor in the accident.

#### **2.2.6. Air traffic control**

The flight crew was in contact with both ATC Approach and the ATCO<sup>54</sup>, for Keflavik Tower, during the approach to RWY 11 before the accident occurred.

The flight crew requested and was granted by the Keflavik Airport ATCO, touch and go approval for RWY 11 at 05:21:13.

Section 3 in BIKF AD.2.21 of the Icelandic AIP states:

*“Touch and go’s or low approaches will not be approved for runways 11/29 between 22:00 and 07:00 hours.”*

According to the Icelandic Transport Authority, no approval had been granted for diversion from the AIP for the crosswind testing.

Details on this nighttime restriction could also be found in the printed copy from Jeppesen e-Link 2.2.1.0 for airport charts on BIKF/KEF Keflavik Airport that the flight crew used.

---

<sup>54</sup> Air Traffic Control Officer

### **2.2.7. Communication**

According to the cockpit voice recorder, active communications regarding the flight took place between the flight crew members during the approach and up to touch down.

After the touchdown (05:23:28.70), and before the airplane hit the runway with the landing gear retracted (05:23:47), cockpit crew communications were mainly in Russian and were indistinct. The only well-defined communications observed between the flight crew members with regards to the flight during this period was the gear up command and its confirmation.

### **2.2.8. Aids to navigation**

The investigation did not indicate that navigation equipment was a factor in the accident.

### **2.2.9. Aerodrome**

Section 1 in BIKF AD.2.21 of the Icelandic AIP states:

*“A right hand traffic pattern shall be flown for RWYs 11& 20 unless otherwise approved or instructed by ATC.*

*Noise abatement departures for runway 11:*

*11A: Climb runway heading to 800 feet then turn right heading 130° and maintain until reaching 2000 feet.*

*For aircraft not able to comply with the above:*

*11B: Climb runway heading until reaching 2000 feet.”*

The investigation revealed that the flight testing of an airplane on RWY 11 at Keflavik Airport would take the airplane over populated residential area in Innri-Njarðvík, Reykjanesbær, at minimum clearance altitude with one engine inoperative, during the take-off section of the testing. See Figure 17 and Figure 18 for details.



Figure 17: Calculated track from takeoff to 800 feet altitude under test condition



Figure 18: Turn based on right turn at 800 feet altitude for 20° / 30° bank angle

According to Isavia<sup>55</sup>, in relation to this accident, an in-house task group has been formed to evaluate the use of BIKF airport for flight certification testing. The purpose of this task group is to suggest procedures for flight certification flight testing at the airport. These procedures will address the following issues:

- Time of day these flights can be operated
- To direct these flights away from populated areas
- To designate flight patterns, to ensure increased safety of the surrounding populated areas
- To ensure that the airport has sufficient emergency equipment
- To review the airport's staff training

### **2.3. Aircraft**

Sukhoi Civil Aircraft airplane type RRJ-95B was EASA validated under type certificate EASA.IM.A.176 and must therefore meet EASA CS-25<sup>56</sup>.

The regulations regarding the emergency escape slides, EASA CS-25.810(iv) Emergency egress assisting means and escape routes, state:

*“It must have the capability, in 46 km/hr (25-knot) winds directed from the most critical angle, simultaneously with any engine(s) running at ground idle, to deploy and, with the assistance of only one person, to remain usable after full deployment to evacuate occupants safely to the ground.”*

According to the Icelandic Meteorology Office, at the time of the accident the wind at Keflavik Airport was 18-21 knots. Therefore the forward right emergency escape slide that blew under the airplane fuselage did not meet its required design criteria.

#### **2.3.1. Aircraft maintenance**

The investigation did not indicate aircraft maintenance to be a factor in the accident.

---

<sup>55</sup> The operator of Keflavik Airport (BIKF)

<sup>56</sup> Certification Specification for Large Aeroplanes

### **2.3.2. Aircraft performance**

The investigation did not indicate aircraft performance to be a factor in the accident.

### **2.3.3. Mass and balance**

The investigation did not indicate mass and balance to be a factor in the accident.

### **2.3.4. Aircraft instrumentation**

The investigation did not indicate aircraft instrumentation to be a factor in the accident.

### **2.3.5. Aircraft systems**

The investigation did not indicate aircraft systems to be a factor in the accident.

## **2.4. Human Factors**

The ITSB investigation revealed that human factors played a significant role in this accident.

### **2.4.1. Pressure – One flight crew with limited on duty rotation**

The pilot flight test team consisted of five pilots. Of those, three pilots were located in Iceland at a time<sup>57</sup>.

Four of the five pilots participated in a pilot rotation program. The last test pilot rotation change had been on July 18<sup>th</sup>, when the Sukhoi Civil Aircraft test pilot in the left pilot seat of the accident flight (pilot monitoring) had arrived to replace a test pilot from the Russian Flight Research Institute.

The pilot flying during the accident flight, who was also the pilot in command, had not been in the pilot rotation program. He had been on duty throughout the whole flight test program. This was his 30<sup>th</sup> flight, as a pilot, since the aircraft left Russia for the flight test program in Iceland on June 25<sup>th</sup>, less than a month earlier.

---

<sup>57</sup> LH seat, RH seat and jump seat

#### 2.4.2. Fatigue – Extended duty

According to Russian Federal Aviation Regulation<sup>58</sup> for experimental flights, test pilot is allowed to conduct test flight, including both preflight period and test flight duration, for a period not exceeding 8 hours.

After the accident, the Head of Flight Tests division of Sukhoi Civil Aircraft issued a declaration note stating the following flight shifts leading up to the accident:

*8:30 -10:00 – preliminary preparations to flight in the hotel;*  
*10:00 – 12:00 – rest in the hotel;*  
*12:00 – 13:00 – lunch in the hotel;*  
*13:00 – 18:00 – rest in the hotel;*  
*18:00 – 18:30 – dinner in the hotel;*  
*18:30 – 19:00 – transfer to the airport;*  
*19:00 – 19:35 – preflight training;*  
*19:35 – 19:45 – transfer to the aircraft.*  
*19:57 – 21:40 – first flight № 975;*  
*22:35 – 00:24 – second flight № 976;*  
*01:16 – 03:07 – third flight № 977;*  
*04:03 – 05:2 – forth flight № 978.*

During the on-site investigation it was noted by the ITSB investigators that the flight crew was reported severely fatigued. Shortly thereafter, the ITSB interviewed the flight crew. Fatigue was reported in the interviews, where it was stated that all the crew was both mentally and physically tired.

The ITSB investigated the flight crew work schedule and located the following schedules sent from the Sukhoi test team in Iceland to the airport handling agent:

**a) Original flight schedule – Sent on July 19<sup>th</sup> at 20:24:**

- *Arriving at airport gate: 12:15 on July 20<sup>th</sup>*
- *First flight (#975): 14:00 – 15:45 on July 20<sup>th</sup>*
- *Second flight (#976): 16:30 – 18:15 on July 20<sup>th</sup>*

---

<sup>58</sup> Chapter 3.11.1 of Annex to Rosaviacosmos order no. 104, dated June 28th, 2000



- *Third flight (#977): 19:00 – 20:45 on July 20<sup>th</sup>*
- *Fourth flight (#978): 21:30 – 23:15 on July 20<sup>th</sup>*

This was a duty time of 11 hours, from the time they arrived at the airport and until the end of the last flight.

**b) Revision 1 flight schedule – Sent on July 20<sup>th</sup> at 14:07:**

*„Pls be advised that all flight for Sukhoi Superjet for today are delayed for two hours.“*

The schedule therefore changed to:

- *First flight (#975): 16:00 – 17:45 on July 20<sup>th</sup>*
- *Second flight (#976): 18:30 – 20:15 on July 20<sup>th</sup>*
- *Third flight (#977): 21:00 – 22:45 on July 20<sup>th</sup>*
- *Fourth flight (#978): 23:30 on July 20<sup>th</sup> – 01:15 on July 21<sup>h</sup>*

It was noted that this change in the schedule was sent in a time period when the flight crew was stated being in the hotel resting.

**c) Revision 2 flight schedule – Sent on July 20<sup>th</sup> at 15:58:**

*„Pls be advised that all flights for Sukhoi Superjet for today are delayed again for two hours each.“*

The schedule therefore changed to:

- *First flight (#975): 18:00 – 19:45 on July 20<sup>th</sup>*
- *Second flight (#976): 20:30 – 22:15 on July 20<sup>th</sup>*
- *Third flight (#977): 23:00 on July 20<sup>th</sup> – 00:45 on July 21<sup>h</sup>*
- *Fourth flight (#978): 01:30 – 03:15 on July 21<sup>h</sup>*

It was noted that this change in the schedule was also sent in a time period when the flight crew was stated being in the hotel resting.

**d) Revision 3 flight schedule – Sent on July 20<sup>th</sup> at 17:30:**

*„Pls be advised that all flights for Sukhoi Superjet for today are delayed again for 0130 each.“*

The schedule therefore changed to:

- *First flight (#975): 19:30 – 21:15 on July 20<sup>th</sup>*
- *Second flight (#976): 22:00 – 23:45 on July 20<sup>th</sup>*
- *Third flight (#977): 00:30 – 02:15 on July 21<sup>h</sup>*
- *Fourth flight (#978): 03:00 – 04:45 on July 21<sup>h</sup>*

It was noted that this change in the schedule was also sent in a time period when the flight crew was stated being in the hotel resting.

**e) Revision 4 flight schedule – Sent on July 20<sup>th</sup> at 22:44:**

Request for change to the flight schedule was made. This was done because refueling was required prior to the 3<sup>rd</sup> flight and also for a loading belt to be provided prior to the 4<sup>th</sup> flight. The ITSB investigation revealed that the loading belt was needed as sandbags had to be installed prior to the 4<sup>th</sup> flight as that flight test required the airplane to be close to its MLW.

The schedule therefore changed to:

- *Refueling request 00:25*
- *Third flight (#977): 00:50 – 02:35 on July 21<sup>h</sup>*
- *Loading belt 02:30*
- *Fourth flight (#978): 03:00 – 04:45 on July 21<sup>h</sup>*

**f) Revision 5 flight schedule – Sent on July 21<sup>th</sup> at 04:32:**

Confirmation of the final flight schedule provided, due to delays both before the 3<sup>rd</sup> and the 4<sup>th</sup> flight.

The schedule therefore changed to:

- *First flight (#975): 19:40 – 21:50 on July 20<sup>th</sup>*
- *Second flight (#976): 22:25 on July 20<sup>th</sup> – 00:35 on July 21<sup>st</sup>*
- *Third flight (#977): 01:10 – 03:20 on July 21<sup>st</sup>*
- *Fourth flight (#978): 03:55 – 06:20 on July 21<sup>st</sup>*

Analysis of the above schedules showed the following:

- The accident occurred 10 hours and 53 minutes after the flight shift of the flight crew did actually start according to a declaration issued by the Head of Flight Tests division of Sukhoi Civil Aircraft
- The accident occurred 17 hours and 8 minutes after the original shift of the flight crew was to have started at 12:15 on July 20<sup>th</sup>.
- The accident occurred 20 hours and 53 minutes after the preliminary preparation for the flight started in the hotel at 08:30 in the morning of July 20<sup>th</sup>.

The investigation revealed that the flight crew exceeded their maximum duty time. This was done because the time for flight test campaign was about to finish and the weather forecast for the following 3 days did not have suitable weather conditions for the flight test program.

To comply with Russian Federal Aviation Regulation for experimental flights, the ITSB determined that the flight crew should have stopped the flight testing prior to the third test flight (flight test #977).

Performance decrements associated with periods of prolonged wakefulness have been addressed in multiple research literature. Research<sup>59</sup> has shown that performance on cognitive tasks, mental problem solving, vigilance and communication tasks shows a 30% decrement after 18 hours of wakefulness. After 42 hours, performance degrades by 60%. Performance degradation is therefore progressive, becoming worse as time awake increases.

---

<sup>59</sup> R.G. Angus et al., "Sustained Operations Study: From the Field to the Laboratory," *Why We Nap: Evolution, Chronobiology and Functions of Polyphasic and Ultrashort Sleep*, ed. C. Stampi (Boston: 1992), pp. 217-241.

Based on the above research and with respect to the preliminary flight preparation starting at 08.30 in the morning of July 20<sup>th</sup>, ITSB fatigue calculations estimated the task performance of the flight crew to have degraded approximately 46% at the time of the accident.

One of the more sensitive measures of performance degradation due to the fatigue associated with continuous wakefulness is reaction time<sup>60</sup>. People who are fatigued, reliably react more slowly to situations and stimuli that require rapid cognitive or physical responses.

The ITSB determined that flight test #978 requires both rapid cognitive and physical responses on behalf of the pilot flying.

Performance and cognitive functioning also follow a circadian rhythm<sup>61</sup>. People who work after midnight demonstrate impairments in these functions<sup>62, 63</sup>. Performance and cognitive functioning are at their lowest when the person is usually asleep. Performance on specific measurements such as random number addition speed (RNAS)<sup>64</sup>, arithmetic and signal detection<sup>65</sup>, and train safety alarm alerts<sup>66</sup>, all demonstrate the worst performance during the night shift.

At the time of the accident the pilot flying had spent close to one month in Iceland. Therefore the ITSB determined that the pilot flying had adjusted to the Icelandic time zone.

---

<sup>60</sup> Tilley, A. J., Wilkinson, R. T., Warren, P. S. G., Wastson, B., & Drud, M. (1982). Human Factors, 24, 629-641

<sup>61</sup> Monk, T. H. (1988). Shiftwork: Determinants of coping ability and areas of application. *Advance in the Biosciences*, 73, 195-207

<sup>62</sup> Baddeley, A. D., & Hitch, G. (1974). Working memory. In *The psychology of learning and motivation: Advances in research and theory* (Vol. 8, pp. 47-89). New York: Academic Press

<sup>63</sup> Folkard, S., Knauth, P., Monk, T. H., & Rutenfranz, J. (1976). The effect of memory load on the circadian variation in performance efficiency under a rapidly rotating shift system. *Ergonomics*, 19, 479-488

<sup>64</sup> Gupta, S., & Pati, A. K. (1994). Desynchronization of circadian rhythms in a group of shift working nurses: effects of pattern of shift rotation. *Journal of Human Ergology*, 23(2), 121-131

<sup>65</sup> Tepas, D. I., Walsh, J. K., & Armstrong, D. R. (1981). In L. C. Johnson, D. I. Tepas, W. P. Colquhoun, & M. J. Colligan (Eds.), *Biological rhythms, sleep and shift work* (pp. 347-356). New York: Spectrum Publishing

<sup>66</sup> Hildebrandt, G. Rohmert, W., & Rutenfranz, J. (1974). Twelve and twenty-four hour rhythms in error frequency of locomotive drivers and the influence of tiredness. *International Journal of Chronobiology*, 2, 97-110

The accident occurred during night at 05:23, at the time of day when the performance and cognitive function of the pilot flying would have been at its low point per the above analysis.

An indicator of flight crew fatigue was that standard callouts were not made when initiating the go-around.

The pilot flying attempted the go-around with the use of the inoperative engine TQL and 15 seconds passed before he corrected this.

Fatigue is known<sup>67</sup> to affect the short-term memory. It affects the short term memory in such way that it degrades the capability to register and retrieve information correctly. It is therefore possible that when the right engine was made inoperational, the pilot flying did not register it correctly in the short-term memory due to fatigue.

## **2.5. Survivability**

The emergency escape slide of the forward left door did not deploy when the door was opened by a cockpit crew member. Inspection of the arming handle revealed that the door's emergency escape slide had not been set to the armed position. See Figure 15 for details.

Before the forward right door was opened, the emergency escape slide was armed. When the door was opened the emergency escape slide deployed, but due to the crosswind it blew underneath the belly of the airplane and was rendered unusable. The investigation showed that the emergency escape slide did not meet EASA CS-25.810(iv) design requirements and was twisted upside-down in its position under the airplane's belly. See Figure 19 for details.

---

<sup>67</sup> UK CAA (2003), CAP 716, Aviation Maintenance Human Factors, Chapter 3.1

**EXIT SLIDE**

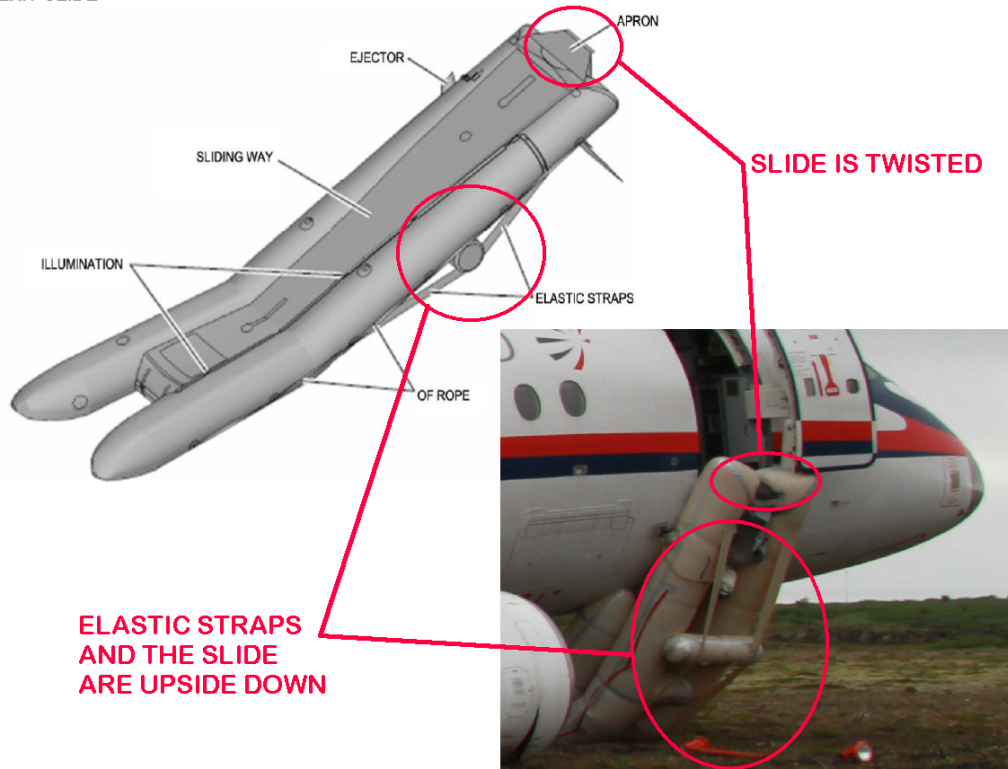

**Figure 19 Right forward door slide twisted upside down and under fuselage belly**

According to the AFM checklist for emergency evacuation on ground, the flight crew is to REPORT to ATC their intentions to evacuate the airplane. See Figure 20 for details. No such report was made to ATC by the flight crew.

<b>4</b>	A-00	<b>EMERGENCY AND ABNORMAL PROCEDURES</b>	 <b>SUKHOI</b> <small>Сухой Авиационный Корпорация</small> <b>RRJ-95B</b> Flight Crew Operating Manual
	4.80	OTHER EMERGENCY AND ABNORMAL PROCEDURES	

**EMERGENCY EVACUATION ON THE GROUND**

- AIRCRAFT ..... STOP
- PARKING BRAKE ..... ON
- ATC ..... REPORT
- ENG MASTER..... OFF
- CABIN ..... INFORM
- EMER D-PRESS .....ON
- ENG FIRE (L+R) AND APU FIRE BUTTONS ..... PRESS
- AGENTS 1 (L+R) AND APU BUTTONS ..... PRESS
- EVACUATION ..... START

**Figure 20 Flight crew is to report to ATC**

### **2.5.1. Rescue service response**

The airport fire department was notified of the accident by the Keflavik Airport tower ATCO at 05:24:10, 23 seconds after the aircraft aft lower fuselage hit the runway. The first of three fire engines from the fire rescue service was at the accident site about three minutes after the accident.

### **2.5.2. Analysis of injuries and fatalities**

One crew member fractured his right ankle during the evacuation of the aircraft.

### **2.5.3. Survival aspects**

The ITSB investigated why the emergency plan was not activated until 8 minutes and 49 seconds after the Sukhoi aircraft hit the runway.

At 05:24:26 the Keflavik Airport tower ATCO contacted the Keflavik Airport approach ATCO and requested that he activated the emergency services<sup>68</sup>, therefore activating the airport's emergency plan<sup>69</sup>. Six seconds later, during the same telecom conversation, the tower ATCO recalled the request as it was deemed unnecessary.

At 05:29:20 the Keflavik Airport tower ATCO contacted the Keflavik Airport approach ATCO to discuss the activation of the airport's emergency plan. Again, it was deemed unnecessary to activate of the airport's emergency plan.

The ITSB determined that these decisions were influenced by the facts that there were few people on board and there was no fire.

The airport's emergency plan was not activated until the airport's fire department contacted the tower ATCO to inquire into the status of the ambulances. This was 8 minutes and 49 seconds after the Sukhoi aircraft hit the runway.

Figure 21 provides details on a single Tetra emergency group communication the airport's ATC is to initiate to activate the emergency plan.

---

<sup>68</sup> 112

<sup>69</sup> Flugslysaáætlun fyrir Keflavíkurlugvöll, útgafið af Almannavörnum

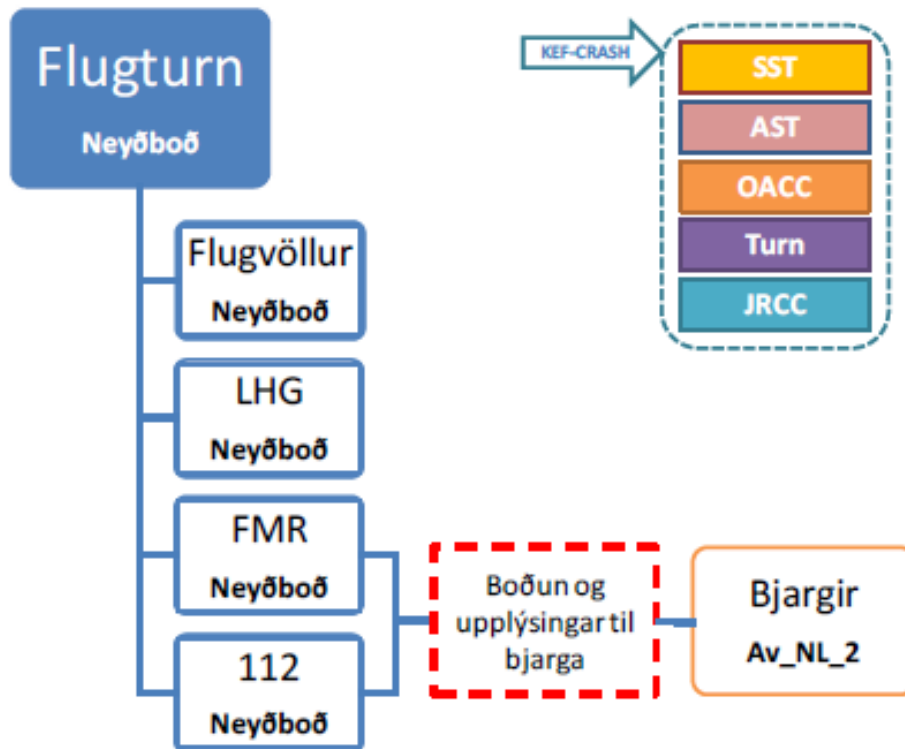

Figure 21<sup>70</sup>: The ATC tower personnel (Flugturn) should issue an emergency communication (Neyðarboð on call group “KEF-CRASH”) to:

- Airport Fire Department and Airport Control Center (Flugvöllur)
- Coast Guard (LHG)
- Police Communication Center (FMR)
- Emergency Services (112)

The airport emergency plan was activated as “Alert Phase / Yellow”<sup>71</sup> and ambulances requested. Additional details were then provided of an injured person, 7 souls on board, no fire, fire department already at site and that the accident occurred about 10 minutes ago.

The definition from the airport emergency response plan is twofold, i.e. phase of the emergency and its color code, as follows:

<sup>70</sup> Chapter 4.0 of „Flugslysaáætlun fyrir Keflavíkurflugvöll“

<sup>71</sup> Hættustig - Gulur



Phases:

- Uncertainty Phase – Situation where the safety of an aircraft and the people on board is uncertain.
- Alert Phase – Situation where the safety of an aircraft and the people on board is in jeopardy.
- Distress Phase – Situation where it is known that an aircraft is in serious, or imminent, distress and the people on board require immediate assistance. An example is an aviation accident on land.

Color code:

- Green – The scale of rescue operation can be handled with the resources in the district. This assumes 5 or less souls are on board the aircraft.
- Yellow – The scale of rescue operation can be handled with the resources in the district along with selective resources from outside the district. This assumes 6-55 souls are on board the aircraft.
- Red – The scale of rescue operation requires the resources in the district along with additional resources from outside the district. This assumes 56 or more souls on board the aircraft and that the rescue operation requires centralized coordination.

The reason for “Yellow” to be selected, while there were only 5 souls on board the airplane, the ITSB determined to be that 7 people were filed on the flight plan to ATC prior to the flight shift commencing. The correct selection of color code would have been green.

The investigation determined that the use of green color code has however on several occasions caused confusion during activation of the emergency plan.

The reason for “Alert Phase” to be selected, the ITSB determined to be that the airplane was already outside the runway. The correct selection, according to the airport’s emergency plan, would have been Distress Phase<sup>72</sup> as an aircraft accident had already occurred.

---

<sup>72</sup> Neyðarstig

The ITSB investigated if there was a lack of knowledge on the Keflavik Airport tower ATCO behalf's in how to activate the emergency plan. This investigation determined that the tower ATCO had, at least on two previous occasions, activated the airport emergency plan with exemplary performance.

The ITSB therefore investigated why this case was different.

In the other two emergencies, the commander of the aircraft under the emergency issued an emergency communication (MAYDAY-MAYDAY-MAYDAY) to the tower ATCO. In this case, no such emergency communication was provided by the Sukhoi's commander. The ITSB therefore determined that the trigger for the emergency (MAYDAY-MAYDAY-MAYDAY) that the tower ATCO was used to, was lacking in this accident.

The ITSB looked into training for Keflavik Airport tower ATCO personnel. Regular desk training exercises do not include the use of communication equipment, in addition the setup of the training does not represent the layout of Keflavik Airport tower.

The ITSB looked into Isavia Airports Aviation Accident Training Exercise Program. The last scheduled aviation accident training exercise was held at Keflavik Airport on 5 May 2012. This was 14 months prior to the accident. During this airport accident training the emergency plan of the airport was activated under "Alert Phase / Yellow" after a large fire had been lit. The ITSB researched the subsequent scheduled aviation accident training exercises performed at airports around Iceland operated by Isavia. In all instances the ITSB determined that the emergency plan of the airports was activated by the airport tower personnel after a fire has been set during the accident training.

The ITSB understands the need of fire during those scheduled airport accident training exercises, as important part of the training involves for the airport's fire brigade. The ITSB therefore raised the question on what can be done to ensure that such pre-emptive training trigger will not lower the situational awareness on the ATCO personnel in actual emergency situations where no fire is present.

The investigation determined that Isavia is already aware of this problem after this accident and is working to include Operational Awareness<sup>73</sup> training into the re-current training program of its ATC officers. The ITSB commends Isavia on the proactive approach to this problem. At the same time the ITSB emphasizes the importance that such training be performed on the basis of just culture / no blame policy, so that the ATC personnel positively react to the training and embrace it.

---

<sup>73</sup> Aðgerðarvitund

### 3. Conclusion

Sukhoi Civil Aircraft RRJ-95B of Russian experimental registry 97005 was a civil aircraft on experimental registration and should have been treated as such by the ICAO standards per the rules and regulations of the Icelandic Transportation Authority. Therefore, it should not have been classified as a State Aircraft by the Icelandic Ministry of Foreign Affairs.

The ITSB believes that changes to the flight test program on the 20<sup>th</sup> of July would not have been made without the knowledge of the commander of the flight test program, who was the pilot flying during the accident. This would also have limited the pilot's flying, who also was the pilot in command, ability to rest properly between 13:00 and 18:00 on July 20<sup>th</sup> as frequent changes to the flight test program schedule were made.

The accident occurred 20 hours and 53 minutes after the preliminary preparation for the flight started in the hotel at 08:30 in the morning of July 20<sup>th</sup>.

The accident occurred 17 hours and 8 minutes after the original shift of the flight crew was to have started at 12:15 on July 20<sup>th</sup>.

The accident occurred 10 hours and 53 minutes after the flight shift of the flight crew did actually start.

The same three test pilot flight crew had been on duty the whole time.

The pilot flying / pilot in command during the accident flight had participated in every test flight performed in the test flight program in Iceland.

According to Russian Federal Aviation Regulation for experimental flights, a test pilot is allowed to conduct a test flight, including both preflight period and test flight duration, for a period not exceeding 8 hours. The flight crew was outside its allowed flight test duty time.

To comply with Russian Federal Aviation Regulation for experimental flights, the ITSB determined that the flight crew should have stopped the flight testing prior to the third test flight (flight test #977).

The ITSB concludes that although the flight crew was well rested prior to the originally planned flight duty time, it was not well rested at the time of the actual flight duty time due to significant and repeated delays. ITSB fatigue calculations estimated the task performance of the flight crew to have degraded approximately 46% at the time of the accident.

The investigation revealed that the flight crew exceeded the maximum duty time, because the time for flight test campaign was about to finish and the weather forecast for the following 3 days did not have suitable weather conditions for the flight test program.

The flight test was performed on RWY 11, which was not authorized for touch and go's or low approaches during the flight test time per the Icelandic AIP.

The emergency escape slides were not armed prior to the flight, which affected the time it took to evacuate the airplane.

The forward right door emergency escape slide did not meet EASA CS-25.810(iv) design requirements.

The decision of the Keflavik Airport tower ATCO not to activate the airport's emergency plan, until the airport's fire department contacted the tower to ask the status of the ambulances, severely affected the response time of the ambulance sent by the emergency services as well as the response time of other parties of the emergency plan. The ITSB determined this decision to be caused by insufficient Operational Awareness on behalf of the tower ATCO personnel. Following this accident, Isavia is amending the re-current training of its ATC personnel by adding an Operational Awareness course.

The investigation revealed that flight testing of an aircraft on RWY 11 at Keflavik Airport would have taken the aircraft over populated residential area in Innri-Njarðvík in Reykjanesbær at low altitude, during the take-off section of the testing. In this particular flight test this was planned in 18-21 knots crosswind condition, with one engine out, near the airplane's maximum landing weight, outside the approved flight testing crew duty time, with severely fatigued flight crew and no safety authority oversight.

The ITSB would have liked to make the following safety recommendation to ICAO, but due to some nations not following ICAO protocol regarding CVR confidentiality it is withheld at this time:

“For aircraft accident investigation purposes, research the drawbacks and benefits of installing cockpit video recording system into commercial aircraft, currently fitted with CVR.”

The ITSB believes the following to be contributing factors to the accident:

- The left A/T was automatically disengaged when the left TQL was at 16.59°, at the moment of touchdown, which was an insufficient thrust setting for go-around
- The right engine was shut off and right engine A/T was disengaged, in accordance with the flight test card, at the moment of setting ENG R MASTER SWITCH to OFF
- Advancing the inoperative engine TQL, resulted in insufficient engine power being available for the go-around

The ITSB determined the most probable cause of the accident to be flight crew fatigue.

#### **4. Safety Recommendations**

The Icelandic Transportation Safety Board issues the following safety recommendations:

##### Sukhoi Civil Aircraft:

- 1) Ensure sufficient resources for flight dispatch operation, independent of the flight crew, during flight tests
- 2) Review the flight test program and take the necessary steps to ensure that arming of door slides is performed prior to flight
- 3) Clarify the AFM procedures to require both TQLs to be operated in cases where a failed engine has not been identified and secured

##### Isavia:

- 4) Take the necessary steps to ensure that Keflavik Airport's emergency plan is activated without a delay, following an accident occurrence
- 5) Take the necessary steps to ensure that the AIP is adhered to
- 6) Set up formal procedures for Flight Certification / Flight Testing at the BIKF airport, based on the work of the in-house task group

##### ICETRA:

- 7) Set up a procedure for approval of Flight Certification / Flight Testing that are performed at Icelandic airports and in Icelandic airspace. The procedure should ensure that the airport/ATC service provider (Isavia) is informed/consulted as applicable

##### Russian Ministry of Industry and Trade:

- 8) Ensure that on-site flight certification officers maintain an independent auditing role from the flight crew of the manufacturer

##### The Interstate Aviation Committee and EASA:

- 9) In conjunction with the manufacturer, ensure that necessary changes are made to the emergency escape slide design of RRJ-95B aircraft EASA certified under type certificate EASA.IM.A.176 to meet the maximum wind requirements of EASA CS-25.810(iv)

Safety Action:

Ministry of Interior:

Revise regulation article 4(a) of regulation 650/2009 to change the color code green to another color

The following board members approved the report:

- Geirprúður Alfreðsdóttir, chairman
- Bryndís Lára Torfadóttir, board member
- Gestur Gunnarsson, board member
- Tómas Davíð Þorsteinsson, deputy board member
- Hörður Arilíusson, deputy board member

Reykjavik, 23. March 2016

On behalf of the Icelandic Transportation Safety Board  
Ragnar Guðmundsson, Investigator-In-Charge