

Revision 6

Xx xxxx 2021

Aerodrome Design Requirements:

- All Aeroplanes Conducting Air Transport Operations
- All Aeroplanes above 5700 kg MCTOW

General

Civil Aviation Authority (CAA) advisory circulars (ACs) contain information about standards, practices, and procedures that the Director has found to be an **acceptable means of compliance** with the associated rule.

Consideration will be given to other methods of compliance that may be presented to the Director. When new standards, practices, or procedures are found to be acceptable they will be added to the appropriate AC.

Purpose

This AC describes an acceptable means of compliance with Civil Aviation Rule Part 139 relating to aerodrome design requirements.

Focus

This material is intended for:

- applicants for the grant of and holders of an aerodrome operator certificate under the requirement of Civil Aviation Rule Part 139 *Aerodromes—Certification, Operation and Use*
- aerodromes used by aeroplanes conducting air transport operations under Part 121.

It is also recommended for any other aerodromes used by aeroplanes conducting air transport operations under Parts 125 and 135.

Related Rules

This AC relates to Part 139 - specifically rule 139.51.

Change Notice

Revision 6 amends a discrepancy with content in ICAO Annex 14 regarding stated pressures of an aircraft medium and high tyre pressure values referred to in the third table under section 2.5.6, *Maximum allowable tyre pressure category*, on page 20. It also takes the opportunity to add a Version History.

Published by
Civil Aviation Authority
PO Box 3555
Wellington 6140

Authorised by
Deputy Chief Executive Aviation Security and Infrastructure

Revision 5 incorporates changes to this AC in alignment with the current requirement of rule 139.51; updates the definition section; and makes minor editorial edits.

Version History

An outline of the changes are listed below:

AC Revision No	Effective Date	Summary of changes
AC 139-6, AC 121-2, AC 125-1, & AC 135-1, Rev 2	2 July 2007	<p>Updated with aerodrome standards and requirements for all aircraft in an air transport operation, and all aircraft with MCTOW above 5700 kg.</p> <p>Chapter 1 Definitions added as appropriate.</p> <p>Chapter 2 Aerodrome dimensions and related information updated to comply with ICAO.</p> <ul style="list-style-type: none"> • Information on coordination between aeronautical information services and aerodrome authorities added. • Tables on Aeronautical data quality requirements added. <p>Chapter 3 Code F requirements added</p> <ul style="list-style-type: none"> • Strip width requirements amended to correspond with Rules 135, 125 and 121. • Notes added for RESA in line with the Rule amendment. • Rapid exit taxiway requirements added. • Taxi-holding positions became Runway-holding positions. • Intermediate holding positions and road holding positions added. <p>Chapter 5 Fixed distance marking become Aiming point markings.</p> <ul style="list-style-type: none"> • Taxi-holding position marking becomes Intermediate holding position marking. • Road holding position, mandatory instruction, and information marking added. <p>Chapter 6 Includes Type A, B and C obstacle lights:</p> <ul style="list-style-type: none"> • Marking and lighting for overhead wires added. • ICAO requirements for location of obstacle

AC Revision No	Effective Date	Summary of changes
		<p>lights added.</p> <p>Chapter 7 Adding closed taxiway marking.</p> <p>Chapter 8 Circuit design requirements amended to conform to ICAO.</p>
AC 139-6, AC 121-2, AC 125-1, & AC 135-1, Rev 3	17 Nov 2009	Revision 3 updates the information under 'Runway designation marking' paragraphs 5.2.9 through 5.2.13, to clarify the designation of runways.
AC139-6, Rev 4	4 July 2011	<p>Incorporated some changes resulting from Amendment 10-A to ICAO Annex 14 Volume 1:</p> <ul style="list-style-type: none"> • Introduction of requirements for runway turn pads. • Introduction of de-icing/anti-icing facilities. • Requirements for enhanced taxiway markings. • Revision of runway end identifier lights to runway threshold identifier lights. • Amendment of the lighting requirements for starter extensions. <p>Added a new Appendix 4 on the requirements concerning design of taxiing signs and renames the existing Appendix 4 as Appendix 5.</p> <p>Removed reference in the title to the operating rules Parts 121, 125 and 135 to reflect that the purpose of this advisory circular is to specify design standards for aerodromes</p>
AC139-6, Rev 5	9 August 2016	<p>Incorporated changes in alignment with the current requirement of rule 139.51.</p> <p>Updated the definition section.</p> <p>Made minor editorial edits.</p>
AC139-6, Rev 6	Xx xxxx 2021	<p>Amends a discrepancy with content in ICAO Annex 14 regarding stated pressures of an aircraft medium and high tyre pressure values referred the third table under section 2.5.6, <i>Maximum allowable tire pressure category</i>, on page 20.</p> <p>Adds a Version History.</p>

Table of Contents

1. GENERAL	9
1.1 Introduction	9
1.2 Applicability	9
1.3 Definitions	9
1.4 Reference code	15
1.5 Summary of aerodrome requirements	16
2. AERODROME DATA	17
2.1 Aerodrome reference point	17
2.2 Aerodrome and runway elevations	17
2.3 Aerodrome reference temperature	17
2.4 Aerodrome dimensions and related information	17
2.5 Strength of pavement	18
2.6 Pre-flight altimeter check location	21
2.7 Declared distance	21
2.8 Disabled aircraft removal	22
2.9 Rescue and firefighting	22
2.10 Visual approach slope indication system	23
3.1 Runways	25
— Orientation and number	25
— Cross-wind factor	25
— Location of threshold	25
— Displaced threshold	26
— Actual length of runways	26
— Width of runways	27
— Separation of parallel runways	27
— Slopes on runways	28
— Strength of runways	29
— Surface of runways	29
3.2 Runway shoulders	29
— Width of runway shoulders	29
— Slopes on runway shoulders	30
— Strength of runway shoulders	30
3.3 Starter extension	30
— General	30
— Specifications	30
3.4 Runway turn pads	31
— General	31
— Slopes on runway turn pads	32
— Strength of runway turn pads	32
— Surface of runway turn pads	32
— Shoulders for runway turn pads	33
3.5 Runway strips	33
— General	33
— Length of runway strips	33
— Width of runway strips	33
— Objects on runway strips	33
— Grading of runway strips	34
— Slopes on runway strips	34
— Strength of runway strips	35
3.6 Runway end safety areas	35
— Strength of runway end safety areas	35
3.7 Clearways	35
— Location of clearways	35
— Length of clearways	36
— Width of clearways	36

—	Slopes on clearways	36
—	Objects on clearways	36
3.8	Stopways	36
—	Width of stopways	36
—	Slopes on stopways	36
—	Strength of stopways	37
—	Surface of stopways.....	37
3.9	Taxiways.....	37
—	General	37
—	Clearance distance on taxiways	37
—	Width of taxiways	38
	Taxiway curves.....	38
—	Junctions and intersections	38
—	Taxiway minimum separation distances	39
—	Slopes on taxiways	40
—	Strength of taxiways	40
—	Surface of taxiways.....	40
—	Taxiways on bridges	41
—	Rapid Exit Taxiways	41
3.10	Taxiway shoulders	42
3.11	Taxiway strips	42
—	Width of taxiway strips	42
—	Objects on taxiway strips	42
—	Grading of taxiway strips.....	43
—	Slopes on taxiways strip	43
3.12	Holding bays, runway-holding positions, intermediate holding positions and road-holding positions	43
—	General	43
—	Location	44
—	Low minima operations	45
3.13	Aprons	45
—	Size of aprons	46
—	Strength of aprons.....	46
—	Slopes on aprons.....	46
—	Clearance distances on aircraft stands.....	46
—	Aircraft to apron edge	47
3.14	Isolated aircraft parking position.....	47
3.15	De-icing/anti-icing facilities	47
—	General	47
—	Location	47
—	Size and number of de-icing/anti-icing pads.....	48
—	Slopes on de-icing/anti-icing pads.....	48
—	Strength of de-icing/anti-icing pads.....	48
—	Clearance distances on a de-icing/anti-icing pad	48
—	Environmental considerations	49
4.	OBSTACLE RESTRICTION AND REMOVAL	50
4.1	Limitation surface.....	50
—	Conical surface.....	50
—	Inner horizontal surface	50
	Outer horizontal surface	50
—	Approach surface	51
—	Inner Approach surface.....	51
—	Transitional side surface	51
—	Inner transitional surface	52
—	Balked landing surface	52
—	Take-off climb surface	59
4.2	Obstacle limitation requirements	60
—	Approach runways	60
—	Take-off runways	62

4.3	Other objects	65
4.4	Shielding.....	65
5.	VISUAL AIDS FOR NAVIGATION.....	66
5.1	Indicators	66
—	Wind direction indicators	66
5.2	Markings	66
—	General	66
—	Interruption of runway markings	67
—	Colour	67
—	Unpaved taxiways	68
—	Runway designation marking.....	68
—	Runway centre line marking	70
—	Threshold marking	71
—	Aiming point marking	72
—	Touchdown zone marking	74
—	Runway touchdown zone limit marking	76
—	Runway side stripe marking.....	76
—	Taxiway centre line marking	77
—	Runway turn pad marking	79
—	Runway-holding position marking	80
—	Intermediate holding position marking	81
—	Taxiway designation marking.....	81
—	VOR aerodrome check-point marking.....	82
—	Aircraft stand markings.....	82
—	Lead in lead out lines	83
—	Aircraft stand identification	83
—	Turn bar	84
—	Alignment bar	85
—	Stop line	85
—	Nose wheel stop block	85
—	Equipment clearance lines	85
—	Equipment parking areas	86
—	Jet Wash and Propeller Wash	86
—	No parking areas	87
—	Passenger walkway lines	87
—	Road-holding position marking	88
—	Mandatory instruction marking	88
—	Information marking.....	89
—	Runway ahead	90
—	Demarcation line separating manoeuvring area and apron.....	90
—	Painting specification	91
5.3	Lights	92
—	Lights which may endanger the safety of aircraft.....	92
—	Lights which may cause confusion.....	92
—	Elevated approach lights	92
—	Elevated lights	92
—	Surface lights	92
—	Light intensity and control.....	93
—	Aerodrome beacon.....	93
—	Identification beacon	94
—	Approach lighting systems.....	94
—	Low intensity approach lighting system 1 red bar	94
—	Low intensity approach lighting system 2 red bar	96
—	High intensity approach lighting system (Cat I)	99
—	High intensity approach lighting system (category II or III).....	100
—	Visual approach slope indicator systems.....	103
—	VASIS and AVASIS	105
—	T-VASIS and AT-VASIS	108
—	PAPI and APAPI	111
—	Obstacle protection surface	116
—	Wind direction indicators	117
—	Circling guidance lights	118
—	Runway lead-in light system	119

—	Runway threshold identification lights.....	119
—	Runway edge lights	120
—	Runway threshold and wing bar lights	121
—	Runway end lights	122
—	Runway centre line lights	122
—	Runway touchdown zone lights	123
—	Runway touchdown zone limit lights	124
—	Stopway lights	124
—	Starter extension edge lights	124
—	Starter extension end lights.....	125
—	Taxiway centre line lights	125
—	Taxiway edge lighting	126
—	Runway turn pad lights	127
—	Stop bars	127
—	Intermediate holding position lights.....	128
—	De-icing/anti-icing facility exit lights	128
—	Runway guard lights	129
—	Apron floodlighting	130
—	Visual docking guidance system.....	132
—	Azimuth guidance unit.....	133
—	Stopping position indicator	133
—	Aircraft stand manoeuvring guidance lights	134
—	Operational lighting controls	134
—	Portable or temporary runway, taxiway or apron edge lighting.....	135
—	Road-holding position light	136
5.4	Signs	136
—	General	136
—	Lighting	138
—	Mandatory instruction signs	138
—	Information signs	141
—	VOR aerodrome check-point sign.....	146
—	Aerodrome identification sign	147
—	Aircraft stand identification signs.....	147
—	Road-holding position sign	148
5.5	Markers.....	148
—	General	148
—	Unpaved runway edge markers	148
—	Stopway edge markers.....	149
—	Edge markers for snow covered runways.....	149
—	Taxiway edge markers	149
—	Taxiway centre line markers.....	149
—	Unpaved taxiway edge markers	150
—	Boundary marking.....	150
6.	VISUAL AIDS FOR DENOTING OBSTACLES	152
6.1	Objects to be marked or lighted	152
6.2	Marking of objects.....	153
—	General	153
—	Use of colours.....	153
—	Use of markers.....	155
—	Use of flags.....	155
6.3	Lighting of objects	156
—	Use of obstacle lights.....	156
—	Location of obstacle lights.....	157
—	Low-intensity obstacle light.....	160
—	Medium-intensity obstacle lights	161
—	High-intensity obstacle lights.....	162
7.	VISUAL AIDS FOR DENOTING RESTRICTED USE AREAS.....	164
7.1	Closed runways and taxiways, or parts thereof.....	164
—	Application	164
—	Location	164
—	Characteristics	164
7.2	Non load-bearing surfaces.....	164
—	Application	164

—	Location	165
—	Characteristics	165
7.3	Pre-threshold area	165
—	Application	165
—	Location	165
—	Characteristics	165
7.4	Unserviceable areas	166
8.	EQUIPMENT AND INSTALLATIONS	169
8.1	Secondary power supply	169
—	General	169
—	Visual Aids	170
8.2	Circuit design	170
8.3	Monitoring	170
8.4	Siting and construction of equipment and installations on operational areas	171
8.5	Surface movement guidance and control systems	171
8.6	Visual aids	172
APPENDICES		176
Appendix 1	Colours for aeronautical ground lights, markings, signs and panels	177
1.	General	177
2.	Colours for aeronautical ground lights	177
3.	Colours for markings, signs and panels	179
Appendix 2	Aeronautical ground light characteristics	187
Appendix 3	Mandatory instruction markings and information markings	213
Appendix 4	Requirements concerning design of taxiing signs	219
Appendix 5	Aeroplane characteristics	229

1. GENERAL

1.1 Introduction

In accordance with the requirements of rules 139.51(a), 121.71(a)(1), 125.77(a)(1), and 135.77(a)(1), the physical characteristics of an aerodrome that is either certificated under Part 139, or used for air operations under Parts 121, 125, or 135, the obstacle limitation surfaces, the visual aids for navigation and for denoting obstacles and restricted areas, and the equipment and installations for the aerodrome must be commensurate with—

- (a) the characteristics of the aircraft that the aerodrome is intended to serve
- (b) the lowest meteorological minima intended for each runway, and
- (c) the ambient light conditions intended for aircraft operations.

Under rule 139.51(c), the runway safety end area (RESA) must be acceptable to the Director.

Under rule 139.51(d), the physical characteristics, obstacle limitation surfaces, visual aids, equipment and installations, provided at the aerodrome must comply with the applicable appendices to Part 139.

In line with the applicable standards of ICAO Annex 14, this AC provides guidance for compliance with the requirements of Parts 139, 121, 125, and 135.

1.2 Applicability

Rule 139.51 applies to all aerodromes that are certificated under Part 139 and those aerodromes used by aeroplanes operating under Parts 121, 125 and 135. This AC should be read in its entirety to determine the design required at the aerodromes.

1.3 Definitions

See also Part 1 of the Civil Aviation Rules for other terms.

Advanced Surface Movement Guidance & Control System (A-SMGCS) is a system providing routing, guidance and surveillance for the control of aircraft and vehicles in order to maintain the declared surface movement rate under all weather conditions within the aerodrome visibility operational level (AVOL) while maintaining the required level of safety.

Aerodrome beacon means an aeronautical beacon used to indicate the location of an aerodrome from the air.

Aerodrome elevation means the elevation of the highest point of the landing area in terms of height above mean sea level.

Aerodrome protection surfaces means defined areas about and above an aerodrome intended for the protection of aircraft in the vicinity of an aerodrome.

Aerodrome reference point means the designated geographical location of an aerodrome.

Aerodrome traffic density

- (a) Light. Where the number of movements in the mean busy hour is not greater than 15 per runway or typically less than 20 total aerodrome movements.

(b) Medium. Where the number of movements in the mean busy hour is of the order of 16 to 25 per runway or typically between 20 to 35 total aerodrome movements.

(c) Heavy. Where the number of movements in the mean busy hour is of the order of 26 or more per runway or typically more than 35 total aerodrome movements.

Note 1: The number of movements in the mean busy hour is the arithmetic mean over the year of the number of movements in the daily busiest hour.

Note 2: Either a take-off or a landing constitutes a movement.

Aeronautical beacon means an aeronautical ground light visible at all azimuths, either continuously or intermittently, to designate a particular point on the surface of the earth.

Aeronautical ground light means any light specially provided as an aid to air navigation, other than a light displayed on an aircraft.

Aeronautical study means a study conducted by, or for, the Director.

Aeroplane reference field length means the minimum field length required for take-off at maximum certificated take-off mass, sea level, standard atmospheric conditions, still air and zero runway slope.

Aircraft classification number (ACN) means a number expressing the relative effect of an aircraft on a pavement for a specified standard sub grade category.

Note: The aircraft classification number is calculated with respect to the centre of gravity (CG) position which yields the critical loading on the critical gear. Normally the aft-most CG position appropriate to the maximum gross apron (ramp) mass is used to calculate the ACN. In exceptional cases the forward most CG position may result in the nose gear loading being more critical.

Aircraft stand means a designated area on an apron intended to be used for parking an aircraft.

Air traffic service includes:

- (a) any aerodrome control service
- (b) any area control service
- (c) any approach control service
- (d) any flight information service
- (e) any aerodrome flight information service
- (f) any alerting service, or
- (g) any other air traffic service considered by the Director to be necessary or desirable for the safe and efficient operation of the civil aviation system.

Approach area means a specific portion of the surface of the ground or water immediately in front of a landing threshold. It is an area within which it may be necessary to take one or more of the following actions in order to ensure a satisfactory level of safety and regularity for aircraft operation during the approach phase:

- (a) restrict the creation of new obstacle, or
- (b) remove or mark existing obstacles.

Approach surface means a specified portion of an inclined plane or a combination of planes limited in plan by the vertical projection of the approach area.

Barrette means three or more aeronautical ground lights closely spaced in a transverse line so that from a distance they appear as a short bar of light.

Capacitor discharge light means a lamp in which high intensity flashes of extremely short duration are produced by the discharge of electricity at high voltage through a gas enclosed in a tube.

Coded means an established routine in a line of lights which indicates the position in the line by means of colour, light intensity or pattern.

Conical surface means a specified surface sloping upwards and outwards from the periphery of the inner horizontal surface. It establishes the vertical limits above which it may be necessary to restrict the creation of new obstacles, or remove or mark existing obstacles, to ensure the safety of aircraft manoeuvring by visual reference in the aerodrome circuit prior to landing.

Cross wind component means the velocity component of the wind at or corrected to a height of 10m above aerodrome elevation, at right angles to the direction of take-off or landing.

De-icing/anti-icing facility means a facility where frost, ice or snow is removed (de-icing) from the aeroplane to provide clean surfaces, and/or where clean surfaces of the aeroplane receive protection (anti-icing) against the formulation of frost or ice and accumulation of snow or slush for a limited period of time.

De-icing/anti icing pad means an area comprising an inner area for the parking of an aeroplane to receive de-icing/anti-icing treatment and an outer area for the manoeuvring of two or more mobile de-icing/anti-icing equipment.

Dependent parallel operations means simultaneous approaches to parallel or near parallel instrument runways where radar separation minima between aircraft on adjacent extended runway centre lines are prescribed.

Displaced threshold means a threshold not located at the extremity of a runway.

Effective intensity means the effective intensity of a flashing light is equal to the intensity of a fixed light of the same colour which will produce the same visual range under identical conditions of observation.

Fixed light means a light having a constant luminous intensity when observed from a fixed point.

Frangibility means a characteristic of an object to retain its structural integrity and stiffness up to a desired maximum load, but on impact from a greater load, to break, distort or yield in such a manner as to present the minimum hazard to aircraft.

Gradient means the ratio of height change over distance travelled expressed in common units.

Hazard beacon means an aeronautical beacon used to designate a danger to aircraft.

Holding bay means a defined area where aircraft can be held, or bypassed, to facilitate efficient surface movement of aircraft.

Identification beacon means an aeronautical beacon emitting a coded signal by means of which a particular point of reference can be identified.

Independent parallel approaches means simultaneous approaches to parallel or near parallel instrument runways where radar separation minima between aircraft on adjacent extended runway centre lines are not prescribed.

Independent parallel departures means simultaneous departures from parallel or near parallel instrument runways.

Inner horizontal surface means a specified portion of a horizontal plane located above an aerodrome and its immediate environment. This surface establishes the height above which it may be necessary to restrict the creation of new obstacles, or remove or mark existing obstacles, to ensure the safety of aircraft manoeuvring by visual reference in the aerodrome circuit prior to landing.

Instrument approach operation Type A means an instrument approach procedure with a minimum descent height or decision height at or above 75m (250ft).

Instrument approach operation Type B means an instrument approach procedure with a decision height below 75m (250ft).

Instrument runway means one of the following types of runways intended for the operation of aircraft using instrument approach procedures:

- (a) Non precision approach runway. An instrument runway served by visual aids and a non-visual aid(s) intended for landing operations following an instrument approach operation type A and a visibility not less than 1000m.
- (b) Precision approach runway, Category I : A runway served by visual aids and non-visual aid(s) intended for landing operations following an instrument approach operation type B with a decision height (DH) not lower than 60 m (200 ft) and either a visibility not less than 800 m or a runway visual range not less than 550 m.
- (c) Precision approach runway, Category II. A runway served by visual aids and non-visual aid(s) intended for landing operations following an instrument approach operation type B with a decision height (DH) lower than 60 m (200 ft) but not lower than 30 m (100 ft) and a runway visual range not less than 300 m.
- (d) Precision approach runway, Category III. A runway served by visual aids and non-visual aid(s) intended for landing operations following an instrument approach operation type B to and along the surface of the runway and:
 - (i) Category IIIA: intended for operations with a decision height (DH) lower than 30 m (100 ft), or no decision height and a runway visual range not less than 175 m.
 - (ii) Category IIIB: intended for operations with a decision height (DH) lower than 15 m (50 ft), or no decision height and a runway visual range less than 175 m but not less than 50 m.
 - (iii) Category IIIC: intended for operations with no decision height (DH) and no runway visual range limitations.

Intermediate holding position means a designated position intended for traffic control at which taxiing aircraft and vehicles should stop and hold until further cleared to proceed, when so instructed by the aerodrome control tower.

Landing area means that part of a movement area intended for the landing or take off of aircraft.

Light failure means a light should be considered to have failed when for any reason the average intensity determined using the specified angles of beam elevation, toe in and spread falls below 50% of the specified average intensity of a new light.

Lighting system reliability means the probability that the complete installation operates within the specified tolerances and that the system is operationally useable.

Manoeuvring area means—

(a) that part of an aerodrome to be used for the take-off and landing of aircraft and for the surface movement of aircraft associated with take-off and landing; but

(b) does not include areas set aside for loading, unloading or maintenance of aircraft.

Marker means an object displayed above ground level in order to indicate an obstacle or delineate a boundary.

Marking means a symbol or group of symbols displayed on the surface of the movement area in order to convey aeronautical information.

Movement area means that part of an aerodrome intended to be used for the take-off and landing of aircraft and for the surface movement of aircraft, and includes the manoeuvring area and the aprons.

Near parallel runways means non intersecting runways whose extended centre lines have an angle of convergence divergence of 15° or less.

Non instrument runway means a runway intended for the operation of aircraft using visual approach procedures.

Obstacle means all fixed (whether temporary or permanent) and mobile objects, or parts thereof, that are located on an area intended for the surface movement of aircraft or that extend above a defined surface intended to protect aircraft in flight.

Obstacle free zone (OFZ) means the airspace above the inner approach surface, inner transitional surfaces, and balked landing surface and that portion of the strip bounded by these surfaces, which is not penetrated by any fixed obstacle other than a low-mass and frangible mounted one required for air navigation purposes.

Obstacle limitation surfaces means defined areas about and above an aerodrome intended for the protection of aircraft in the vicinity of an aerodrome.

Outer horizontal surface means a specified portion of a horizontal plane located above the environment of an aerodrome beyond the horizontal limits of the conical surface.

Outer main gear wheel span means the distance between the outside edges of the main gear wheels.

Pavement classification number (PCN) means a number expressing the bearing strength of a pavement for unrestricted operations.

Portal beacons means two ground light fixtures in an Aerodrome Lead In Lighting System, forming a gateway for approaching or departing aircraft.

Primary runway(s) means runway(s) used in preference to others whenever conditions permit.

Road means an established surface route on the movement area meant for the exclusive use of vehicles.

Road-holding position means a designated position at which vehicles may be required to hold.

Runway guard lights means a light system intended to caution pilots or vehicle drivers that they are about to enter an active runway.

Runway-holding position means a designated position intended to protect a runway, an obstacle limitation surface, or an ILS/ MLS critical/sensitive area at which taxiing aircraft and vehicles should stop and hold, unless otherwise authorized by the aerodrome control tower.

Runway starter extension means an additional runway length made available for take-off, prior to the normal runway end at the commencement of the take-off run.

Segregated parallel operations means simultaneous operations on parallel or near-parallel instrument runways in which one runway is used exclusively for approaches and the other runway is used exclusively for departures.

Sign means either a—

- (a) Fixed message sign. A sign presenting only one message, or
- (b) Variable message sign. A sign capable of presenting several pre-determined messages or no message, as applicable.

Shoulder means an area adjacent to the edge of a pavement so prepared as to provide a transition between the pavement and the adjacent surface.

Switch-over time (light) means the time required for the actual intensity of a light measured in a given direction to fall from 50% and recover to 50% during a power supply changeover, when the light is being operated at intensities of 25% or above.

Take-off climb area means a specified area of ground (or water) beyond the end of a runway, strip or clearway, within which it may be necessary to restrict the creation of new obstructions or remove or mark objects which could affect the safety of aircraft taking off.

Take-off climb surface means a specified portion of an inclined plane or other specified surface limited in plan by the vertical projection of the take-off climb area.

Taxi holding position means a designated position at which taxiing aircraft and vehicles may be required to hold in order to provide adequate clearance from a runway.

Taxiway means a defined path on a land aerodrome established for the taxiing of aircraft and intended to provide a link between one part of the aerodrome and another. It includes the following.

- (a) Aircraft stand taxi lane: A portion of an apron designated as a taxiway and intended to provide access to aircraft stands only.
- (b) Apron taxiway: A portion of the taxiway system located on an apron and intended to provide a through taxi route across the apron.
- (c) Rapid-exit taxiway: A taxiway connected to a runway at an acute angle and designed to allow landing aeroplanes to turn off at higher speeds than are achieved on other exit taxiways thereby minimising runway occupancy times.

Taxiway intersection means a junction of two or more taxiways.

Taxiway strip means an area including a taxiway intended to protect an aircraft operating on the taxiway and to reduce the risk of damage to an aircraft accidentally running off the taxiway.

Threshold means the beginning of that portion of the runway useable for landing.

Touchdown zone means the portion of the runway, beyond the threshold, where it is intended landing aeroplanes first contact the runway.

Transitional side surface means a specified surface sloping upwards and outwards from the side of the strip, and the approach surface to the inner horizontal surface or to a specified height. The transitional surface establishes the heights above which it may be necessary to restrict the creation of new obstacles, or remove or mark existing obstacles, to ensure a satisfactory level of safety and regularity for aircraft flying at low altitude and displaced from the runway centre line in the approach or missed approach phases.

Usability factor means the percentage of time during which the use of a runway or system of runways is not restricted because of the cross-wind component.

Wheel base means the distance from the nose gear of an aircraft to the geometric centre of the main gear.

1.4 Reference code

The rule requirements to determine a reference code are covered in Part 139, Appendix B.

1.4.1 The intent of the reference code is to provide a simple method for inter-relating the numerous specifications concerning the characteristics of aerodromes so as to provide a series of aerodrome facilities that are suitable for the aeroplanes that are intended to operate at the aerodrome. **The code is not intended to be used for determining runway length or pavement strength requirements.**

1.4.2 The code is composed of two elements which are related to the aeroplane performance characteristics and dimensions. **Element 1** is a number based on the aeroplane reference field length and **Element 2** is a letter based on the aeroplane wing span and the outer main gear wheel span. A particular specification is related to the more appropriate of the two elements of the code or to an appropriate combination of the two code elements. The code letter or number within an element selected for design purposes is related to the critical characteristics for which the facility is provided. When applying Part 139, Appendix B, Table B-1, the aeroplanes for which the aerodrome is intended to serve are first identified and then the two elements of the code.

1.4.3 The CAA has established some minimum requirements for existing aerodromes where it is intended to operate the A380-800 aircraft but the aerodrome does not fully comply with the applicable Code F requirements. This document, "Interim Aerodrome Requirements for the A380", is available from the CAA website at www.caa.govt.nz/aerodromes/A380paper.pdf and should be read in conjunction with this AC.

A list of representative aeroplanes operating in New Zealand, chosen to provide an example of each possible aerodrome reference code number and letter combination, is shown in Appendix 5 of this AC.

1.5 Summary of aerodrome requirements

1.5.1 Each runway should be served by obstacle limitation surfaces, and surrounded by an obstacle free strip. The aerodrome as a whole should be surrounded by an obstacle free circuiting area.

1.5.2 Their method of application is amplified in section 4. Tables 4-1 and 4-2 summarise the gradients and minimum dimensions of surfaces. These criteria are not intended to set operational limitations, but set the minimum standards for aerodrome design.

2. AERODROME DATA

This section contains specifications relating to the provision of data about aerodromes to be notified to the Aeronautical Information Service (AIS). Geographical coordinates indicating latitude and longitude should be determined and reported in terms of the World Geodetic System – 1984 (WGS-84) geodetic reference datum.

2.1 Aerodrome reference point

2.1.1 An aerodrome reference point should be established for an aerodrome.

2.1.2 The aerodrome reference point is to be located near the initial or planned geometric centre point of the aerodrome and should normally remain where first established.

2.1.3 The position of the aerodrome reference point is to be surveyed and given to the nearest second of latitude and longitude.

2.2 Aerodrome and runway elevations

2.2.1 The aerodrome elevation is to be measured and given to the nearest foot.

2.2.2 For an aerodrome used by international civil aviation, the elevation of each threshold, the elevation of the runway end and any significant high and low points along the runway, and the highest elevation of the touchdown zone of a precision approach runway is to be given to the nearest foot.

2.3 Aerodrome reference temperature

2.3.1 An aerodrome reference temperature is to be determined for the aerodrome in degrees celsius.

2.3.2 The aerodrome reference temperature is to be the monthly mean of the daily maximum temperatures for the hottest month of the year (the hottest month being that which has the highest monthly mean temperature). This temperature is to be averaged over a period of years.

2.4 Aerodrome dimensions and related information

2.4.1 The following data should be surveyed or described, as appropriate, for each facility provided on an aerodrome—

- (a) runway — true bearing to one-hundredth of a degree, designation number, length, width, displaced threshold location to the nearest metre or foot, slope, surface type, type of runway and, for a precision approach runway category I, the existence of an obstacle free zone when provided
- (b) strip, runway end safety area and stopway — length, width to the nearest metre or foot and surface type
- (c) taxiway — designation, width, surface type
- (d) apron — surface type, aircraft stands
- (e) clearway — length to the nearest metre or foot, ground profile
- (f) significant obstacles on and in the vicinity of the aerodrome — location, top elevation to the nearest (next higher) metre or foot, type

- (g) visual aids for the approach procedures, marking and lighting of runways, taxiways and aprons, other visual guidance and control aids on taxiways and aprons, including taxi-holding positions and stopbars, and location and type of visual docking guidance systems
- (h) location and radio frequency of any VOR aerodrome check-point
- (i) location and designation of standard taxi-routes
- (j) distances to the nearest metre or foot of localizer and glide path elements comprising an instrument landing system (ILS) or azimuth and elevation antenna of microwave landing system (MLS) in relation to the associated runway extremities.

2.4.2 The geographical coordinates of each threshold is to be measured and given to the nearest second.

2.4.3 The geographical coordinates of each aircraft stand is to be measured and given to at least one-tenth of a minute.

This information may be best shown in the form of a chart.

2.5 Strength of pavement

2.5.1 The bearing strength of a pavement is to be determined.

2.5.2 The bearing strength of a pavement intended for aircraft of apron (ramp) mass greater than 5700kg is to be made available using the aircraft classification number - pavement classification number (ACN-PCN) method by reporting all of the following information—

- (a) the pavement classification number (PCN)
- (b) pavement type for ACN-PCN determination
- (c) subgrade strength category
- (d) maximum allowable tire pressure category or maximum allowable tire pressure value
- (e) evaluation method.

If necessary, PCN may be published to an accuracy of one-tenth of a whole number.

2.5.3 The pavement classification number (PCN) reported should indicate that an aircraft with an aircraft classification number (ACN) equal to or less than the reported PCN can operate on the pavement subject to any limitation on tyre pressure, or aircraft all-up mass for the specified aircraft type(s).

Different PCN may be reported if the strength of the pavement is subject to significant seasonal variation.

2.5.4 The ACN of an aircraft should be determined in accordance with the standard procedures associated with the ACN-PCN method.

The standard procedures for determining the ACN of an aircraft are given in the - Aerodrome Design Manual (ICAO Doc 9157), Part 3. For convenience several aircraft types currently in use have been evaluated on rigid and flexible pavements founded on the four subgrade categories 2.5.6 below and the results tabulated in that manual.

2.5.5 For the purposes of determining the ACN, the behaviour of a pavement should be classified as equivalent to a rigid or flexible construction.

2.5.6 Information on pavement type for ACN-PCN determination, subgrade strength category, maximum allowable tire pressure category and evaluation method should be reported using the following codes:

Pavement type for ACN-PCN determination	
Pavement type	Code
Rigid pavement	R
Flexible pavement	F

If the actual construction is composite or non-standard, include a note to that effect (see example 2 below).

Subgrade strength category	
	Code
<p>High strength:</p> <p><i>Characterised by $K=150 \text{ mN/m}^3$ and representing all K values above 120 mN/m^3 for rigid pavements, and by $CAR=15$ and representing all CAR values above 13 for flexible pavements.</i></p>	A
<p>Medium strength:</p> <p><i>Characterised by $K=80 \text{ mN/m}^3$ and representing a range in K of 60 to 120 mN/m^3 for rigid pavements, and by $CBR=10$ and representing a range in CBR of 8 to 13 for flexible pavements</i></p>	B
<p>Low strength:</p> <p><i>Characterised by $K=40 \text{ mN/m}^3$ and representing a range in K of 25 to 60 mN/m^3 for rigid pavements, and by $CBR=6$ and representing a range in CBR of 4 to 8 for flexible pavements</i></p>	C
<p>Ultra low strength:</p> <p><i>Characterised by $K=20 \text{ mN/m}^3$ and representing all K values below 25 mN/m^3 for rigid pavements, and by $CBR=3$ and representing all CBR values below 4 for flexible pavements.</i></p>	D

Maximum allowable tire pressure category	
Tire pressure category	Code
Unlimited: no pressure limit	W
High: pressure limited to 1.75mPa	X
Medium: pressure limited to 1.25mPa	Y
Low: pressure limited to 0.50 mPa	Z
High: no pressure limit	W
Medium: pressure limited to 1.50 mPa	X
Low: pressure limited to 1.00 mPa	Y
Very low: pressure limited to 0.50 mPa	Z

Evaluation method	
	Code
Technical method <i>Representing a specific study of the pavement characteristics and application of pavement behaviour technology.</i>	T
Using aircraft experience <i>Representing a knowledge of the specific type and mass of aircraft satisfactorily being supported under regular use.</i>	U

The following examples illustrate how pavement strength data are reported under the ACN-PCN method.

Example 1: If the bearing strength of a rigid pavement, resting on a medium strength subgrade, has been assessed by technical evaluation to be PCN 80 and there is no tyre pressure limitation, then the reported information would be:

PCN 80/R/B/W/T

Example 2: If the bearing strength of a composite pavement, behaving like a flexible pavement and resting on a high strength subgrade, has been assessed by using aircraft experience to be PCN 50 and the maximum tire pressure allowable is 1.00 mPa, then the reported information would be:

PCN 50/F/A/Y/U

Note: Composite construction.

Example 3: If the bearing strength of a flexible pavement, resting on a medium strength subgrade, has been assessed by technical evaluation to be PCN 40 and the maximum allowable tire pressure is 0.80 mPa, then the reported information would be:

PCN 40/F/B/0.80 mPa/T

Example 4: If a pavement is subject to a B747-400 all-up mass limitation of 390,000 kg, then the reported information would include the following note.

Note: The reported PCN is subject to a B747-400 all-up mass limitation of 390,000 kg.

2.5.7 Criteria should be established to regulate the use of a pavement by an aircraft with an ACN higher than the PCN reported for that runway in accordance with 2.5.2 and 2.5.3.

2.5.8 The bearing strength of a pavement intended for aircraft of apron (ramp) mass equal to or less than 5700 kg should be made available by reporting the following information:

- (a) maximum allowable aircraft mass; and
- (b) maximum allowable tire pressure.

Example — 4000 kg/0.5 mPa.

2.6 Pre-flight altimeter check location

2.6.1 One or more pre-flight check locations should be established for an aerodrome.

2.6.2 A pre-flight check location should be located on the apron.

Locating the pre-flight check location on the apron enables an altimeter check to be made prior to obtaining taxi clearance and eliminates the need for stopping for that purpose after leaving the apron.

Normally the entire apron can serve as a satisfactory altimeter check location.

2.6.3 The elevation of a pre-flight altimeter check location is to be given as the average elevation, rounded to the nearest foot, of the area on which it is located. The elevation of any portion of a pre-flight altimeter check location should be within 10 feet of the average elevation for that location.

2.7 Declared distance

2.7.1 The following distances should be calculated for each runway:

- (a) take-off run available
- (b) take-off distance available
- (c) accelerate-stop distance available
- (d) landing distance available.

2.7.2 The declared distances to be calculated for each runway direction comprise: the take-off run available (TORA), take-off distance available (TODA), accelerate-stop distance available (ASDA), and landing distance available (LDA).

2.7.3 Where a runway is not provided with a stopway or clearway and the threshold is located at the beginning of the runway, the four declared distances should normally be equal to the length of the runway, as shown in Figure 2-1 diagram A.

2.7.4 Where a runway is provided with a clearway, then the TODA will include the length of clearway, as shown in Figure 2-1 diagram B.

2.7.5 Where a runway is provided with a stopway, then the ASDA will include the length of stopway, as shown in Figure 2-1 diagram C.

2.7.6 Where a runway has a displaced threshold, then the LDA will be reduced by the distance the threshold is displaced, as shown in Figure 2-1 diagram A. A displaced threshold affects only the LDA for approaches made to that threshold; declared distances for operations in the reciprocal direction may or may not be affected depending on the cause of the displacement.

2.7.7 Figure 2-1 diagram B through diagram D illustrate a runway provided with a clearway or a stopway or having a displaced threshold. Where more than one of these features exist, then more than one of the declared distances will be modified — but the modification will follow the same principle illustrated. An example showing a situation where all these features exist is shown in Figure 2-1 diagram E.

2.7.8 A suggested format for providing information on declared distances is given in Figure 2-1 diagram F. If a runway direction cannot be used for take-off or landing, or both, because it is operationally forbidden, then this should be declared and the words *not useable* or the abbreviation NU entered.

2.8 Disabled aircraft removal

2.8.1 Information concerning the capability to remove an aircraft disabled on or adjacent to the movement area should be made available.

The capability to remove a disabled aircraft may be expressed in terms of the largest type of aircraft which the aerodrome is equipped to remove.

2.8.2 Contact details including the telephone number(s) of the office of the aerodrome co-ordinator of operations for the removal of an aircraft disabled on or adjacent to the movement area should be made available, on request, to aircraft operators.

2.9 Rescue and firefighting

2.9.1 Information on the level of protection provided at an aerodrome for aircraft rescue and firefighting purposes should be made available.

2.9.2 The level of protection normally available is to be expressed in terms of the category of the rescue and firefighting services in accordance with rule 139.59.

2.9.3 Significant changes in the level of protection normally available at an aerodrome for rescue and firefighting should be notified to the AIS to provide the necessary information to arriving and departing aircraft. When such a change has been corrected, the AIS should be advised accordingly.

significant change in the level of protection is considered to be a change in category of the rescue and firefighting service from the category normally available at the aerodrome, resulting from a change in availability of extinguishing agents, equipment to deliver the agents or personnel to operate the equipment, and so on.

2.9.4 A significant change is to be expressed in terms of the new category of the rescue and firefighting service available at the aerodrome.

2.10 Visual approach slope indication system

The following information concerning a visual approach slope indicator system installation should be made available.

- (a) Associated runway designation number.
- (b) Type of system according to paragraph 5.3.50. For an AVASIS installation, the number of light units should be given and additionally for an asymmetrical AVASIS installation, and for an AT-VASIS, PAPI or APAPI installation, the side of the runway on which the lights are installed, left or right, should be given.
- (c) Where the axis of the system is not parallel to the runway centre line, the angle of displacement and the direction of displacement, left or right, should be indicated.
- (d) Nominal approach slope angle(s). For a VASIS or an AVASIS this should be angle $(A+D)/2$ according to the formula in Figure 5-17. For a T-VASIS or an AT-VASIS this should be angled according to Figure 5-20 and for a PAPI and an APAPI this should be the angle $(B+C)/2$ and $(A+B)/2$, respectively as in Figure 5-23.
- (e) Minimum eye height(s) over the threshold of the on slope signal(s). For a VASIS or an AVASIS this height should be the top of the red signal from the downwind wing bar(s), that is, angle B. For a T-VASIS or an AT-VASIS this should be the lowest height at which only the wing bar(s) are visible; however, the additional heights at which the wing bar(s) plus one, two or three fly down light units come into view may also be reported if such information would be of benefit to aircraft using the approach. For a PAPI this should be the setting angle of the third unit from the runway minus 2 minutes, that is angle B minus 2 minutes, and for an APAPI this should be the setting angle of the unit farther from the runway minus 2 minutes, that is angle A minus 2 minutes.

When computing (d) or (e) for slotted-type VASIS or AVASIS, attention is drawn to the one eighth of a degree difference between the angles as seen in space and the setting angles seen on the ground.

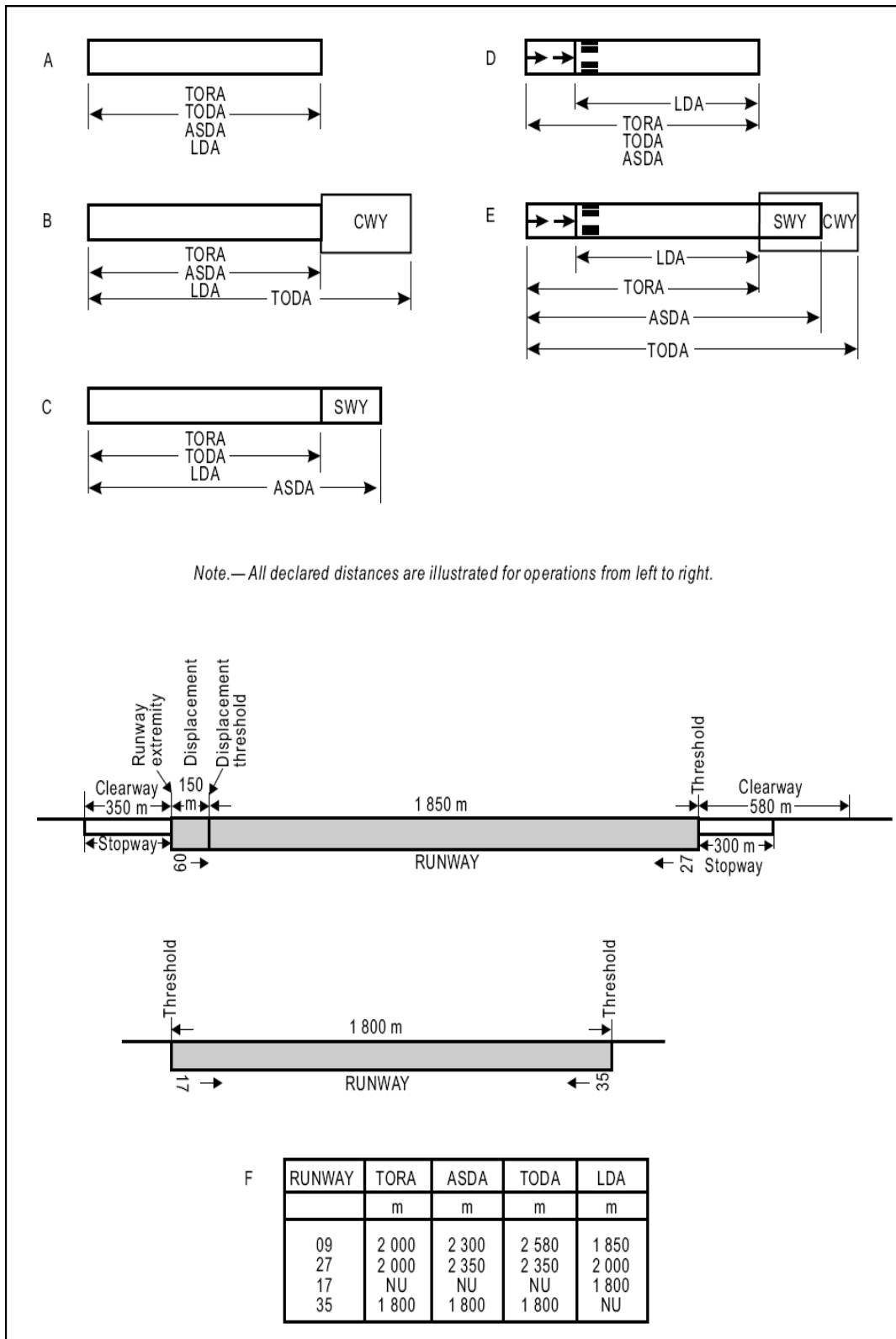

Figure 2-1: Illustration of declared distances

3. PHYSICAL CHARACTERISTICS

3.1 Runways

— Orientation and number

Many factors affect the determination of the orientation, siting and number of runways and strips. One important factor is the usability factor, as determined by the wind distribution, which is specified below. Another important factor is the alignment of runway to facilitate the provision of the related approach and take-off surfaces, as described in more detail in section 4.

When a new instrument runway is being located, particular attention needs to be given to areas over which aeroplanes will be required to fly when following instrument approach and missed approach procedures, to ensure that obstacles in these areas or other factors will not restrict the operation of the aeroplanes for which the runway is intended.

3.1.1 The number and orientation of runways at an aerodrome should be such that the usability factor of an aerodrome is not less than 95% for the aeroplanes that the aerodrome is intended to serve.

— Cross-wind factor

3.1.2 This is the component of wind acting at right angles to the runway. The alignment of a runway should be such that, taking into account the type of aircraft envisaged, the disruption due to cross-wind will be at a minimum. The following cross-wind components are to be used in determining the usability factor of a runway.

- 37 km/hr (20 kt) in the case of aeroplanes whose reference field length is 1500 m or over. When poor runway braking action owing to insufficient longitudinal coefficient of friction is experienced with some frequency, a cross-wind component not exceeding 24 km/hr (13 kt) should be assumed.
- 24 km/hr (13 kt) in the case of aeroplanes whose reference field length is 1200 m or up to but not including 1500 m
- 19 km/hr (10 kt) in the case of aeroplanes whose reference field length is less than 1200 m.

3.1.3 The cross-wind components specified above refer to the mean at any time and not to peak value of gusts. The figures also relate primarily to operations on dry runways. In certain circumstances, having regard to the type of aircraft and services envisaged, the wet surface operational limitations of lesser cross-wind values applicable to the aircraft may require to be applied.

The selection of data to be used for the calculation of the usability factor should be based on reliable wind distribution statistics that extend over as long a period as possible, preferably of not less than 5 years. The observations used should be made at least eight times daily and spaced at equal intervals of time.

— Location of threshold

3.1.4 The design threshold of a runway should be located at a distance of 60 m (30 m for a Code 1 runway) from the point of intersection of the surface with the sloping approach plane over the critical obstacle within the approach fan.

— **Displaced threshold**

3.1.5 When the mandatory gradient rising from the threshold of the runway (or the strip if there is no runway) is infringed by an obstacle, a displaced threshold is to be marked at the location where the mandatory gradient just clearing the obstacle intersects the runway.

Displacement of the landing threshold for code number 3 and 4 runways is not normally practicable except for emergency reasons, when operational minima will also be affected. Should such a displacement be necessary special consideration must be given to the clearances and the approach or landing aids necessary for continued operations by large jet aircraft.

— **Actual length of runways**

Primary runway

3.1.6 Except as provided in paragraph 3.1.8, the actual length to be provided for a primary runway should be adequate to meet the operational requirements of the aeroplanes for which the runway is intended and should be not less than the longest length determined by applying the corrections for local conditions to the operations and performance characteristics of the relevant aeroplanes.

The length of a runway is derived from the operational characteristics of the type of aircraft intended to use the runway.

The distances required by a particular aeroplane under various operating conditions are determined from its flight manual or performance schedule. They depend on the actual weight of the aeroplane; the aerodrome elevation; the longitudinal runway slope, surface and condition; the wind component and the air temperature. It should not always be necessary to provide for take-offs and landings at the maximum certified weight of the most exacting aircraft but enough length should be provided to ensure an economic take-off weight related to the routes to be flown from the aerodrome.

Secondary runway

3.1.7 If more than one runway is needed to provide the required usability, the subsidiary runways should be at least 85% of the length of the main runway. The factor of 85% is intended to allow for the headwind component which will normally be present when the subsidiary runway is required to be used due to the cross-wind on the main runway.

Sometimes the largest aircraft likely to use an aerodrome will not need a subsidiary runway and therefore the length of the subsidiary runway need only be related to the smaller aircraft which are expected to use it and the factor of 85% is then applied to the length required by those aircraft in still air.

Runways with stopways or clearways

3.1.8 Where a runway is associated with a stopway or clearway, an actual runway length less than that resulting from application of paragraph 3.1.6 or paragraph 3.1.7, as appropriate, may be considered satisfactory, but in such a case any combination of runway, stopway and clearway provided should permit compliance with the operational requirements for take-off and landing of the aeroplanes the runway is intended to serve.

— **Width of runways**

3.1.9 The width of a runway should not be less than the appropriate dimension specified in the following tabulation:

Code Number	Code Letter					
	A	B	C	D	E	F
1	18 ^a m	18 ^a m	23 m	-	-	-
2	23 ^a m	23 ^a m	30 m			-
3	30 m	30 m	30 m	45 m	-	-
4	-	-	45 m	45 m	45 m	60 m

- (a) For VFR day only operations by aircraft with a MCTOW below 5700 kg, the minimum runway width may be reduced to twice the outer main gear span.

The combinations of code numbers and letters for which widths are specified have been developed for typical aeroplane characteristics.

— **Separation of parallel runways**

Simultaneous operations

3.1.10 Where parallel runways are designed for simultaneous use under visual meteorological conditions only, the minimum distance between centre lines should be—

- 210 m where the higher code number is 3 or 4
- 150 m where the higher code number is 2
- 120 m where the higher code number is 1.

3.1.11 Where parallel runways are provided for simultaneous operations under instrument meteorological conditions, the minimum separation distance between their centre lines should be—

- 1035 m for independent parallel approaches
- 915 m for dependent parallel approaches
- 760 m for independent parallel departures
- 760 m for segregated parallel operations

except that for segregated parallel operations the specified separation distance—

- should be decreased by 30 m for each 150 m that the arrival runway is staggered toward the arriving aircraft, to a minimum of 300 m
- should be increased by 30 m for each 150 m that the arrival runway staggered away from the arriving aircraft.

Non-simultaneous operations

3.1.12 Where a parallel grass strip is adjacent to a paved runway a minimum separation of 10 m should exist between the edge of the paved runway and the edge of the grass strip for non-simultaneous operations.

— Slopes on runways***Longitudinal slopes***

3.1.13 The average slope of a runway is defined as the difference in elevation between the end points of the runway divided by the length of the runway, using common units. This is usually expressed as a percentage. The average slope of a runway should not be greater than 1% where the code number is 3 or 4 and 2% where the code number is 1 or 2.

3.1.14 Along no portion of a runway should the longitudinal slope exceed—

- (a) 1.25% where the code number is 4, except that for the first and last quarter of the length of the runway the longitudinal slope should not exceed 0.8%
- (b) 1.5% where the code number is 3, except that for the first and last quarter of the length of a precision approach runway category II or III the longitudinal slope should not exceed 0.8%
- (c) 2% where the code number is 1 or 2.

Longitudinal slope changes

3.1.15 Where slope changes cannot be avoided, a slope change between two consecutive slopes should not exceed—

- (a) 1.5% where the code number is 3 or 4
- (b) 2% where the code number is 1 or 2.

Transition rates

3.1.16 The transition rate from one slope to another is to be accomplished by a curved surface with a rate of change not exceeding—

- (a) 0.1% per 30 m (minimum radius of curvature of 30 000 m) where the code number is 4
- (b) 0.2% per 30 m (minimum radius of curvature of 15 000 m) where the code number is 3
- (c) 0.4% per 30 m (minimum radius of curvature of 7500 m) where the code number is 1 or 2.

Sight distance

3.1.17 Where slope changes cannot be avoided, they should be such that there will be an unobstructed line of sight from—

- (a) any point 3 m above the runway to all other points 3 m above the runway within a distance of at least half the length of the runway where the code letter is C, D, E or F
- (b) any point 2 m above the runway to all other points 2 m above the runway within a distance of at least half the length of the runway where the code letter is B
- (c) any point 1.5 m above the runway to all other points 1.5 m above the runway within a distance of at least half the length of the runway where the code letter is A.

Transverse slopes

3.1.18 To promote the most rapid drainage of water, the runway surface should, if practicable, be cambered except where a single cross-fall from high to low in the direction of the wind most frequently associated with rain would ensure rapid drainage. The transverse slope should ideally be—

- (a) 1.5% where the code letter is C, D, E or F
- (b) 2% where the code letter is A or B

but in any event should not exceed 1.5% or 2%, as applicable, nor be less than 1% except at runway or taxiway intersections where flatter slopes may be necessary.

The slope value should be consistent throughout the runway length.

For a cambered surface the transverse slope on each side of the centre line should be symmetrical.

— **Strength of runways**

3.1.19 A runway should be capable of withstanding the traffic of aeroplanes the runway is intended to serve.

— **Surface of runways**

The rule requirements for runway surfaces are contained in Part 139, Appendix C.1.

3.1.20 The surface of a runway must be constructed without irregularities that would result in loss in friction characteristics or otherwise adversely affect the take-off or landing of an aeroplane.

Surface irregularities may adversely affect the take-off or landing of an aeroplane by causing excessive bouncing, pitching, vibration, or other difficulties in the control of the aeroplane.

3.1.21 The surface of a paved runway should be so constructed as to provide good friction characteristics when the runway is wet.

3.1.22 Measurements of the friction characteristics of a new or resurfaced runway should be made with a continuous friction measuring device using self-wetting features in order to assure that the design objectives with respect to its friction characteristics have been achieved.

3.1.23 The average surface texture depth of a new surface should not be less than 1.0 mm.

3.1.24 When the surface is grooved or scored, the grooves or scoring should be either at right angles to the runway centre line or parallel to transverse joints that may or may not be at right angles to the runway centre line where applicable.

3.2 Runway shoulders

3.2.1 Runway shoulders should be provided for a runway where the code letter is D or E, and the runway width is less than 60 m.

3.2.2 Runway shoulders should be provided for a runway where the code letter is F

— **Width of runway shoulders**

3.2.3 The runway shoulders should extend symmetrically on each side of the runway so that the over-all width of the runway and its shoulders is not less than—

- 60 m where the code letter is D or E
- 75 m where the code letter is F.

— **Slopes on runway shoulders**

3.2.4 The surface of the shoulder that abuts the runway should be flush with the surface of the runway and its transverse slope should not exceed 2.5%.

— **Strength of runway shoulders**

3.2.5 A runway shoulder should be prepared or constructed so as to be capable, in the event of an aeroplane running off the runway, of supporting the aeroplane without inducing structural damage to the aeroplane and of the supporting ground vehicles which may operate on the shoulder.

3.3 Starter extension

— **General**

3.3.1 A starter extension may be established where additional take-off distance, take-off run or accelerate-stop distance is required but physical limitations do not allow provision of the mandatory runway or strip width.

— **Specifications**

3.3.2 A starter extensions should comply with the following.

- (a) A starter extension should be of equal load bearing strength to that of the runway.
- (b) Provided the length of the extension does not exceed 150 m, it may be narrower than the runway; but never less than two thirds the runway width.
- (c) The starter extension should lie symmetrically astride the runway centreline extension.
- (d) The sides of the associated strip should not be closer to the runway than the wing overhang of the largest aircraft (design aircraft) intended to use the runway, plus a safety margin of 8m.
- (e) The strip end need not be at right angles to the runway centre line.
- (f) The minimum distance between the strip end and any point of the starter extension end, or that enlarged area needed for aircraft to turn, should not be less than the wing overhang of the design aircraft, plus the greater of 8 m or 20% of the wingspan.

These distances may need to be increased to allow for the adverse effects of propeller or jet blast - for example where the extension stops at a public road and footpath.

3.3.3 Starter extensions will normally require a taxiway lead-in or widening at the end to allow aircraft to turn.

Example of starter extension taken from (UK) SRG CAP 138

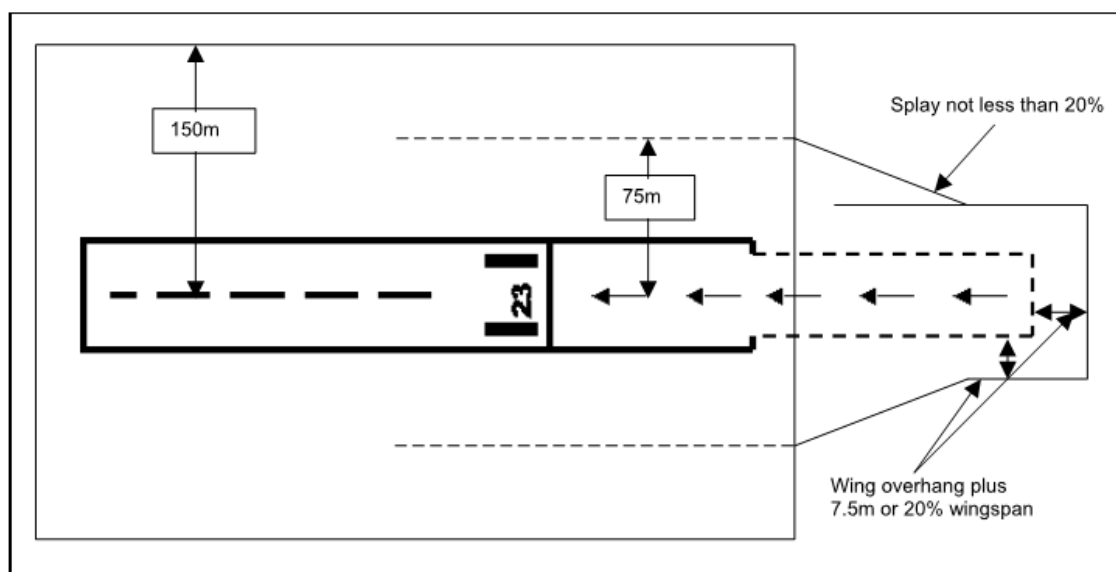

Figure 3H.2 Starter extension safeguarding

3.4 Runway turn pads

The rule requirement for runway turn pads are contained in Part 139, Appendix C.3.

— General

3.4.1 Where the end of a runway is not served by a taxiway or a taxiway turnaround a runway turn pad should be provided to facilitate a 180° turn of aeroplanes.

3.4.2 The runway turn pad may be located on either the left or right side of the runway and adjoining the runway pavement at both ends of the runway and at some intermediate locations where deemed necessary.

The initiation of the turn would be facilitated by locating the turn pad on the left side of the runway, since the left seat is the normal position of the pilot-in-command.

Such areas may also be useful if provided along a runway to reduce taxiing time and distance for aeroplanes which may not require the full length of the runway.

3.4.3 The intersection angle of the runway turn pad with the runway should not exceed 30°.

3.4.4 The nose wheel steering angle to be used in the design of the runway turn pad should not exceed 45°.

3.4.5 The design of a runway turn pad should be such that, when the cockpit of the aeroplane for which the turn pad is intended remains over the turn pad marking, the clearance distance between any wheel of the aeroplane landing gear and the edge of the turn pad should be not less than that given by the following tabulation:

Code letter	Clearance
A	1.5 m
B	2.25 m
C	3 m if the turn pad is intended to be used by aeroplanes with a

	wheel base less than 18 m or
	4.5 m if the turn pad is intended to be used by aeroplanes with a wheel base equal to or greater than 18 m.
D	4.5 m
E	4.5 m
F	4.5 m

Wheel base means the distance from the nose gear to the geometric centre of the main gear.

3.4.6 Where severe weather conditions and resultant lowering of surface friction characteristics prevail, a larger wheel-to-edge clearance of 6 m should be provided where the code letter is E or F.

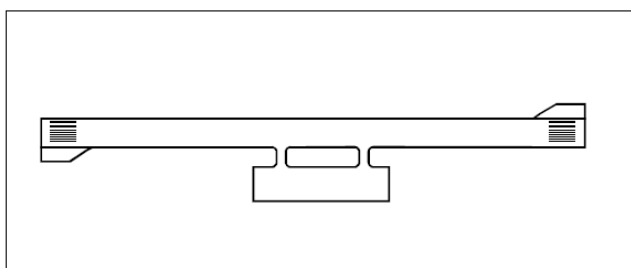

Figure 3-1. Typical turn pad layout

— **Slopes on runway turn pads**

3.4.7 The longitudinal and transverse slopes on a runway turn pad should be sufficient to prevent the accumulation of water on the surface and facilitate rapid drainage of surface water. The slopes should be the same as those on the adjacent runway pavement surface.

— **Strength of runway turn pads**

3.4.8 The strength of a runway turn pad should be at least equal to that of the adjoining runway which it serves, due consideration being given to the fact that the turn pad will be subjected to slow-moving traffic making hard turns and consequent higher stresses on the pavement.

Where a runway turn pad is provided with flexible pavement, the surface would need to be capable of withstanding the horizontal shear forces exerted by the main landing gear tires during turning manoeuvres.

— **Surface of runway turn pads**

3.4.9 The surface of a runway turn pad should not have surface irregularities that may cause damage to an aeroplane using the turn pad.

3.4.10 The surface of a runway turn pad should be so constructed as to provide good friction characteristics for aeroplanes using the facility when the surface is wet.

— **Shoulders for runway turn pads**

3.4.11 The runway turn pads should be provided with shoulders of such width as is necessary to prevent surface erosion by the jet blast of the most demanding aeroplane for which the turn pad is intended; and any possible foreign object damage to the aeroplane engines.

As a minimum, the width of the shoulders would need to cover the outer engine of the most demanding aeroplane and thus may be wider than the associated runway shoulders.

3.5 Runway strips

The rule requirements for runway strips are contained in Part 139, Appendix C.2.

— **General**

3.5.1 A runway and any associated stopway should be included in a strip.

— **Length of runway strips**

The rule requirements for runway strip lengths are contained in Part 139, Appendix C.2.1.

3.5.2 A strip should extend before the threshold and beyond the end of the runway or stopway for a distance of at least—

- 60 m where the code number is 3 or 4
- 30 m where the code number is 2
- 10 m where the code number is 1.

— **Width of runway strips**

The rule requirements for runway strip widths are contained in Part 139, Appendix C.2.2.

3.5.3 A strip should extend laterally on each side of the runway centre line and extended centre line throughout the length of the strip to the minimum distance determined in Part 139, Appendix C Table C-1.

— **Objects on runway strips**

The rule requirements for objects on runway strips are contained in Part 139, Appendix C.2.3.

See paragraph 8.4 for information regarding siting and construction of equipment and installations on runway strips.

3.5.4 An object situated on a runway strip which may endanger aeroplanes should be regarded as an obstacle and should, as far as practicable, be removed.

3.5.5 No fixed object, other than visual aids required for air navigation purposes and satisfying the relevant frangibility requirement in section 5, should be permitted on a runway strip—

- (a) within 75 m of the runway centre line of a precision approach runway category I, II or III where the code number is 3 or 4 and the code letter is F; or
- (b) within 60 m of the runway centre line of a precision approach runway category I, II or III where the code number is 3 or 4; or

- (c) within 45 m of the runway centre line of a precision approach runway category I where the code number is 1 or 2.

3.5.6 No mobile object should be permitted on this part of the runway strip during the use of the runway for landing or take-off.

— **Grading of runway strips**

The rule requirements for grading of runway strips are contained in Part 139, Appendix C.2.4.

3.5.7 A graded area should extend laterally on each side of the runway centre line and extended centre line throughout the length of the strip and stopway so that the overall width of the graded portion is as follows.

International Aerodromes			
	Instrument approach runway	Code 3 or 4	150 m
	Instrument approach runway	Code 1 or 2	80 m
Domestic Aerodromes			
	Instrument approach runway	Code 3 or 4	150 m
	Instrument approach runway	Code 1 or 2	80 m
	Non instrument approach runway	Code 3 or 4	150 m
	Non-instrument approach runway day only aircraft at or below 22700 kg MCTOW	Code 3 or 4	90 m
	Non-instrument runway night	Code 2	80 m
	Non-instrument runway night	Code 1	60 m
	Non-instrument runway day only	Code 1 or 2	2.5 x wingspan or 30 m, whichever is greater

3.5.8 The area within the strip but outside the graded area is provided for the over flight of an aircraft.

3.5.9 The surface of that portion of a strip that abuts a runway, shoulder or stopway should be flush with the surface of the runway, shoulder or stopway.

3.5.10 That portion of a strip to at least 30 m before a threshold should be prepared against blast erosion in order to protect a landing aeroplane from the danger of an exposed edge.

— **Slopes on runway strips**

Longitudinal slopes

3.5.11 A longitudinal slope along that portion of a strip to be graded should not exceed—

- 1.5% where the code number is 4
- 1.75% where the code number is 3
- 2% where the code number is 1 or 2.

Longitudinal slope changes

3.5.12 Slope changes on that portion of a strip to be graded should be as gradual as practicable and abrupt changes or sudden reversals of slopes avoided.

3.5.13 Slope changes before the threshold of a precision approach runway should be avoided or kept to a minimum on that portion of the strip within a distance of at least 30 m on each side of the extended centre line of the runway. Where slope changes cannot be avoided on this portion, the rate of change between two consecutive slopes should not exceed 2% per 30 m.

Transverse Slopes

3.5.14 The grading and preparation of the strip surface should be such as to prevent the collection of surface water at any point and to this end the transverse slope may be up to 2.5% where the code number is 3 or 4, and 3% where the code number is 1 or 2. Where rainfall is high and the need for rapid drainage from the runway surface is paramount then the first 3 m to 5m outwards from the runway edge may be graded to a slope value of up to 5%.

3.5.15 For strips where it may be more important to retain the natural cover and accept a steeper transverse slope, in order to preclude the risk of transverse scouring of the surface, any portion of a strip beyond that to be graded should not exceed an upward slope of 5% as measured in the direction away from the runway.

— Strength of runway strips

3.5.16 The strip should be so constructed as to minimise hazards to aircraft in the event of accidental run off from the runway. Where large turbine powered aircraft are expected to operate, special measures may be necessary in the preparation of the shoulders of the runway. Consideration should be given to additional strengthening of the shoulders.

3.5.17 In all cases where no specially prepared runway is provided, the full length and width of the strip should be acceptable for the ground movement of the aircraft for which the strip is designed. It is not expected that the outer half of the strip should be of equal bearing strength with the central portion but it should be of such strength that the aircraft running off the centrally prepared runway area will not sustain structural damage.

3.6 Runway end safety areas

The rule requirements for RESA are contained in Part 139, Appendix A.

— Strength of runway end safety areas

3.6.1 A runway end safety area should be so prepared or constructed as to reduce the risk of damage to an aeroplane undershooting or overrunning the runway, enhance aeroplane deceleration and facilitate the movement of rescue and fire fighting vehicles.

The surface of the ground in the RESA does not need to be prepared to the same quality as the runway strip.

3.7 Clearways

— Location of clearways

3.7.1 The origin of a clearway should be at the end of the take-off run available.

— **Length of clearways**

3.7.2 The length of a clearway should not exceed half the length of the take-off run available.

— **Width of clearways**

3.7.3 A clearway should extend laterally to a distance of at least 75 m on each side of the extended centre line of the runway.

— **Slopes on clearways**

3.7.4 The ground in a clearway should not project above a plane having an upward slope of 1.25%, the lower limit of this plane being a horizontal line which is—

- (a) perpendicular to the vertical plane containing the runway centre line
- (b) passing through a point located on the runway centre line at the end of the take-off run available.

3.7.5 Because of the transverse or longitudinal slopes on a runway, shoulder or strip, in certain cases the lower limit of the clearway plane specified above may be below the corresponding elevation of the runway, shoulder or strip. It is not intended that these surfaces be graded to conform with the lower limit of the clearway plane nor is it intended that terrain or objects which are above the clearway plane beyond the end of the strip but below the level of the strip be removed unless it is considered they may endanger aeroplanes.

3.7.6 Abrupt upward changes in slope should be avoided when the slope on the ground in a clearway is relatively small or when the mean slope is upward. In such situations, in that portion of the clearway within a distance of 22.5 m on each side of the extended centre line, the slopes, slope changes and the transition from runway to clearway should generally conform with those of the runway with which the runway is associated except that isolated depressions such as ditches running across the clearway may be permitted.

— **Objects on clearways**

3.7.7 An object situated on a clearway which may endanger aeroplanes in the air should be regarded as an obstacle and should be removed.

3.8 Stopways

The rule requirement for stopways is contained in Part 139, Appendix C4.

— **Width of stopways**

3.8.1 A stopway must have the same width as the runway with which it is associated.

— **Slopes on stopways**

3.8.2 Slopes and changes in slope on a stopway, and the transition from a runway to a stopway, should comply with the specifications of 3.1.13 to 3.1.18 for the runway with which the stopway is associated except that—

- (a) the limitation in 3.1.14 of a 0.8% slope for the first and last quarter of the length of a runway need not be applied to the stopway
- (b) At the junction of the stopway and runway and along the stopway the maximum rate of slope change may be 0.3% per 30 m (minimum radius of curvature of 10 000 m) for a runway where the code number is 3 or 4.

— **Strength of stopways**

3.8.3 A stopway should be prepared or constructed so as to be capable, in the event of an abandoned take-off, of supporting the aeroplane which the stopway is intended to serve without inducing structural damage to the aeroplane.

— **Surface of stopways**

3.8.4 The surface of a paved stopway should be so constructed as to provide a good coefficient of friction when the stopway is wet.

3.8.5 The friction characteristics of an unpaved stopway should not be substantially less than that of the runway with which the stopway is associated.

3.9 Taxiways

The rule requirements for taxiways are contained in Part 139, Appendix C.5.

— **General**

3.9.1 Taxiways should be provided to ensure safe and rapid movement of aircraft between the runway and apron areas.

Where the end of a runway is not served by a taxiway, it may be necessary to provide additional pavement at the end of the runway for the turning of aeroplanes. Such areas may also be useful along the runway to reduce taxiing time and distance for some aeroplanes.

3.9.2 A system may comprise a single taxiway or a complex of taxiways according to the volume of traffic expected.

3.9.3 In planning the route of a taxiway, factors to consider include—

- need to facilitate the ground movement of aircraft by the shortest distance
- avoidance of traffic congestion or confliction
- clearance from other taxiways and fixed obstructions
- minimising crossing of other runways or other active areas.

3.9.4 The surface of a taxiway should be kept clear of loose stones or other objects that may damage aircraft. Where jet engined aircraft use a taxiway, the verges on either side should also be kept clear of such objects.

— **Clearance distance on taxiways**

3.9.5 The design of a taxiway should be such that, when the cockpit of the aeroplane remains over the taxiway centre line markings, the clearance distance between the outer main wheels of the aeroplane and the edge of the pavement must not be less than determined in Part 139, Appendix C, Table C-2.

— Width of taxiways

3.9.6 The width of a taxiway is determined in relation to the size of the aircraft to be catered for. A straight portion of taxiway should have a width of not less than that given by the following tabulation—

Code letter	Taxiway width
A	7.5 m;
B	10.5 m;
C	15 m
D	18 m if the taxiway is intended to be used by aircraft with an outer main gearwheel span of less than 9 m; or
	23 m if the taxiway is intended to be used by aircraft with an outer main gearwheel span equal to or greater than 9 m.
E	23 m
F	25 m

Taxiway curves

3.9.7 Changes in direction of taxiways should be as few and small as possible. The radii of the curves should be compatible with the manoeuvring capability and normal taxiing speeds of the aeroplanes for which the taxiway is intended. The design of the curve should be such that, when the cockpit of the aeroplane remains over the taxiway centre line markings, the clearance distance between the outer main wheels of the aeroplane and the edge of the pavement should not be less than those specified in paragraph 3.8.5.

— Junctions and intersections

3.9.8 To facilitate the movement of aeroplanes, fillets should be provided at junctions and intersections of taxiways with runways, aprons and other taxiways. The design of the fillets should ensure that the minimum wheel clearances specified in paragraph 3.9.5 are maintained when aeroplanes are manoeuvring through the junctions or intersections.

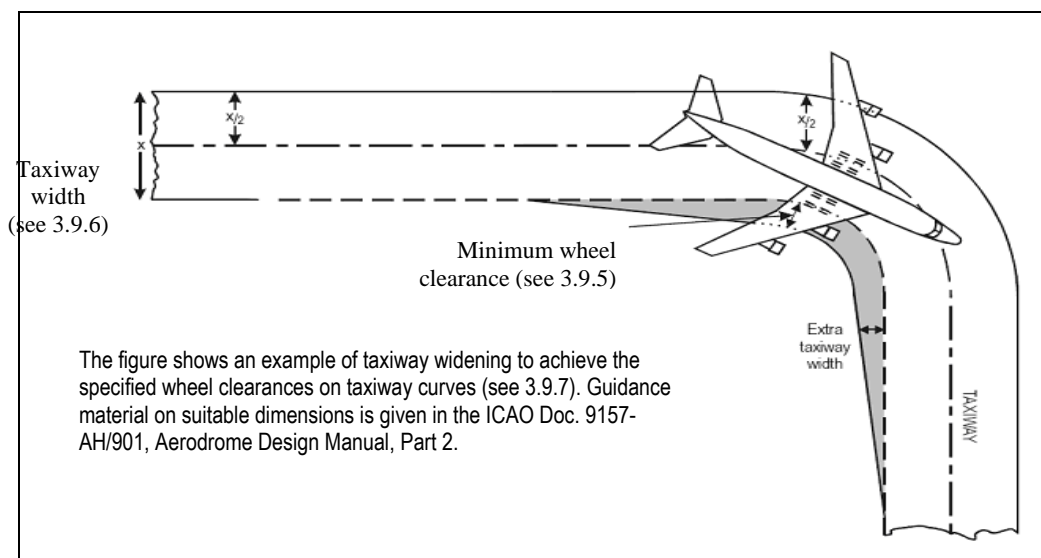

Figure 3-2. Taxiway curve

— Taxiway minimum separation distances

3.9.9 The separation distance between the centre line of a taxiway and the centre line of a runway, the centre line of a parallel taxiway or an object should not be less than the appropriate dimensions specified in Table 3-1, except that it may be permissible to operate with lower separation distances at an existing aerodrome if an aeronautical study indicates that such lower separation distances would not adversely affect the safety or significantly affect the regularity of operations of aeroplanes.

The distances given in Table 3-1 represent ordinary combinations of runways and taxiways using the largest aircraft likely to use that combination. Where a specific aircraft type is to be used the clearances may be adjusted accordingly.

Table 3-1. Taxiway minimum separation distances

Code Letter	Distance between taxiway centre line and runway centre line (metres)								Taxiway centre line to taxiway centre line (metres)	Taxiway other than aircraft stand taxi-lane centre line to object (metres)	Aircraft stand taxilane centre line to aircraft stand taxilane centre line(met res)	Aircraft stand taxi-lane centre line to object (metres)
	Instrument runways				Non-instrument runways							
	Code number				Code number							
	1	2	3	4	1	2	3	4				
(1)	(2)	(3)	(4)	(5)	(6)	(7)	(8)	(9)	(10)	(11)	(12)	(13)
A	82.5	82.5	-	-	37.5	47.5	-	-	23	15.5	19.5	12
B	87	87	-	-	42	52	-	-	32	20	28.5	16.5
C	-	-	168	-	-	-	93	-	44	26	40.5	22.5
D	-	-	176	176	-	-	101	101	63	37	59.5	33.5
E	-	-	-	182.5	-	-	-	107.5	76	43.5	72.5	40
F	-	-	-	190	-	-	-	115	91	51	87.5	47.5

The separation distances shown in columns (2) to (9) represent ordinary combinations of runways and taxiways. The basis for development of these distances is given in the Aerodrome Design Manual (ICAO Doc 9157), Part 2.

— **Slopes on taxiways**

Longitudinal slopes

3.9.10 The longitudinal slope on a taxiway should not exceed—

- 1.5% where the code letter is C, D, E or F
- 3% where the code letter is A or B.

Longitudinal slope changes

3.9.11 Where slope changes cannot be avoided, the transition from one slope to another slope should be accomplished by a curved surface with a rate of change not exceeding—

- 1% per 30 m (minimum radius of curvature of 3000 m) where the code letter is C, D, E or F
- 1% per 25 m (minimum radius of curvature of 2500 m) where the code letter is A or B.

Sight distance

3.9.12 Where a change in slope on a taxiway cannot be avoided, the change should be such that, from any point—

- 3 m above the taxiway; it will be possible to see the whole surface of the taxiway for a distance of at least 300 m from that point, where the code letter is C, D, E or F;
- 2 m above the taxiway; it will be possible to see the whole surface of the taxiway for a distance of at least 200 m from that point, where the code letter is B; and
- 1.5 m above the taxiway; it will be possible to see the whole surface of the taxiway for a distance of at least 150 m from that point, where the code letter is A.

Transverse slopes

3.9.13 The transverse slope for a taxiway should be sufficient to prevent the accumulation of water on the surface of the taxiway but should not exceed—

- 1.5% where the code letter is C, D, E or F
- 2% where the code letter is A or B.

See paragraph 3.12.4 regarding transverse slopes on an aircraft stand taxi-lane.

— **Strength of taxiways**

3.9.14 The strength of a taxiway should be at least equal to that of the runway it serves, due consideration being given to the fact that a taxiway will be subjected to a greater density of traffic and, as a result of slow moving and stationary aeroplanes, to higher stresses than the runway it serves.

— **Surface of taxiways**

3.9.15 The surface of a taxiway should not have irregularities that may cause damage to aeroplane structures.

3.9.16 The surface of a paved taxiway should be so constructed as to provide good friction characteristics when the taxiway is wet.

— Taxiways on bridges

The rule requirements for taxiway bridges are contained in Part 139, Appendix C.6.

3.9.17 The width of that portion of a taxiway bridge capable of supporting aeroplanes, as measured perpendicular to the taxiway centre line, must not be less than the width of the graded area of the strip provided for that taxiway, unless a proven method of lateral restraint is provided which must not be hazardous for aeroplanes for which the taxiway is intended.

When a width less than the width of the graded area of the strip is provided, consideration will have to be given to access by rescue and fire fighting vehicles to intervene in both directions within the specified response time to the largest aeroplane for which the taxiway bridge is intended.

If aeroplane engines overhang the bridge structure, protection of adjacent areas below the bridge from engine blast may be required.

3.9.18 A bridge should be constructed on a straight section of taxiway with a straight section on both ends of the bridge to facilitate the alignment of aeroplanes approaching the bridge.

— Rapid Exit Taxiways

Note: *The following specifications detail requirements particular to rapid exit taxiways. See Figure 3-3. General requirements for taxiways also apply to this type of taxiway. Guidance on the provision, location and design of rapid exit taxiways is included in the Aerodrome Design Manual (ICAO Doc 9157), Part 2.*

3.9.19 A rapid exit taxiway should be designed with a radius of turn-off curve of at least—

- 550 m where the code number is 3 or 4
- 275 m where the code number is 1 or 2

to enable exit speeds under wet conditions of—

- 93 km/h where the code number is 3 or 4
- 65 km/h where the code number is 1 or 2.

The locations of rapid exit taxiways along a runway are based on several criteria described in the Aerodrome Design Manual (ICAO Doc 9157), Part 2, in addition to different speed criteria.

3.9.20 The radius of the fillet on the inside of the curve at a rapid exit taxiway should be sufficient to provide a widened taxiway throat in order to facilitate early recognition of the entrance and turn-off onto the taxiway.

3.9.21 A rapid exit taxiway should include a straight distance after the turn-off curve sufficient for an exiting aircraft to come to a full stop clear of any intersecting taxiway.

3.9.22 The intersection angle of a rapid exit taxiway with the runway should not be greater than 45° nor less than 25° and preferably should be 30°.

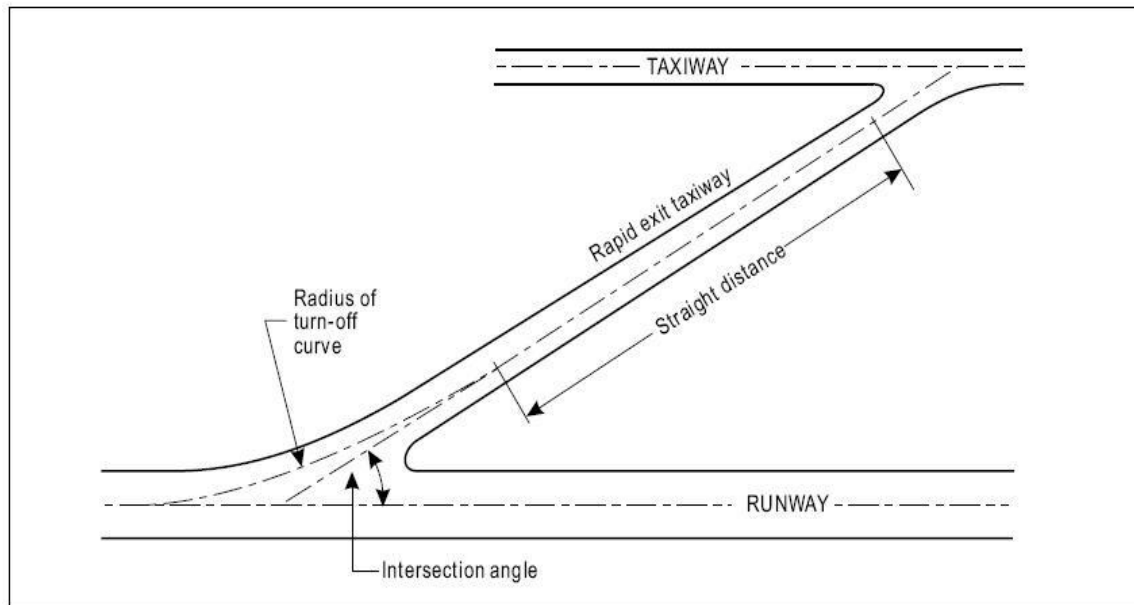

Figure 3-3. Rapid exit taxiway

3.10 Taxiway shoulders

3.10.1 Straight portions of a taxiway where the code letter of the aircraft intending to use the taxiway is C, D or E should be provided with shoulders which extend symmetrically on each side of the taxiway so that the overall width of the taxiway and its shoulders on straight portions is not less than—

- 60 m where the code letter is F
- 44 m where the code letter is E
- 38 m where the code letter is D
- 25 m where the code letter is C.

3.10.2 When a taxiway is intended to be used by turbine-engined aircraft, the surface of the taxiway shoulder should be so prepared as to resist erosion and the ingestion of surface material by aeroplane engines.

3.11 Taxiway strips

The rule requirements for taxiway strips are contained in Part 139, Appendix C.7.

— Width of taxiway strips

3.11.1 A taxiway, other than an aircraft stand taxi-lane, must be included in a strip.

3.11.2 A taxiway strip should extend symmetrically on each side of the centre line of the taxiway throughout the length of the taxiway to at least the distance from the centre line given in Table 3-1, Column 11.

— Objects on taxiway strips

3.11.3 The taxiway strip should provide an area clear of objects which may endanger taxiing aeroplanes.

— **Grading of taxiway strips**

3.11.4 The centre portion of a taxiway strip should provide a graded area to a distance from the centre line of the taxiway of at least—

- 11 m where the code letter is A
- 12.5 m where the code letter is B or C
- 19 m where the code letter is D
- 22 m where the code letter is E
- 30 m where the code letter is F.

— **Slopes on taxiways strip**

3.11.5 The surface of the strip should be flush at the edge of the taxiway or shoulder, if provided, and the graded portion should not have an upward transverse slope exceeding—

- 2.5% for strips of taxiways where the code letter is C, D, E or F
- 3% for strips of taxiways where the code letter is A or B.

3.11.6 The upward slope being measured with reference to the transitional slope of the adjacent taxiway surface and not the horizontal. The downward transverse slope should not exceed 5% measured with reference to the horizontal.

3.11.7 The transverse slopes on any portion of a taxiway strip beyond that to be graded should not exceed an upward slope of 5% as measured in the direction away from the taxiway.

3.12 Holding bays, runway-holding positions, intermediate holding positions and road-holding positions

The rule requirements for holding positions are contained in Part 139, Appendix C.8.

— **General**

3.12.1 Holding bay(s) should be provided when the traffic density is medium or heavy.

3.12.2 A runway-holding position or positions must be provided—

- on the taxiway, at an intersection of a taxiway with a runway
- at an intersection of a runway with another runway when the former runway is part of a standard taxi-route.

3.12.3 A runway-holding position must be established on a taxiway if the location or alignment of the taxiway is such that a taxiing aircraft or vehicle can infringe an obstacle limitation surface or interfere with the operation of radio navigation aids.

3.12.4 An intermediate holding position must be established on a taxiway at any point other than a runway-holding position where it is desirable to define a specific holding limit.

3.12.5 A road-holding position must be established at an intersection of a road with a runway.

— **Location**

3.12.6 The distance between a holding bay or a road-holding position and the centre line of a runway should be in accordance with Table 3-2 and, in the case of a precision approach runway, such that a holding aircraft will not interfere with the operation of radio aids.

3.12.7 At elevations greater than 700 m (2300 ft.) the distance of 90 m specified in Table 3-2 for a precision approach runway code number 4 should be increased as follows—

- up to an elevation of 2000 m; 1 m for every 100 m in excess of 700 m
- elevation in excess of 2000 m and up to 4000 m; 13m plus 1.5m for every 100 m in excess of 4000 m
- elevation in excess of 4000 m and up to 5000 m; 43 m plus 2 m for every 100 m in excess of 4000 m.

3.12.8 If a holding bay, runway holding position or road-holding position for a precision approach runway code number 4 is at a greater elevation compared to the threshold, the distance of 90 m or 107.5 m, as appropriate, specified in Table 3-2 should be further increased 5 m for every metre the bay or position is higher than the threshold.

3.12.9 The location of a runway-holding position established in accordance with paragraph 3.12.3 should be such that a holding aircraft or vehicle will not infringe that obstacle free zone, approach surface, take-off climb surface or ILS/MLS critical/sensitive area or interfere with the operation of radio navigation aids.

Table 3-2. Minimum distance from the runway centre line to a holding bay or taxi-holding position

Type of runway	Code number			
	1	2	3	4
Non-instrument	30 m	40 m	75 m	75 m
Non-precision approach	40 m	40 m	75 m	75 m
Precision approach category I	60 m ^b	60 m ^b	90 m ^{a,b}	90 m ^{a,b,c}
Precision approach categories II and III	–	–	90 m ^{a,b}	90 m ^{a,b,c}
Take-off runway	30 m	40 m	75 m	75 m

- (a) If a holding bay or taxi-holding position is at a lower elevation compared to the threshold the distance may be decreased 5 m for every metre the bay or holding position is lower than the threshold. The converse applies if the bay or holding position is higher than the threshold
- (b) This distance may need to be increased to avoid interference with radio aids: for a precision approach runway category III the increase may be in the order of 50 m.
- (i) *The distance of 90 m for code number 3 or 4 is based on an aircraft with a tail height of 20 m, a distance from the nose to the highest part of the tail of 52.7 m and a nose height of 10 m holding at an angle of 45° or more with respect to the runway centre line, being clear of the obstacle free zone and not accountable for the calculation of OCA/H.*
- (ii) *The distance of 60 m for code number 2 is based on an aircraft with a tail height of 8 m, at a distance from the nose to the highest part of the tail of 24.6 m and a nose height of 5.2 m holding at an angle of 45° or more with respect to the runway centre line, being clear of the obstacle free zone.*
- (iii) *Where the code letter is F, this distance should be 107.5 m*

The distance of 107.5 m for code number 4 where the code letter is F is based on an aircraft with a tail height of 24 m, at a distance from the nose to the highest part of the tail of 62.2 m and a nose height of 10m holding at an angle of 45° or more with respect to the runway centre line, being clear of the obstacle free zone.

— Low minima operations

3.12.10 Where a runway is capable of being used under conditions of low cloud base and visibility, the holding positions applicable to such operations should be marked at a distance from the runway centre line such that the holding aircraft will not constitute an obstacle within the strip area associated with operations under such minima.

3.13 Aprons

3.13.1 Aprons should be provided where necessary to permit the on- and off-loading of passengers, cargo or mail as well as servicing of aircraft without interfering with the aerodrome traffic.

— **Size of aprons**

3.13.2 The overall dimensions of an apron area are determined by several controlling factors. These include the size of the aeroplanes expected to serve the aerodrome and the ground area covered by the most demanding aircraft in manoeuvring onto and from the parking positions; the number of parking positions to be provided to permit expeditious handling of aeroplane movements and the volume of traffic anticipated for the aerodrome.

On aprons, consideration should also be given to the provision of service roads and to the manoeuvring and storage area for ground equipment.

— **Strength of aprons**

3.13.3 Each part of an apron should be capable of withstanding the traffic of the aircraft it is intended to serve, due consideration being given to the fact that some portions of the apron will be subjected to a higher density of traffic and, as a result of slow moving or stationary aircraft, to higher stresses than a runway.

— **Slopes on aprons**

3.13.4 Slopes on aprons, including those on an aircraft stand taxi-lane, should be sufficient to prevent accumulation of water on the surface of the apron but should be kept as level as drainage requirements permit.

3.13.5 The slope should not exceed 1% and should slope away from the terminal building so as to reduce the danger of any build-up of spilt fuel at the base of the terminal building.

— **Clearance distances on aircraft stands**

Aircraft to object

3.13.6 An aircraft stand should provide the following minimum clearances between an aircraft entering or exiting the stand and any adjacent building, aircraft on another stand and other objects—

Code Letter	Clearance
A, B	3 m
C	4.5 m
D, E and F	7.5 m

When special circumstances so warrant, these clearances may be reduced at a nose-in aircraft stand, where the code letter is D, E or F—

- between the terminal, including any fixed passenger bridge, and the nose of an aircraft
- over any portion of the stand provided with azimuth guidance by a visual guidance system.

On aprons, consideration also has to be given to the provision of service roads and to manoeuvring and storage area for ground equipment. (Refer Aerodrome Design Manual (Doc 9157), Part 2 - for guidance on storage of ground equipment).

— **Aircraft to apron edge**

3.13.7 The layout of the nose wheel guidelines should be such that, when the nose wheel of the aeroplane remains on a guideline, the clearance distance between the outer main wheels of the aeroplane and the apron edge, whether taxiing in a straight line or turning a corner, should not be less than—

Code Letter	Clearance
A	1.3 m
B	1.9 m
C	2.6 m if the apron is intended to be used by aeroplanes with a wheel base less than 18 m; or
	3.8 m if the apron is intended to be used by aeroplanes with a wheel base equal to or greater than 18 m;
D, E or F	3.8 m

3.14 Isolated aircraft parking position

3.14.1 An isolated aircraft parking position should be designated or the aerodrome control tower should be advised of an area or areas suitable for the parking of an aircraft which is known or believed to be the subject of unlawful interference, or which for other reasons needs isolation from normal aerodrome activities.

3.14.2 The isolated parking position should be located at a maximum distance practicable and in any case not less than 100 m from other parking positions, buildings or public areas, and suchlike. Care should be taken to ensure that the position is not located over underground utilities such as gas and aviation fuel and, to the extent feasible, electrical or communication cables.

3.15 De-icing/anti-icing facilities

— **General**

3.15.1 Aeroplane de-icing/anti-icing facilities should be provided at an aerodrome where icing conditions are expected to occur.

— **Location**

3.15.2 De-icing/anti-icing facilities should be provided either at aircraft stands or at specified remote areas along the taxiway leading to the runway meant for take-off, provided that adequate drainage arrangements for the collection and safe disposal of excess de-icing/anti-icing fluids are available to prevent ground water contamination. The effect of volume of traffic and departure flow rates should also be considered.

One of the primary factors influencing the location of a de-icing/anti-icing facility is to ensure that the holdover time of the anti-icing treatment still in effect at the end of taxiing and when take-off clearance of the treated aeroplane is given.

Remote facilities compensate for changing weather conditions when icing conditions or blowing snow are expected to occur along the taxi-route taken by the aeroplane to the runway meant for take-off.

3.15.3 The remote de-icing/anti-icing facility should be located to be clear of the obstacle limitation surfaces specified in section 4, not cause interference to the radio navigation aids and be clearly visible from the air traffic control tower for clearing the treated aeroplane.

3.15.4 The remote de-icing/anti-icing facility should be so located as to provide for an expeditious traffic flow, perhaps with a bypass configuration, and not require unusual taxiing manoeuvre into and out of the pads.

The jet blast effects caused by a moving aeroplane on other aeroplanes receiving the anti-icing treatment or taxiing behind will have to be taken into account to prevent degradation of the treatment.

— **Size and number of de-icing/anti-icing pads**

An aeroplane de-icing/anti-icing pad consists of a) an inner area for parking of an aeroplane to be treated, and b) an outer area for movement of two or more mobile de-icing/anti-icing equipment.

3.15.5 The size of a de-icing/anti-icing pad should be equal to the parking area required by the most demanding aeroplane in a given category with at least 3.8 m clear paved area all-round the aeroplane for the movement of the de-icing/anti-icing vehicles.

Where more than one de-icing/anti-icing pad is provided, consideration will have to be given to providing de-icing/anti-icing vehicle movement areas of adjacent pads that do not overlap, but are exclusive for each pad. Consideration will also need to be given to bypassing of the area by other aeroplanes with the clearances specified in paragraphs 3.15.9 and 3.15.10.

3.15.6 The number of de-icing/anti-icing pads required should be determined based on the meteorological conditions, the type of aeroplanes to be treated, the method of application of de-icing/anti-icing fluid; the type and capacity of the dispensing equipment used, and the departure flow rates.

— **Slopes on de-icing/anti-icing pads**

3.15.7 The de-icing/anti-icing pads should be provided with suitable slopes to ensure satisfactory drainage of the area and to permit collection of all excess de-icing/anti-icing fluid running off an aeroplane. The maximum longitudinal slope should be as little as practicable and the transverse slope should not exceed 1%.

— **Strength of de-icing/anti-icing pads**

3.15.8 The de-icing/anti-icing pad should be capable of withstanding the traffic of the aircraft it is intended to serve, due consideration being given to the fact that the de-icing/anti-icing pad (like an apron) will be subjected to a higher density of traffic and, as a result of slow-moving or stationary aircraft, to higher stresses than a runway.

— **Clearance distances on a de-icing/anti-icing pad**

3.15.9 A de-icing/anti-icing pad should provide the minimum clearances specified in paragraph 3.13.6 for aircraft stands. If the pad layout is such as to include bypass configuration, the minimum separation distances specified in Table 3-1, column 12, should be provided.

3.15.10 Where the de-icing/anti-icing facility is located adjoining a regular taxiway, the taxiway minimum separation distance specified in Table 3-1, column 11, should be provided. (See Figure 3-4)

— **Environmental considerations**

The excess de-icing/anti-icing fluid running off an aeroplane poses the risk of contamination of ground water in addition to affecting the pavement surface friction characteristics.

3.15.11 Where de-icing/anti-icing activities are carried out, the surface drainage should be planned to collect the run-off separately, preventing its mixing with the normal surface run-off so that it does not pollute the ground water.

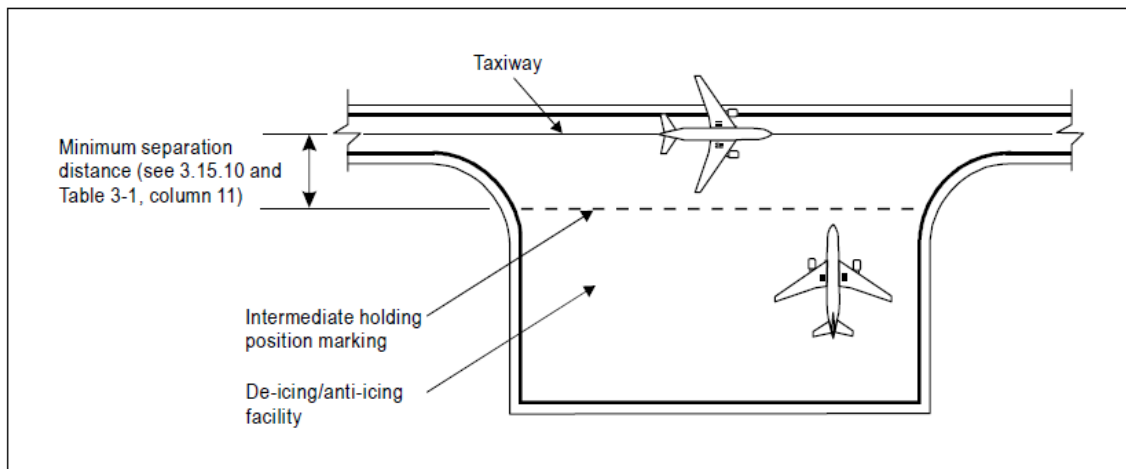

Figure 3-4. Minimum separation distance on a de-icing/anti-icing facility

4. OBSTACLE RESTRICTION AND REMOVAL

The obstacle limitation surfaces of an aerodrome are defined surfaces in the airspace above and adjacent to the aerodrome. These obstacle limitation surfaces are necessary to enable aircraft to maintain a satisfactory level of safety while manoeuvring at low altitude in the vicinity of the aerodrome. These surfaces should be free of obstacles and subject to control such as the establishment of zones, where the erection of buildings, masts and so on, are prohibited. Where obstructions infringe these surfaces they may, subject to the conduct of an aeronautical study, be removed, reduced in height, marked and lit.

The rule requirements for obstacle restriction and removal are contained in Part 139, Appendix D.1.

4.1 Limitation surface

— Conical surface

Description

4.1.1 A surface sloping upwards and outwards from the periphery of the inner horizontal surface. See Figures 4-1 and Fig 4-2.

Characteristics

4.1.2 The lower edge is coincident with the periphery of the inner horizontal surface and rises to an elevation of 150 m above the aerodrome datum level. It rises upwards and outwards from the periphery of the inner horizontal surface at a gradient of 5%.

4.1.3 The slope is measured in a vertical plane perpendicular to the periphery of the inner horizontal surface.

— Inner horizontal surface

Description

4.1.4 A surface located in a horizontal plane above an aerodrome and its environment. See Figures 4-1 and 4-2.

Characteristics

4.1.5 The inner horizontal surface is contained in a horizontal plane having its outer limits at a specified distance measured from the periphery of the runway strip.

4.1.6 The plane is located 45 m above the aerodrome elevation datum.

Outer horizontal surface

Description

4.1.7 A specified portion of a horizontal plane located above the environment of an aerodrome beyond the horizontal limits of the conical surface

Characteristics

4.1.8 As a broad specification for the outer horizontal surface, tall structures can be considered to be of possible significance if they are both higher than 30 m above local ground level, and higher than 150 m above aerodrome elevation within a radius of 15000 m of the centre of the airport where the runway code number is 3 or 4.

4.1.9 The area of concern may need to be extended to coincide with the obstacle-accountable areas of PANSOPS for the individual approach procedures at the airport under consideration.

— **Approach surface**

Each strip should be provided with an inclined approach surface such that aeroplanes approaching to land have a clear, obstacle-free path with a guaranteed clearance surface. This approach path is located within a defined area called the approach fan.

Description

4.1.10 The origin of the approach fan is an inclined plane originating at a specified distance prior to the runway threshold.

Characteristics

4.1.11 The fan is essentially a truncated triangle with the cut-off apex line called the inner edge (see Figures 4-2 and 4-3). The length of this inner edge is specified in Table 4-1.

4.1.12 The expanding sides of the approach fan diverge at a constant rate related to a percentage of the distance from the end of the strip, and extend to a specified distance from the origin. Refer Table 4-1.

Elevation

4.1.13 The elevation of the inner edge of the approach fan should be the same as the highest point on the extended centre line between the threshold and the inner edge.

4.1.14 The slope of the approach surface should be measured in the vertical plane containing the centre line of the runway.

— **Inner Approach surface**

Description

4.1.15 A rectangular portion of the approach surface immediately preceding the threshold.

Characteristics

4.1.16 The limits of the inner approach surface should comprise—

- (a) an inner edge coincident with the location of the inner edge of the approach surface but of its own specified length
- (b) two sides originating at the ends of the inner edge and extending parallel to the vertical plane containing the centreline of the runway
- (c) an outer edge parallel to the inner edge.

— **Transitional side surface**

Description

4.1.17 A complex surface originating along the side of the strip and part of the side of the approach surface that slopes upwards and outwards to the inner horizontal surface. See Figures 4-1 and 4-2.

Characteristics

4.1.18 From the sides of the strip and the approach surface, the transitional side surface slopes upwards and outwards at a specified gradient, extending until it reaches the inner horizontal

surface. Except for a boundary fence or hedge sited along the edge of a strip, no obstacle should penetrate the transitional side surface. Where obstacles penetrate this surface, an aeronautical study should be conducted to determine if any such object is required to be removed, reduced in height, marked or lit.

— **Inner transitional surface**

It is intended that the inner transitional surface be the controlling obstacle limitation surface for navigation aids, aircraft and other vehicles that must be near the runway and which is not to be penetrated except for frangible objects. The transitional surface described in paragraph 4.1.14 is intended to remain as the controlling obstacle limitation surface for buildings, etc.

Description

4.1. 19 A surface similar to the transitional surface but closer to the runway.

Characteristics

4.1. 20 The limits of an inner transitional surface should comprise—

- (a) lower edge beginning at the end of the inner approach surface and extending down the side of the inner approach surface to the inner edge of that surface, from there along the strip parallel to the runway centre line to the inner edge of the balked landing surface and from there up the side of the balked landing surface to the point where the side intersects the inner horizontal surface
- (b) an upper edge located in the plane of the inner horizontal surface.

4.1. 21 The elevation of a point on the lower edge should be—

- (a) along the side of the inner approach surface and balked landing surface —equal to the elevation of the particular surface at that point; and
- (b) along the strip — equal to the elevation of the nearest point on the centre line of the runway or its extension.

As a result of (b) the inner transitional surface along the strip will be curved if the runway profile is curved or a plane if the runway profile is a straight line. The intersection of the inner transitional surface with the inner horizontal surface will also be a curved or straight line depending on the runway profile.

4.1. 22 The slope of the inner transitional surface should be measured in a vertical plane at right angles to the centre line of the runway.

— **Balked landing surface**

Description

4.1. 23 An inclined plane located at a specified distance after the threshold, extending between the inner transitional surface.

Characteristics

4.1. 24 The limits of the balked landing surface should comprise—

- (a) an inner edge horizontal and perpendicular to the centre line of the runway and located at a specified distance after the threshold

- (b) two sides originating at the ends of the inner edge and diverging uniformly at a specified rate from the vertical plane containing the centre line of the runway
- (c) an outer edge parallel to the inner edge and located in the plane of the inner horizontal surface.

4.1. 25 The elevation of the inner edge should be equal to the elevation of the runway centre line at the location of the inner edge.

4.1. 26 The slope of the balked landing surface should be measured in the vertical plane containing the centre line of the runway.

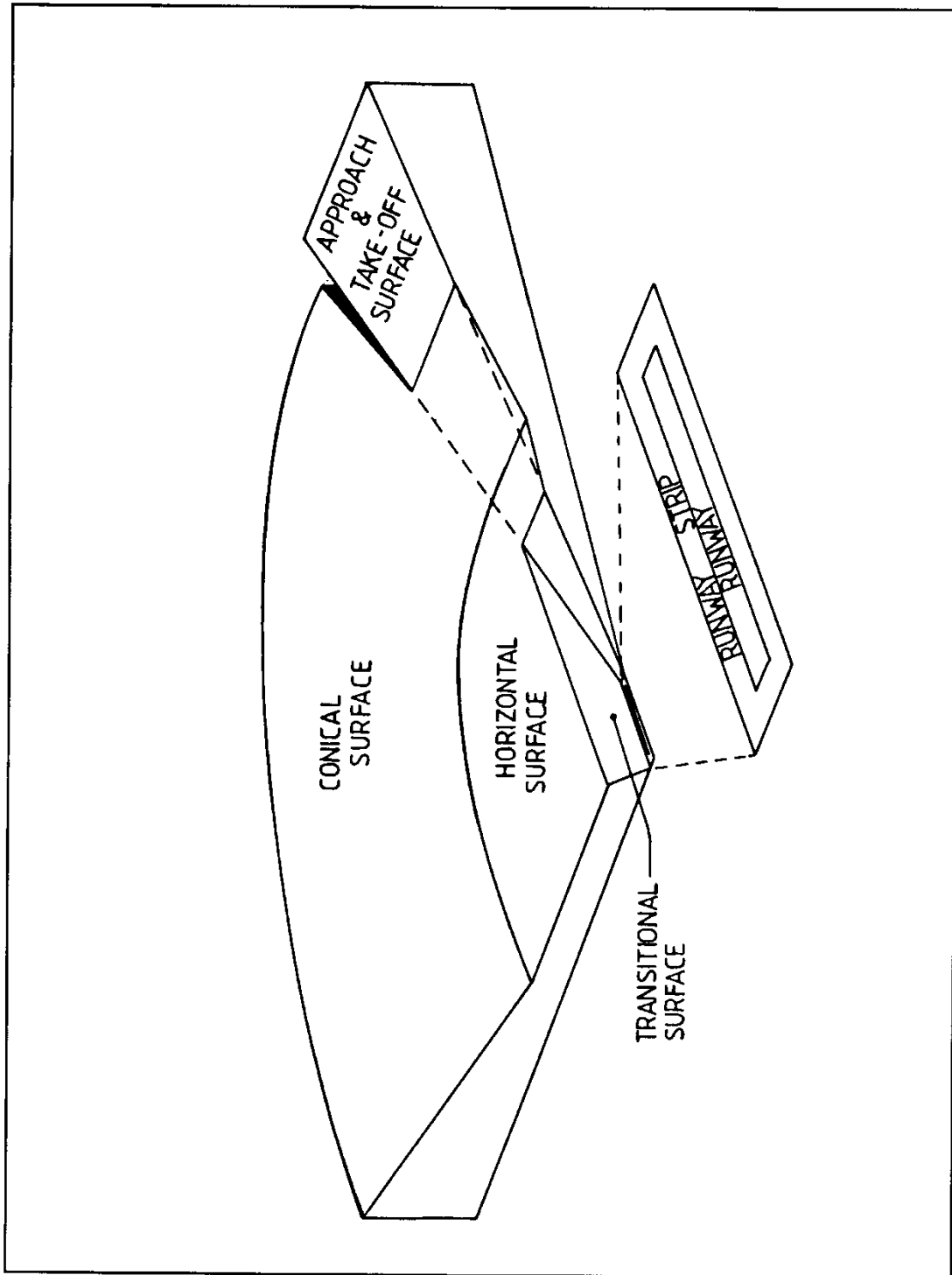

Figure 4-1. Obstacle limitation surfaces

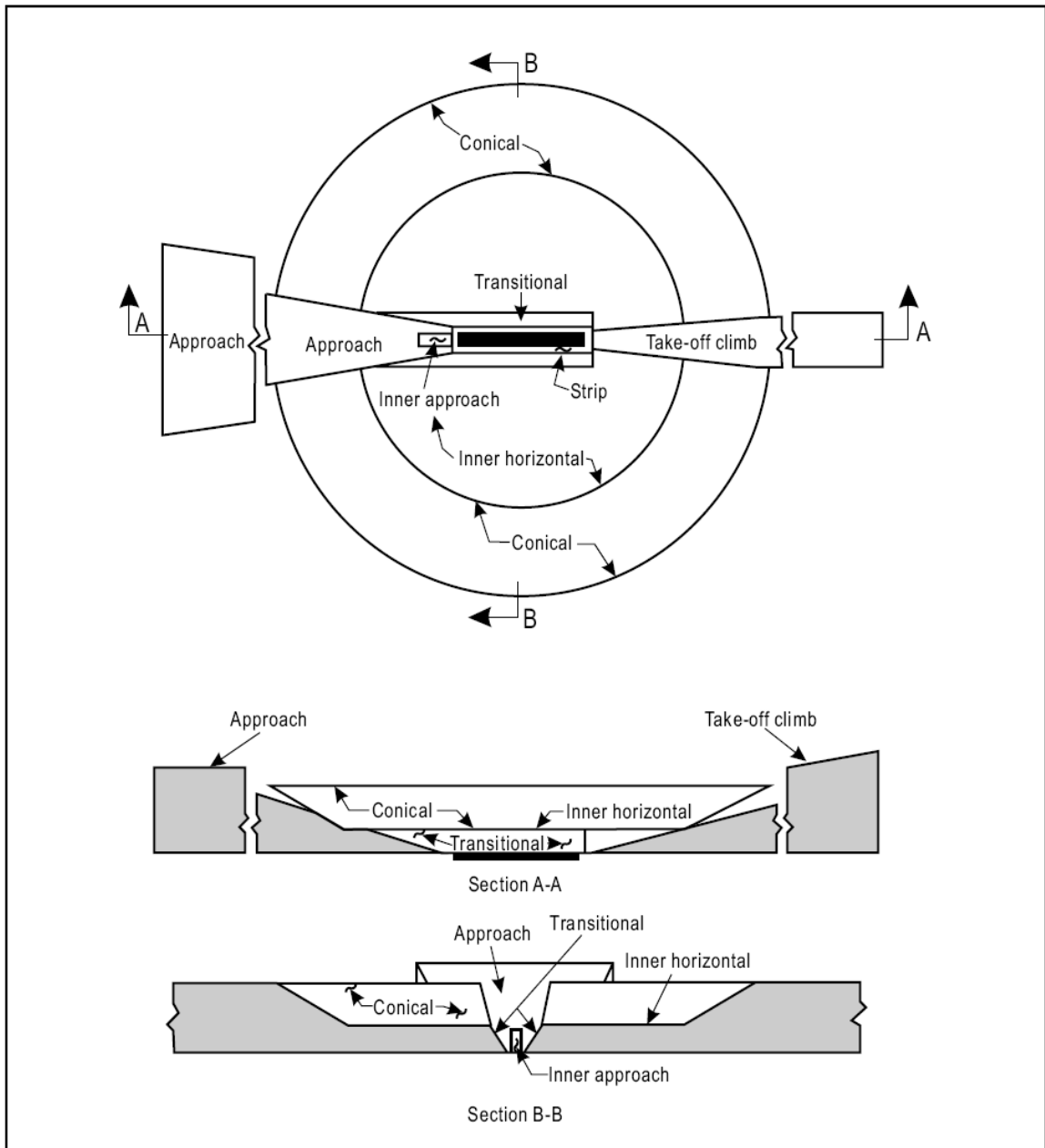

Figure 4-2 Obstacle limitation surfaces

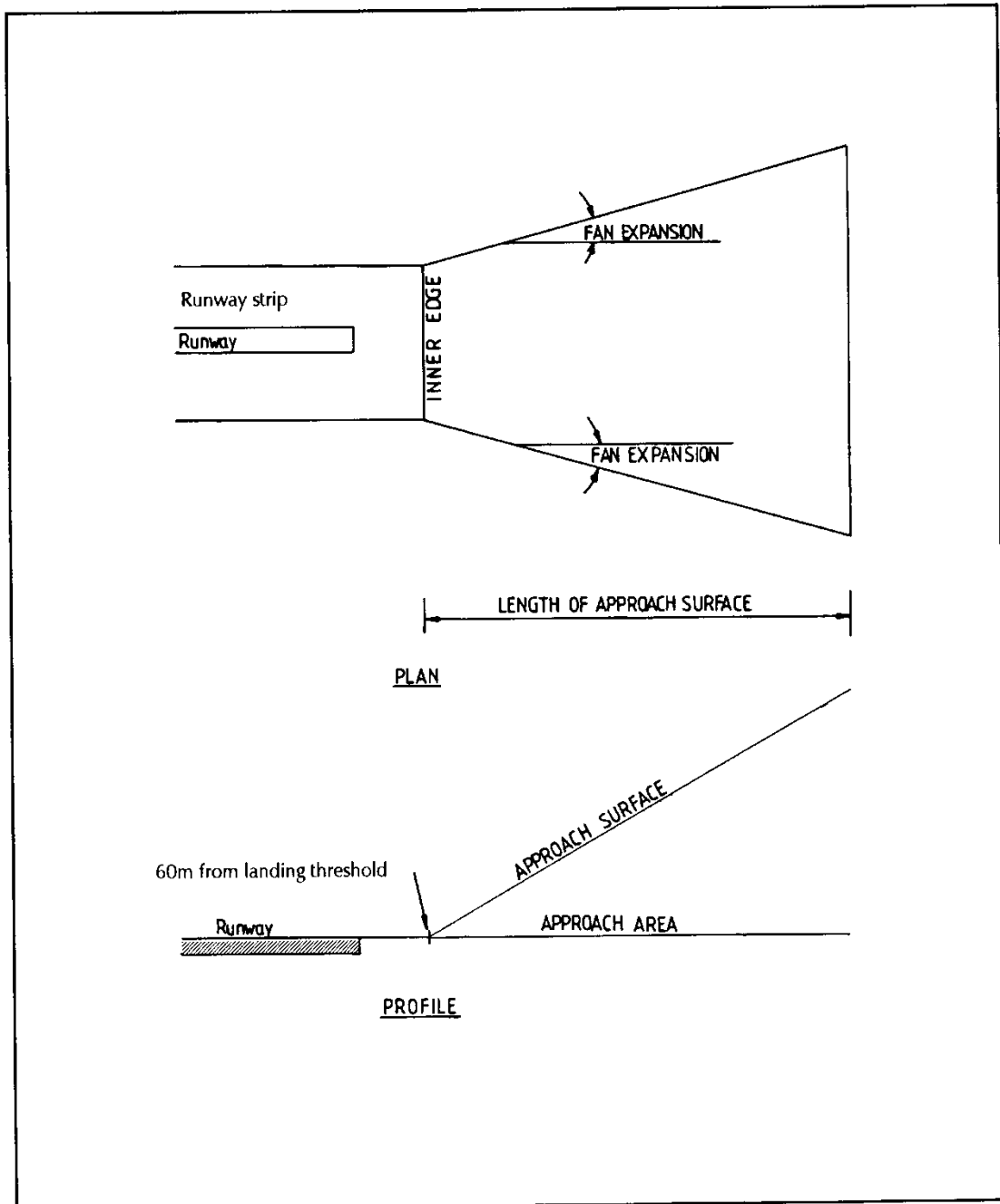

Figure 4-3. Approach area and surface

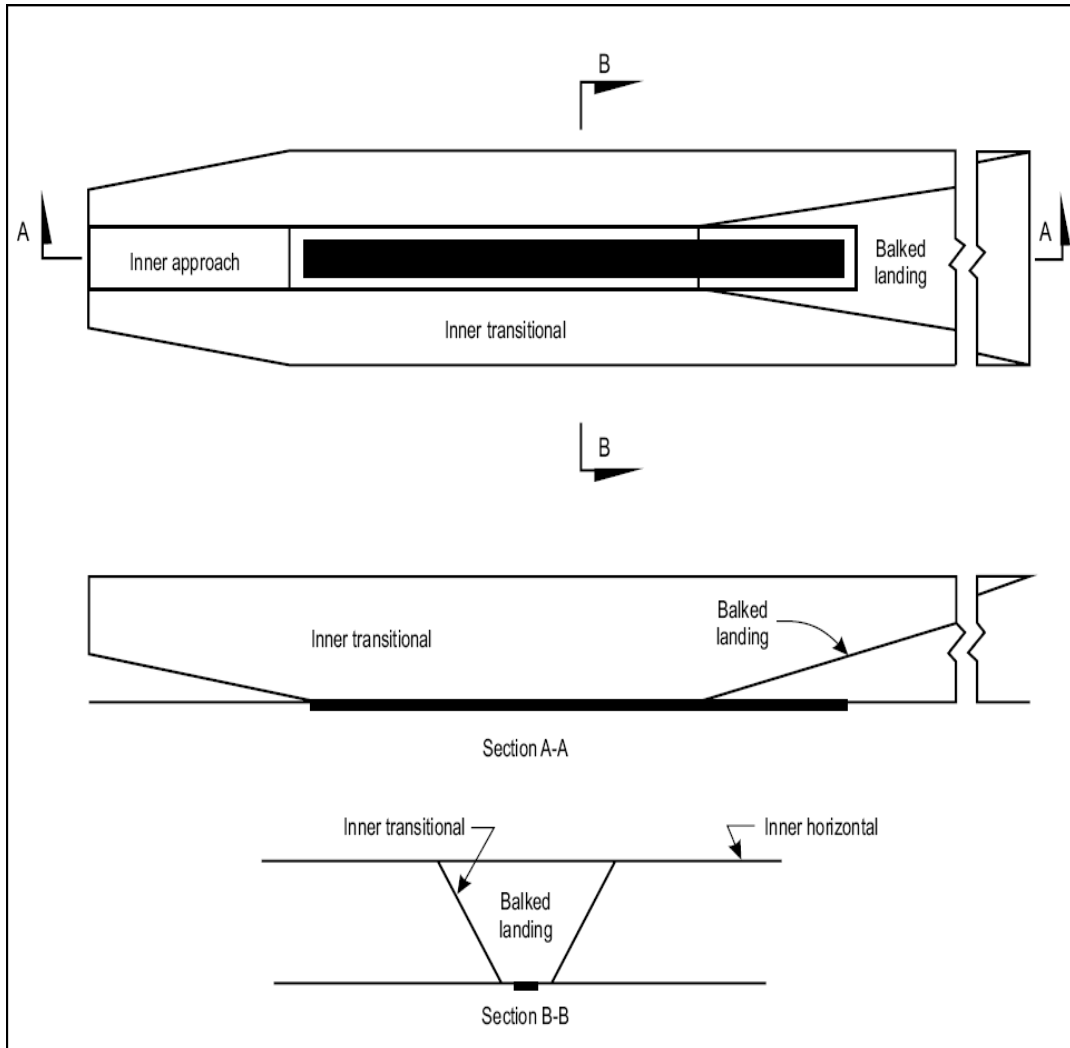

Figure 4-4. Inner approach, inner transitional and balked landing obstacle limitation surfaces

Table 4-1. Dimensions and slopes of obstacle limitation surfaces

Approach Runways

	Non-instrument				Non-precision approach			Precision approach category		
								I	II or III	
	Code Number				Code number			Code number	Code number	
Surface and dimensions	1	2	3	4	1,2	3	4	1,2	3,4	3,4
CONICAL Slope Height above aerodrome	1:20 150 m	1:20 150 m	1:20 150 m	1:20 150 m	1:20 150 m	1:20 150m	1:20 150 m	1:20 150 m	1:20 150 m	1:20 150 m
INNER HORIZONTAL Height above aerodrome Locus from strip edge	45 m 2000 m	45 m 2500 m	45 m 4000 m	45 m 4000 m	45 m 2500 m	45 m 4000 m	45 m 4000 m	45 m 3500 m	45 m 4000 m	45 m 4000 m
INNER APPROACH Width Distance from threshold Length Slope	— — — —	— — — —	— — — —	— — — —	— — — —	— — — —	— — — —	90 m 60 m 900 m 1:40	120 m ^e 60 m 900 m 1:50	120 m ^e 60 m 900 m 1:50
APPROACH Length of inner edge Distance from threshold Divergence (each side) Length Slope	60 m 30 m 1:10 1600 m 3000m ^h 1:20 1:40 ^h	80 m 60 m 1:10 2500 m 3000 m ^h 1:20 1:40 ^h	150 m ^f 60 m 1:10 3000 m 1:40 ^e	150 m ^f 60 m 1:10 3000 m 1:40 ^e	150 m 60 m 1:6.6 3000 m 1:40	150 m 60 m 1:6.6 15 000 m 1:40	150 m 60 m 1:6.6 15 000 m 1:40	150 m 60 m 1:6.6 15 000 m 1:40	300 m 60 m 1:6.6 15 000 m 1:50	300 m 60 m 1:6.6 15 000 m 1:50
TRANSITIONAL Slope	1:5	1:5	1:7	1:7	1:5	1:7	1:7	1:7	1:7	1:7
INNER TRANSITIONAL Slope	—	—	—	—	—	—	—	1:2.5	1:3	1:3
BALKED LANDING SURFACE Length of inner edge Distance from threshold Divergence (each side) Slope	— — — —	— — — —	— — — —	— — — —	— — — —	— — — —	— — — —	90 m c 1:10 1:25	120 m ^e 1800m ^d 1:10 1:30	120 m ^e 1800m ^d 1:10 1:30
<p>a. All dimensions are measured horizontally unless specified otherwise</p> <p>b. Applicable to International Aerodromes</p> <p>c. Distance to the end of the strip</p> <p>d. Or end of runway whichever is less</p> <p>e. Where the code letter is F, the width is increased to 155m</p> <p>f. For aircraft 5701 kg to 22700 kg MCTOW day only the width may be reduced to 90m.</p> <p>g. For aircraft 5701 kg to 22700 kg MCTOW day only the slope may be increased to 1:30.</p> <p>h. For an instrument runway or for night operations by aircraft with a MCTOW of 5700 kg or less.</p>										

— Take-off climb surface

Description

4.1.14 Each runway strip should be provided with a take-off climb surface such that aeroplanes taking off have a clear, obstacle-free path with a guaranteed clearance surface over which to climb. This climb path is located within a defined area called the take-off fan which originates from the end of the runway strip or the end of the clearway if one is declared. See Figure 4-5.

Characteristics

4.1.15 The fan is essentially a truncated triangle with the cut-off apex line called the inner edge. The length of this inner edge is specified in Table 4-2.

4.1.16 The expanding sides of the take-off fan diverge at a constant rate related to a percentage of the distance from the origin. This is called the fan expansion and extends to a specified distance from the origin. Refer Table 4-2.

4.1.17 The elevation of the inner edge should be equal to the greater of the following—

- (a) the highest ground level along the centre line between the runway end and the end of the strip or clearway, or
- (b) the highest point of the clearway plane.

4.1.18 In the case of a straight take-off flight path, the slope of the take-off climb surface should be measured in the vertical plane containing the centre line of the runway.

4.1.19 In the case of a take-off flight path involving a turn, the take-off climb surface should be a complex surface containing the horizontal normal to its centre line, and the slope of the centre line should be the same as that for a straight take-off flight path.

4.1.20 The obstacle free surface within a curved take-off fan should be achieved in such a manner as to allow a step down of 4.6 m (15 ft.) as shown in Figure 4-6. This step down is necessary to preserve obstruction clearance due to the performance degradation when the turn is greater than 15°.

The take-off fan may be turned in order to avoid obstacles which would otherwise penetrate the required take-off climb surface. A change of heading of less than 15° for obstacle clearance is not considered a curved flight path.

The expansion values as for a straight out surface apply in exactly the same manner for a curved take-off flight path. The percentage relates to the distance along the extended centre line as it proceeds throughout the turn from its origin at the end of the available take-off distance.

The radius of the turn for the curved extended centre line is to be related to the climb speeds of the aeroplanes which the runway is planned to serve.

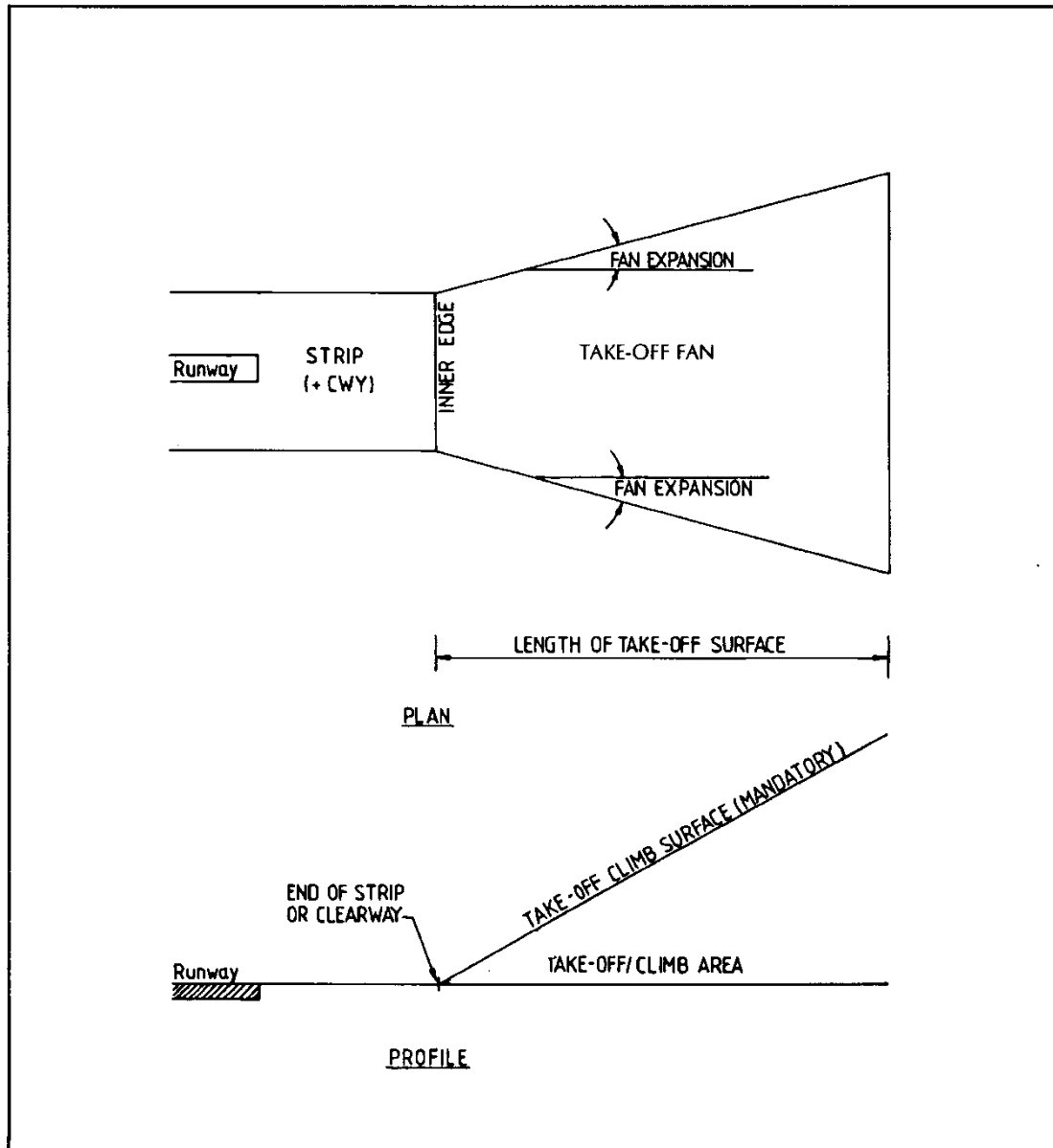

Figure 4-5. Take-off climb area and surface

4.2 Obstacle limitation requirements

The requirements for obstacle limitation surfaces are specified on the basis of the intended use of a runway, that is take-off or landing and type of approach, and are intended to be applied when such use is made of the runway. In cases where operations are conducted to or from both directions of a runway, then the function of certain surfaces may be nullified because of more stringent requirements of another lower surface.

— Approach runways

4.2.1 The following obstacle limitation surfaces should be established for a non-instrument approach runway:

- conical surface
- inner horizontal surface

- approach surface
- transitional surfaces.

4.2.2 The following obstacle limitation surfaces should be established for a non-precision approach runway:

- conical surface
- inner horizontal surface
- approach surface
- transitional surfaces.

4.2.3 The following obstacle limitation surfaces should be established for a precision approach runway Category I, II or III:

- conical surface
- inner horizontal surface
- approach surface and inner approach surface
- inner transitional and transitional surfaces
- balked landing surface.

4.2.3 The heights and slopes of the surfaces should not be greater than, and their other dimensions not less than, those specified in Table 4-1.

4.2.4 New objects or extensions of existing objects should not be permitted above an approach or transitional surface except when the new object or extension would be shielded by an existing immovable object.

4.2.5 New objects or extensions of existing objects should not be permitted above a conical surface or inner horizontal surface except when the object would be shielded by an existing immovable object, or an aeronautical study determines that the object would not adversely affect the safety or significantly affect the regularity of operations of aeroplanes.

Part 139, Appendix D.1—(c), (d) and (f), contain specific requirements for new objects or extensions of existing objects above an approach surface or a transitional surface of non-instrument, non-precision and precision approach runways.

Part 139, Appendix D.1—(e), permits certain frangible mounted objects to be located within the strip of a precision approach runway.

4.2.6 Existing objects, above any of the surfaces required by paragraphs 4.2.1 and 4.2.2, should as far as practicable be removed except when the object would be shielded by an existing immovable object, or an aeronautical study determines that the object would not adversely affect the safety or significantly affect the regularity of operations of aeroplanes.

Because of transverse or longitudinal slopes on a strip, in certain cases the inner edge or portions of the inner edge of the approach surface may be below the corresponding elevation of the strip. It is not intended that the strip be graded to conform with the inner

edge of the approach surface, nor is it intended that terrain or objects which are above the approach surface beyond the end of the strip, but below the level of the strip, be removed unless it is considered they may endanger aeroplanes.

4.2.7 In considering proposed construction, account should be taken of the possible future development of the runway and possible requirement for more stringent obstacle limitation surfaces.

— **Take-off runways**

4.2.8 A take-off climb surface should be established for a take-off runway.

4.2.9 The dimensions of the surface should not be less than the dimensions specified in Table 4-2, except that a lesser length may be adopted for the take-off climb surface where such a lesser length would be consistent with procedural methods adopted to govern the outward flight of aeroplanes.

4.2.10 The operational characteristics of aeroplanes for which the runway is intended should be examined to see if it is desirable to reduce the slope specified in Table 4-2 when critical operating conditions are to be catered for.

If the specified slope is reduced, corresponding adjustment in length of the take-off climb surface should be made so as to provide protection to a height of 300 m.

4.2.11 New objects or extensions of existing objects should not be permitted above a take-off climb surface except when the new object or extension would be shielded by an existing immovable object.

4.2.12 If no object reaches the 2% (1:50) take-off climb surface, new objects should be limited to preserve the existing obstacle free surface or a surface down to a slope of 1.6% (1:62.5).

Part 139, Appendix D.2, contains requirements for new objects or extensions of existing objects above a take-off climb surface.

4.2.13 New objects or extensions of existing objects are not permitted above a take-off climb surface except when the new object or extension is shielded by an existing immovable object, or an aeronautical study determines that the object will not adversely affect the safety or significantly affect the regularity of operations of aircraft.

Table 4-2. Dimensions and slopes of obstacle limitation surfaces**TAKE-OFF RUNWAYS**

Surface and dimensions	Code number			ACFT 5701 kg to 22700 kg MCTOW Day use only	
	1	2	3 or 4	3 or 4	
TAKE-OFF CLIMB					
Length of inner edge	60 m	80 m	150 m ^f	90 m	
Distance from runway end ^b	10 m	30 m	60 m ^b	60 m	
Divergence (each side)	1:10	1:10	1:8	1:8	
Final width	380 m	580 m	1 200 m 1 800 m ^c	1200 m	
Length	1600 m 3000 m ^e	2500 m 3000 m ^e	15 000 m	15000 m	
Slope	1:20 1:40 ^e	1:20 1:40 ^e	1:50 ^{de}	1:40	

- a. All dimensions are measured horizontally unless specified otherwise
- b. The take-off climb surface starts at the end of the clearway if the clearway length exceeds the specified distance.
- c. 1800m when the intended track includes changes of heading greater than 15° for operations conducted in IMC, VMC by night.
- d. See paragraphs 4.2.10 and 4.2.12.
- e. For day time only take-off runways used by non turbo-jet aircraft on domestic operations this may be reduced to 1:40
- f. 180 m for instrument runways at international aerodromes
- g. For an instrument runway or for night operations by aircraft with a MCTOW of 5700 kg or less.

Note: Operators of domestic aerodromes should be aware that it is highly probable that the use of GPS will be approved to precision approach Category 1 minima. Should you want this capability for your aerodrome, you should plan on achieving those dimensions and slopes specified in Table 4-1 for precision approach runways.

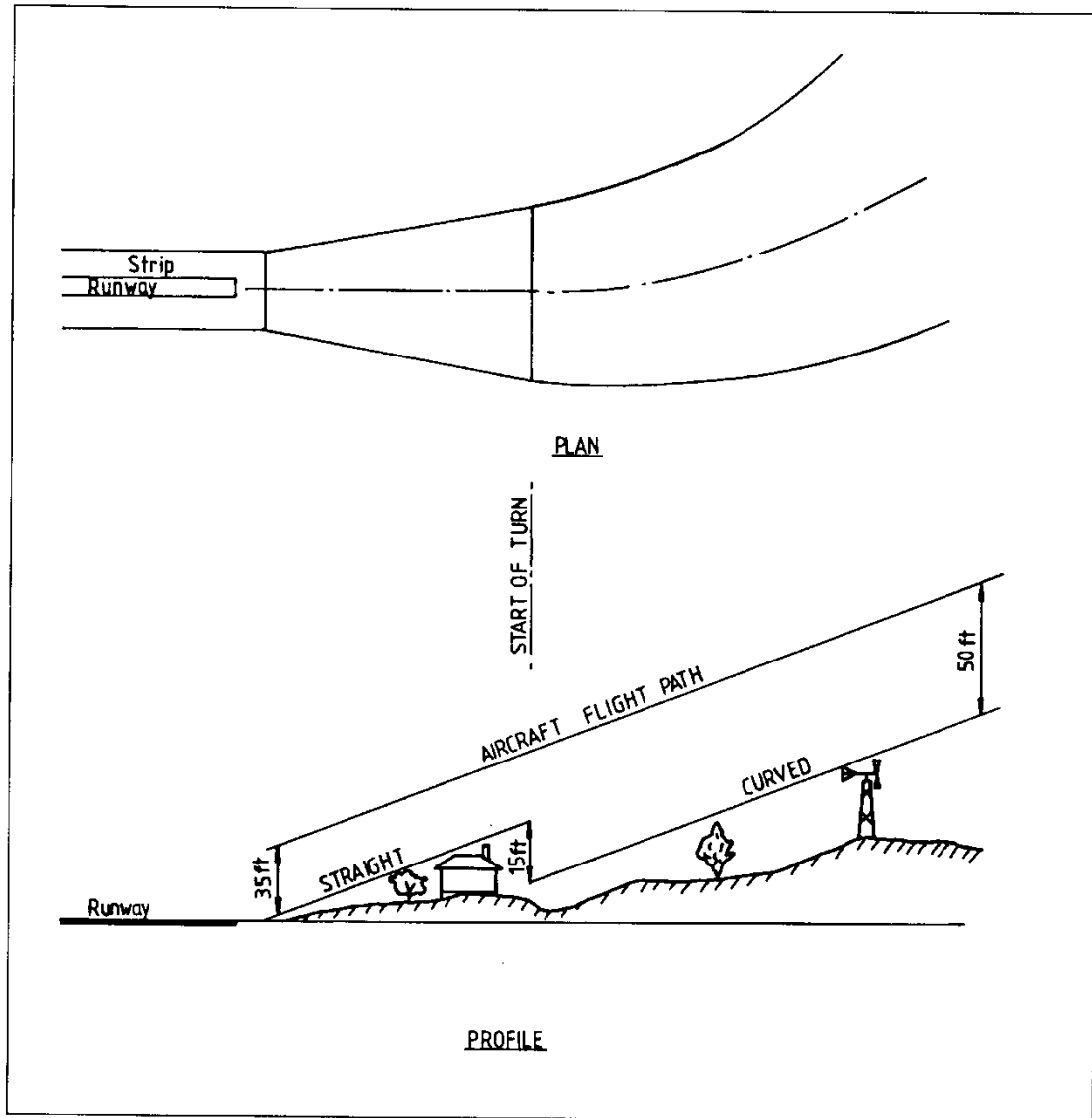

Figure 4-6. Turned take-off flight path

Conversion factors					
1:83.3	1.2%	0°41'16"	1:20	5%	2°51'44"
1:62.5	1.6	0°55'00"	1:10	10%	5°42'38"
1:50	2%	1°08'45"	1:8	12.5%	7°07'30"
1:40	2.5%	1°25'56"	1:7	14.3%	8°07'48"
1:30	3.33%	1°54'33"	1:6.6	15.0%	8°31'51"
1:25	4%	2°17'26"	1:5	20%	11°18'36"

4.3 Other objects

4.3.1 Objects which do not project through the approach surface but which nevertheless adversely affect the optimum siting or performance of visual or non-visual aids should, as far as practicable, be removed.

4.3.2 Anything which endangers aeroplanes on the movement area or in the air within the limits of the inner horizontal and conical surfaces should be regarded as an obstacle and should be removed so far as practicable.

4.4 Shielding

4.4.1 An object should be considered shielded if it is lower and behind an object which is already considered to be a hazard to air navigation and has been marked by standard obstacle marking or lighting, or both.

4.4.2 The permanency of immovable obstacle which is to be considered as shielding an area should be given careful review. An object should be classed as immovable only if, when taking the longest view possible, there is no prospect of removal being practicable, possible or justifiable, regardless of how the pattern, type or density of air operations might change.

4.4.3 Where the obstacle to be shielded penetrates a take-off or approach surface, a transitional surface or an inner horizontal surface, it should meet the requirements shown in Figures 4-7 and 4-8 in relation to a horizontal surface from the marked object. An obstacle not penetrating these surfaces may be considered shielded if located within 600 m (2000 ft) of the marked obstacle.

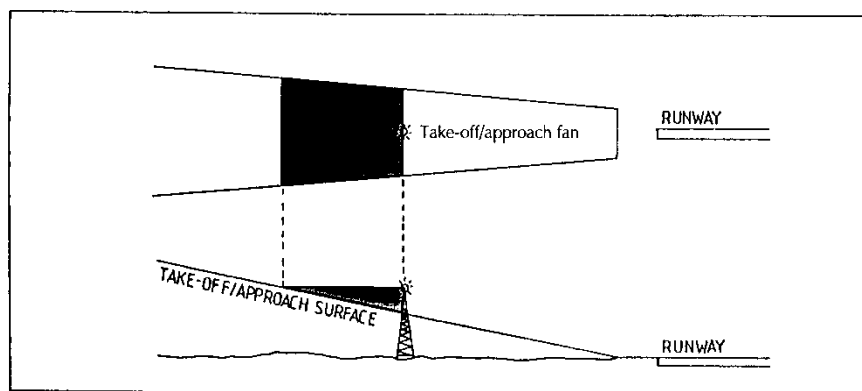

Figure 4-7. Shielding – approach and take-off surfaces

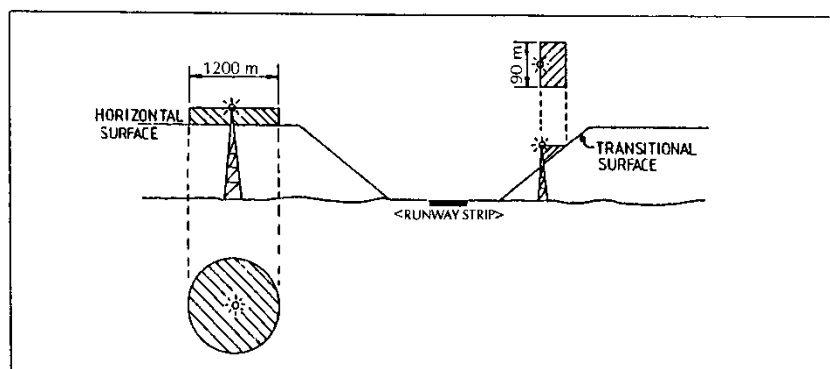

Figure 4-8. Shielding – transitional and horizontal surface

5. VISUAL AIDS FOR NAVIGATION

5.1 Indicators

— Wind direction indicators

The rule requirements for wind direction indicators are contained in Part 139, Appendix E.1.

Application

5.1.1 A wind direction indicator (windsock) should be located on the left hand side of each runway or strip threshold.

Location

5.1.2 A windsock should be located abeam the landing threshold at each end of the runway so as to be visible from aircraft in flight or on the movement area and in such a way as to be free from the effects of air disturbances caused by nearby objects. It should also be clear of the obstacle free surfaces for that runway.

Characteristics

5.1.3 The windsock should be in the form of a truncated cone made of fabric and should have a length of not less than 3.6 m and a diameter, at the larger end, of not less than 0.9 m. It should be coloured light orange or white and constructed so that it gives a clear indication of the direction of surface wind and a general indication of wind speed when seen from a height of 300 m (1000 ft).

5.2 Markings

The rule requirements for wind direction indicators are contained in Part 139, Appendix E.2.

— General

5.2.1 Runway, taxiway and apron markings are essential for the safe and efficient use of aerodromes, and their effectiveness is dependent upon proper maintenance to maintain an acceptable level of conspicuousness. The marking elements for each paved runway classification may contain additional elements normally used on a higher runway classification but should never be less than the following.

(a) Precision approach runway:

- (i) centre line markings
- (ii) designation markings
- (iii) threshold markings
- (iv) fixed distance markings
- (v) touchdown zone markings
- (vi) taxi-holding position markings.

(b) Instrument approach runway:

- (i) centre line markings
- (ii) designation markings
- (iii) threshold markings

- (iv) fixed distance markings (on runways 1200 m or longer used by jet aircraft)
- (v) taxi-holding position markings.

(c) Non instrument runway:

- (i) centre line markings
- (ii) designation markings
- (iii) threshold markings
- (iv) fixed distance marking (on runways 1200 m or longer used by jet aircraft)
- (v) taxi-holding position markings.

(d) Runways less than 1200 m long:

- (i) designation markings
- (ii) threshold markings.

— **Interruption of runway markings**

The rule requirements for interruption of runway markings are contained in Part 139, Appendix E.2.3.

5.2.2 Where two or more runways intersect, the markings on the more important runway, except for the runway side stripe marking, must be displayed and the markings of the other runway(s) must be interrupted. The runway side stripe marking of the more important runway may either be continued across the intersection or interrupted. If necessary, the runway threshold marking, designation marking and touchdown zone markings should be relocated along the lower precedence runway to avoid the intersection area.

5.2.3 For intersection of runways of the same importance, the preferred runway (lowest approach minimum's or most often used) is considered to be the more important. For marking purposes, the order of importance, is:

- 1st - precision approach runways
- 2nd - instrument approach runways
- 3rd - non-instrument approach runway.

— **Colour**

The rule requirements colour is contained in Part 139, Appendix E.2.1.

5.2.5 Runway markings must be white.

On runway surfaces of light colour, the conspicuity of white markings can be improved by outlining them in black.

Where operations take place at night, pavement markings should be made with reflective materials designed to enhance the visibility of the markings.

It is preferable that the risk of uneven friction characteristics on markings be reduced in so far as practicable by the use of a suitable kind of paint.

Markings may consist of solid areas or a series of longitudinal stripes providing it gives an appearance equivalent to the solid areas.

5.2.6 Taxiway markings and aircraft stand markings must be yellow.

5.2.7 Apron safety lines should be of a conspicuous colour which should contrast with that used for aircraft stand markings.

— **Unpaved taxiways**

5.2.8 An unpaved taxiway should be provided with edge markings, boundary markers, cones or some such suitable markers whenever the delineation of the taxiway edge is not made obvious by surface texture, colour or other means.

— **Runway designation marking**

Application

5.2.9 A runway designation marking should be provided:

- at the thresholds of a paved runway
- as far as practicable at the thresholds of an unpaved runway.

Location

5.2.10 Runway numbers should be located at a threshold when viewed from the direction of approach and located in accordance with Figure 5-1. For an unpaved runway where it is difficult to mark the runway surface, options include using a marker board (or similar) including the runway designator, or a concrete pad with the designator or concrete numbers embedded in the grass runway before or adjacent to the threshold.

Characteristics

5.2.11 Runway numbers should consist of two digits and should be a whole number nearest to one tenth of the magnetic bearing of the centre line of the runway when viewed from the direction of approach.

5.2.12 Where the bearing of the runway is $xx5^\circ$, such as 135° , the number allocated should be the next larger number that is 14.

5.2.13 For parallel runways the runway designation should be as follows.

- On parallel runways of the same physical surface the number should be supplemented by a letter L, C or R, preceding it longitudinally to designate left, centre or right runway.
- Parallel runways that clearly have different physical surfaces do not need to use the “L” or “R” letter supplement e.g. paved and grass or paved and pumice surface.

5.2.14 Runway numbers should conform to the shape and dimensions shown in Figure 5-2.

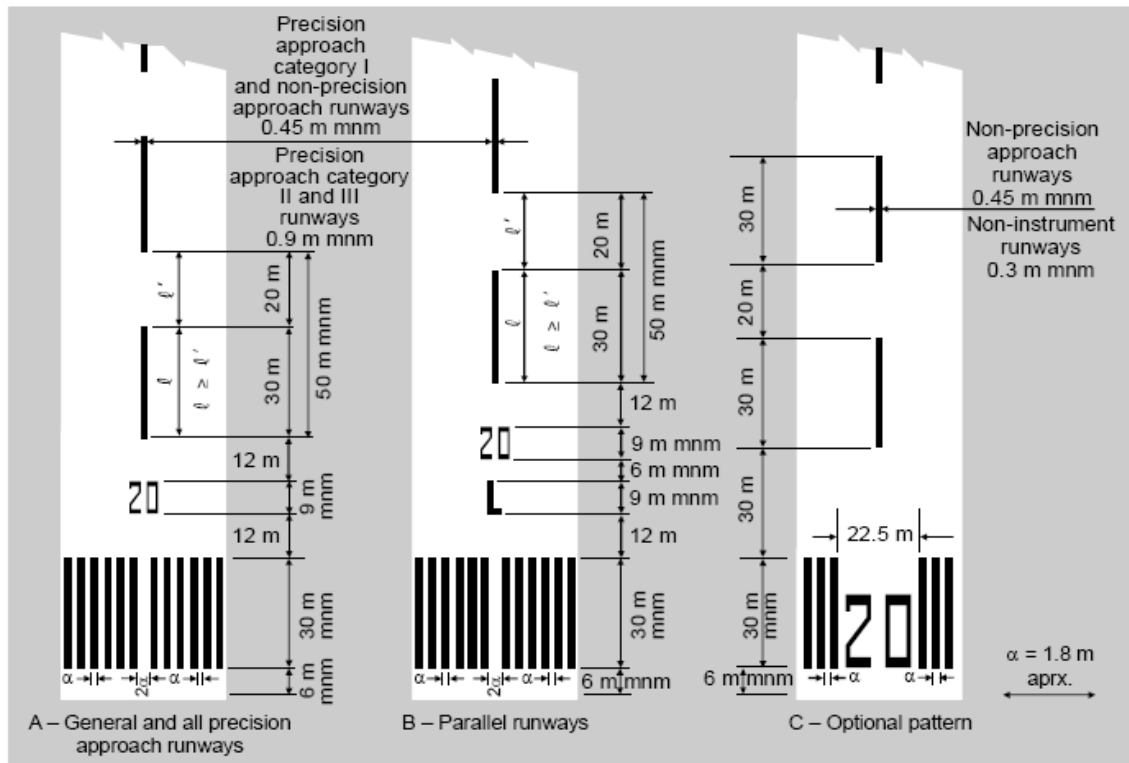

Figure 5-1. Runway designation, centre line and threshold markings

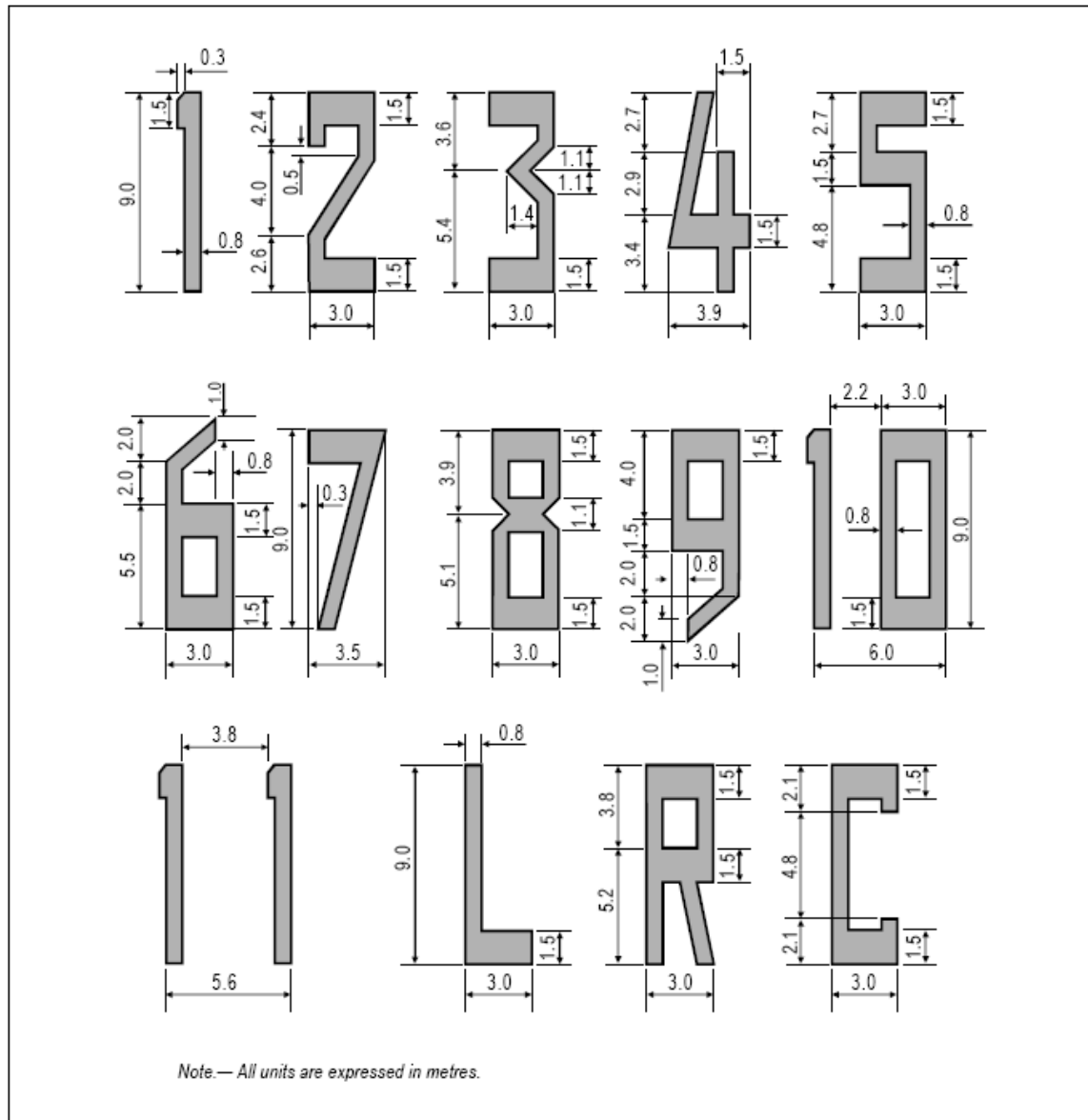

Figure 5-2. Forms and proportion of numbers and letters for runway designation markings

— **Runway centre line marking**

Application

5.2.15 Runway centre line markings should be provided on all paved runways.

Location

5.2.16 Centre line markings should be located along the centre of the runway between the runway designation markings as shown in Figure 5-1 except when interrupted in compliance with 5.2.2 and 5.2.3.

Characteristics

5.2.17 Runway centre line markings should consist of a series of uniformly spaced stripes and gaps. The length of the stripe plus gap should be not less than 50 m or greater than 75 m. The length of each stripe should be at least equal to the length of the gap or 30 m, whichever is greater.

5.2.18 The width of the stripe should not be less than:

- 0.9 m on precision approach category II and III runways
- 0.45 m on precision approach category I runways, and non-precision approach runways where the code number is 3 or 4
- 0.3 m for a non-precision approach runways where the code number is 1 or 2, and on non-instrument runways.

— **Threshold marking**

Application

5.2.19 Threshold markings should be provided at the threshold of a runway.

Location

5.2.20 The stripes of the threshold markings should commence 6 m from the threshold.

Characteristics

5.2.21 The threshold markings should consist of a pattern of longitudinal stripes of uniform dimensions disposed symmetrically about the centre line of the runway as shown in Figure 5-1(A) and (B).

5.2.22 The number of stripes should be in accordance with the runway width as follows—

Runway width	Number of stripes
18 m	4
23 m	6
30 m	8
45 m	12
60 m	16

Except that on non-precision approach and non-instrument runways 45 m or greater in width, they may be as shown in Figure 5-1(C).

Transverse stripe

The rule requirements for a transverse stripe are contained in Part 139, Appendix E.2.4.

5.2.23 Where a threshold is displaced from the extremity of the runway or where the extremity of the runway is not square with the runway centre line, then a transverse stripe must be added to the threshold marking.

5.2.24 A transverse stripe should not be less than 1.8 m wide.

5.2.25 A transverse stripe, where required, should be located at the threshold of the runway. The edge furthest from the threshold markings should coincide with the position of the threshold.

Arrows

The rule requirements for arrows are contained in Part 139, Appendix E.2.5).

5.2.26 Where a runway threshold is permanently displaced, arrows conforming to those shown in Figure 5-3 (B) must be provided on the portion of the runway before the displaced threshold.

5.2.27 When a runway threshold is temporarily displaced from the normal position, it should be marked as shown in Figure 5-3 (A) or Figure 5-3 (B) and all markings prior to the displaced threshold should be obscured except the runway centre line markings, which should be converted to arrows.

Where the threshold is to be displaced for only a short period of time it is satisfactory to use markers in the form and colour of wing bars of cones or marker boards outside the runway edge.

When the runway before a displaced threshold is unfit for the surface movement of aircraft, closed markings, as described in paragraph 7.1.4, are required to be provided.

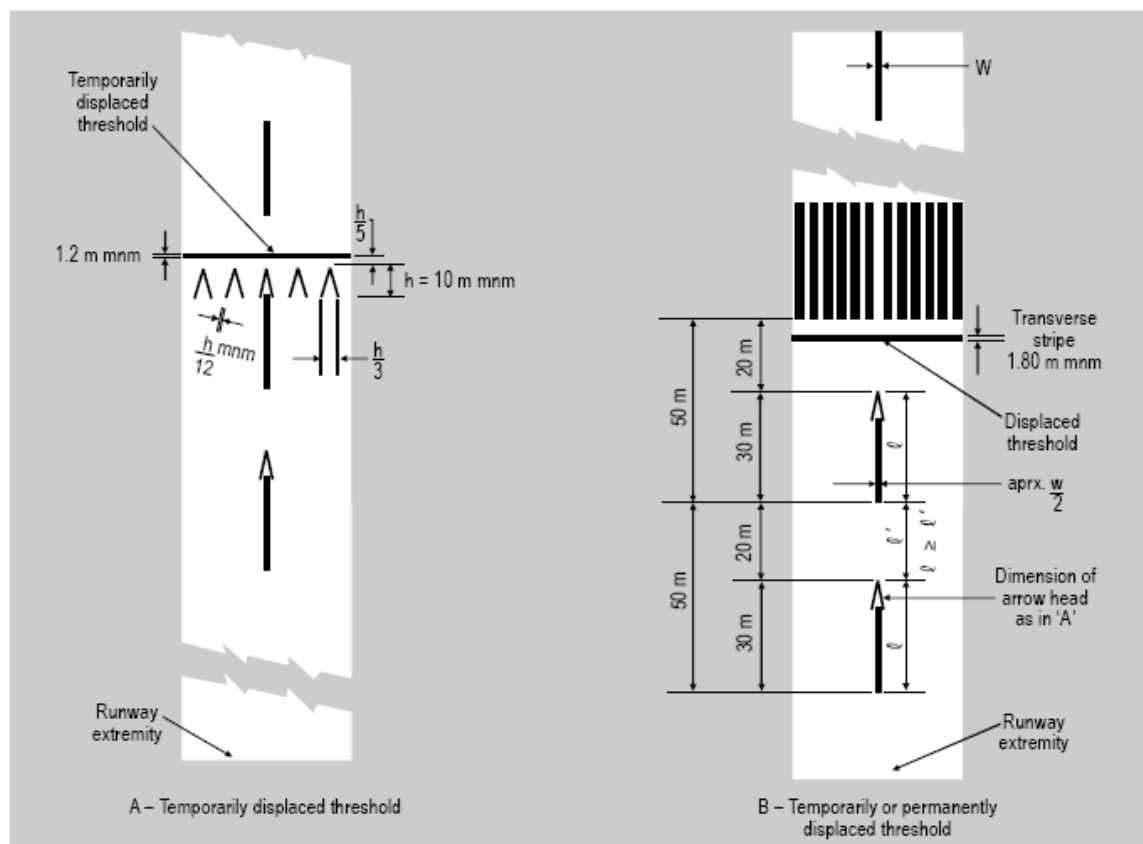

Figure 5-3. Displaced threshold markings

— **Aiming point marking**

The rule requirements for aiming points on paved instrument runways where the aerodrome reference code number is 2, 3 or 4 are contained in Part 139, Appendix E.2.6.

Application

5.2.28 Aiming point markings must be provided at each approach end of a paved instrument runway where the code number is 2, 3 or 4. An aiming point marking should also be provided at each approach end of a paved non-instrument runway where the code number is 3 or 4, and a paved instrument runway where the code number is 1, when additional conspicuity of the aiming point is desirable.

Location

5.2.29 The aiming point markings should commence no closer to the threshold than the distance in the appropriate column of Table 5-1, except that, on a runway equipped with a visual approach slope indicator system, the beginning of the marking should be coincident with the visual approach slope origin.

Characteristics

5.2.30 An aiming point marking should consist of two conspicuous stripes. The dimensions of the stripes and the lateral spacing between their inner sides should be in accordance with the appropriate column of Table 5-1. Where a touchdown zone marking is provided, the lateral spacing between the markings should be the same as that of the touchdown zone marking.

5.2.31 To provide maximum skid resistance the rectangular marking may consist of a series of stripes.

Note: *Aerodromes that have visual approach slope indicator systems and the aiming point marking is located at a fixed distance of 300 m from the threshold will not be required to relocate the marking until the runway is remarked.*

Table 5-1. Location and dimensions of aiming point marking

Location and dimensions (1)	Landing distance available			
	Less than 800 m (2)	800 m up to but not including 1200 m (3)	1200 m up to but not including 2400 m (4)	2400 m and above (5)
Distance from threshold to beginning of marking	150 m	250 m	300 m	400 m
Length of stripe ^a	30-45 m	30-45 m	45-60 m	45-60 m
Width of stripe	4 m	6 m	6-10 m ^b	6-10 m ^b
Lateral spacing between inner sides of stripes	6 m ^c	9 m ^c	18-22.5 m	18-22.5 m

- (a) The greater dimensions of the specified ranges are intended to be used where increased conspicuity is required.
- (b) The lateral spacing may be varied within these limits to minimise the contamination of the marking by rubber deposits.

- (c) These figures were deduced by reference to the outer main gear wheel span which is element 2 of the aerodrome reference code.

— **Touchdown zone marking**

The rule requirements for touchdown zone marking on paved precision approach runways where the aerodrome reference code number is 2, 3 or 4 are contained in Part 139, Appendix E.2.7.

Application

5.2.32 Touchdown zone markings must be provided in the touchdown zone of a paved precision approach runway where the code number is 2, 3 or 4, and a paved non-precision approach or non-instrument approach runway where the code number is 3 or 4 and additional conspicuity of the touchdown zone is desirable.

Location and characteristics

5.2.33 A touchdown zone marking should consist of pairs of rectangular markings symmetrically disposed about the runway centre line with the number of such pairs related to the landing distance available and, where the marking is to be displayed at both the approach directions of a runway, the distance between the thresholds, as follows—

Landing distance available or the distance between thresholds	Pair(s) of markings
Less than 900 m	1
900 m up to but not including 1200 m	2
1200 m up to but not including 1500 m	3
1500 m up to but not including 2400 m	4
2400 m or more	6

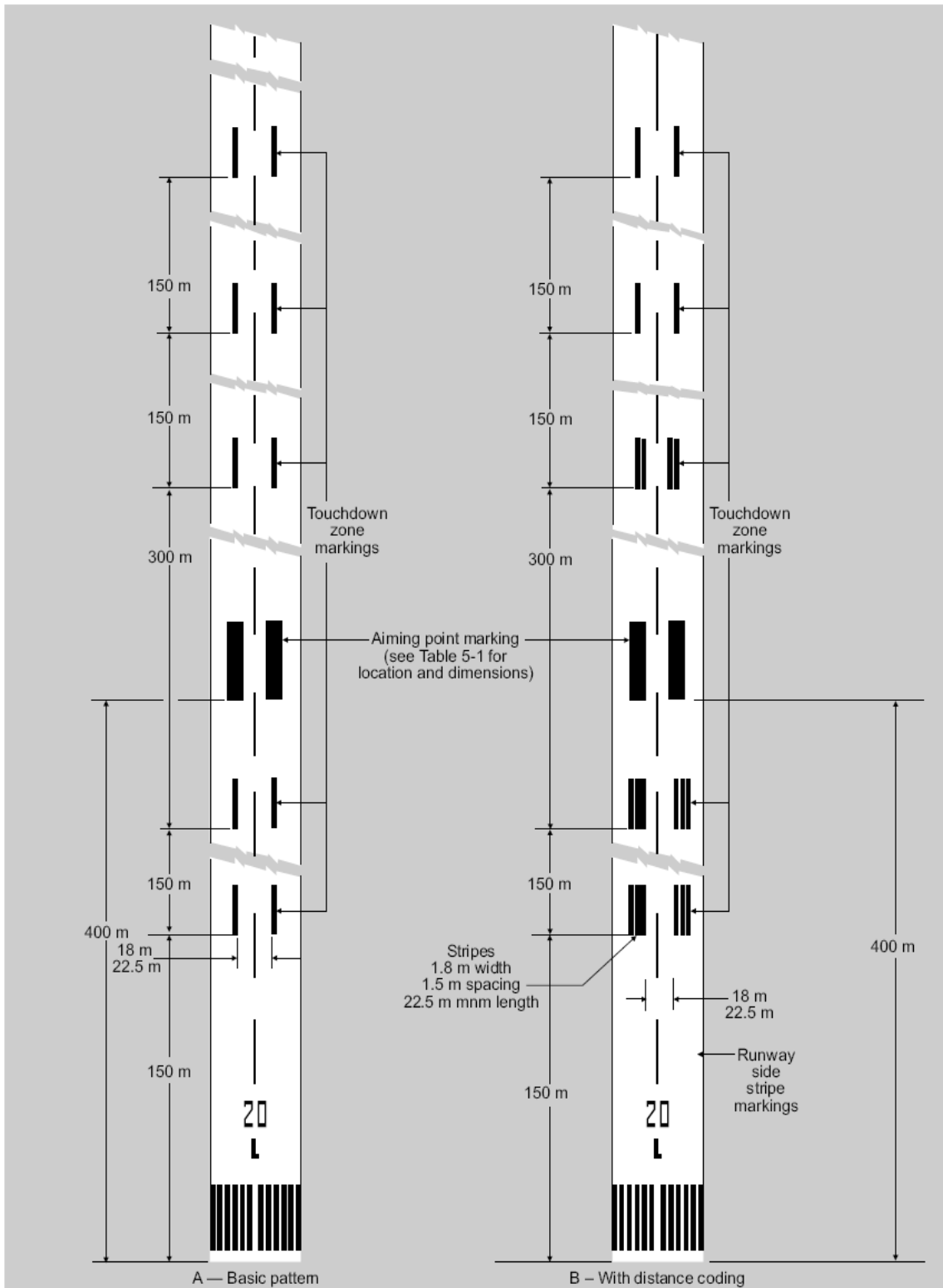

Figure 5-4. Aiming point and touchdown zone markings (illustrated for runway with a length of 2400 m or more)

5.2.34 A touchdown zone marking should conform to either of the two patterns shown in Figure 5-4. For the pattern shown in Figure 5-4 (A), the markings should not be less than 22.5 m long and 3 m wide. For the pattern shown in Figure 5-4 (B), each stripe of each marking should not be less than 22.5 m long and 1.8 m wide with a spacing of 1.5 m between adjacent stripes. The lateral spacing between the inner sides of the rectangles should be equal to that of the

aiming point marking where provided. Where an aiming point marking is not provided, the lateral spacing between the inner sides of the rectangles should correspond to the lateral spacing specified for the aiming point marking in Table 5-1 (columns 2, 3, 4 or 5, as appropriate). The pairs of markings should be provided at longitudinal spacing's of 150 m beginning from the threshold except that pairs of touchdown markings coincident with or located within 50 m of an aiming point marking should be deleted from the pattern.

5.2.35 On a non-precision approach runway where the code number is 2, an additional pair of touchdown zone marking stripes should be provided 150 m beyond the beginning of the aiming point marking.

— **Runway touchdown zone limit marking**

Application

5.2.36 Touchdown zone limit markings define the limit of the touchdown zone area for specific aircraft operations. They should be provided when the runway available is severely restrictive for a particular aircraft type.

Location

5.2.37 The location of the touchdown zone limit marking should be determined in conjunction with the aircraft operator concerned.

Characteristics

5.2.38 The touchdown zone marking should consist of a series of transverse stripes formed as a right angle triangle on each side of the runway as shown in Figure 5-5.

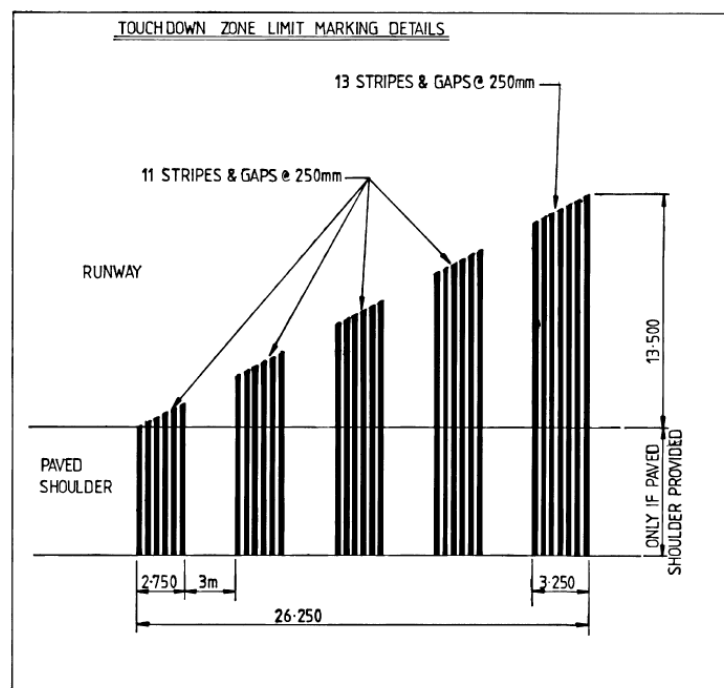

Figure 5-5. Touchdown zone limit marking

— **Runway side stripe marking**

The rule requirements for runway side stripe markings are contained in Part 139, Appendix E.2.8.

Application

5.2.39 Runway side stripe markings must be provided between the thresholds of a paved runway where there is a lack of contrast between the runway edges and the shoulders or the surrounding terrain.

Location

5.2.40 A runway side stripe marking should consist of two stripes, one placed along each side of the runway with the outer edge of each stripe approximately along the edge of the runway, except that, where the runway is greater than 60 m in width, the stripes should be located 30 m from the runway centre line.

Characteristics

5.2.41 The side stripe marking should have a width of at least 0.9 m on runways 30 m or greater in width. On other runways the width should be equal to the width of the runway centre line marking.

— Taxiway centre line marking

The rule requirements for taxiway centre line markings are contained in Part 139, Appendix E.2.9.

Application

5.2.42 Taxiway centre line marking must be provided on a paved taxiway, de-icing/anti-icing facility and apron in such a way as to provide guidance from the runway centre line to the point on the apron where aircraft stand markings commence.

5.2.43 Taxiway centre line marking must be provided on a paved runway when the runway is part of a standard taxi route and:

- there is no runway centre line marking;
- where the taxiway centre line is not coincident with the runway centre line.

5.2.44 Where it is necessary to denote the proximity of a runway-holding position, enhanced taxiway centre line marking should be provided.

The provision of enhanced taxiway centre line marking may form part of runway incursion preventative measures.

5.2.45 Where provided, enhanced taxiway centre line marking should be installed at all taxiway/runway intersections at that aerodrome.

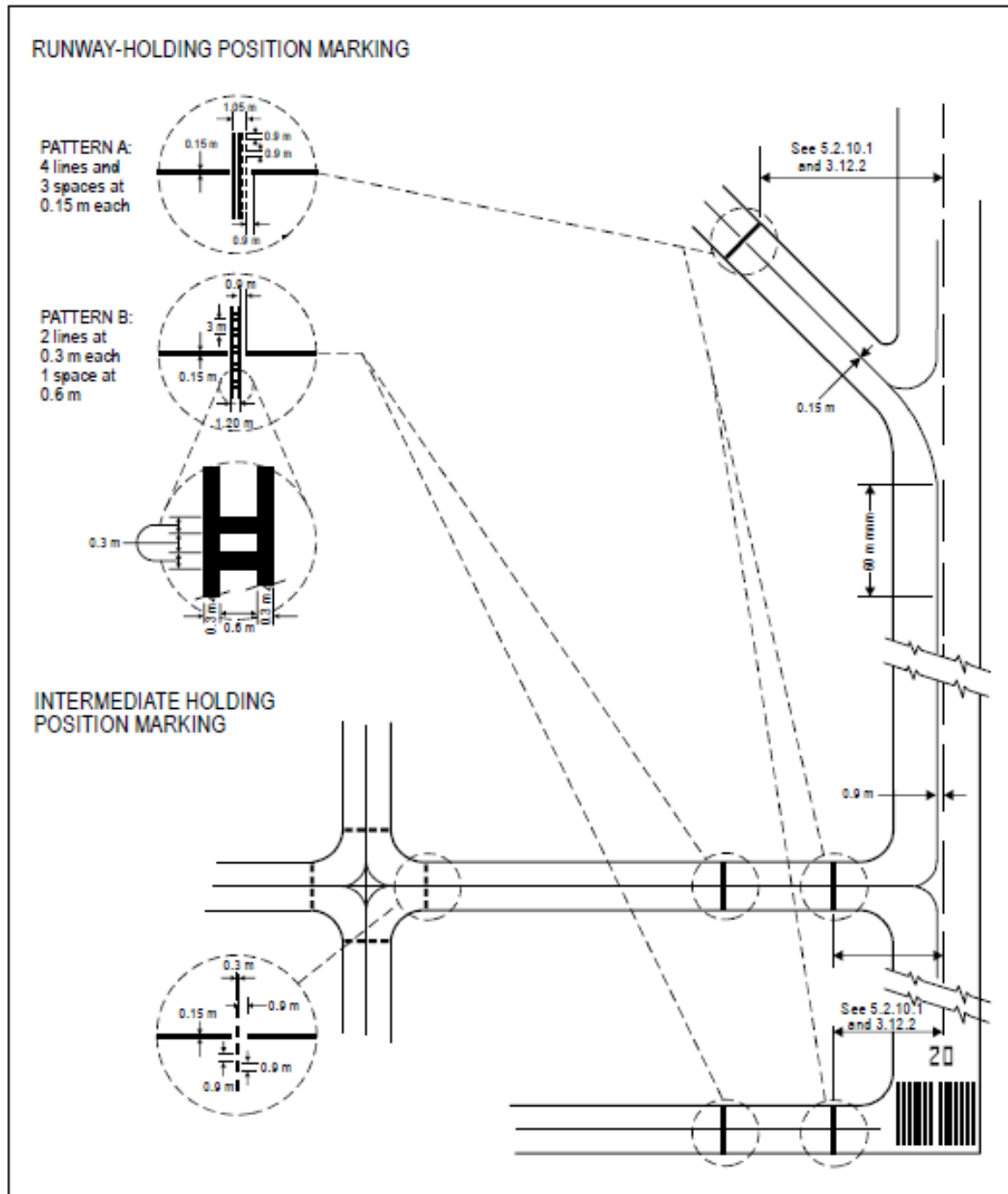

**Figure 5-6. Taxiway markings
(shown with basic runway markings)**

Location

5.2.46 On a straight portion of taxiway the centre line marking should be located along the centre line of the taxiway. On a taxiway curve the marking should continue from the straight portion of the taxiway at a constant distance from the outside edge of the curve until it joins the centre line of the next straight portion of taxiway.

5.2.47 At an intersection of a taxiway with a runway where the taxiway serves as an exit from the runway, the taxiway centre line marking should be curved into the runway centre line marking as shown in Figure 5-6. The taxiway centre line marking should be extended parallel to the

runway centre line marking for a distance of at least 60 m beyond the point of tangency where the code number is 3 or 4, and for a distance of at least 30 m where the code number is 1 or 2.

5.2.48 Where taxiway centre line marking is provided on a runway in accordance with 5.2.43, the marking should be located on the centre line of the designated taxiway.

5.2.49 Where provided, an enhanced taxiway centre line marking should extend from the runway-holding position pattern A (as defined in Figure 5-6) to a distance of up to 45 m (a minimum of three (3) dashed lines) in the direction of travel away from the runway or to the next runway-holding position, if within 45 m distance.

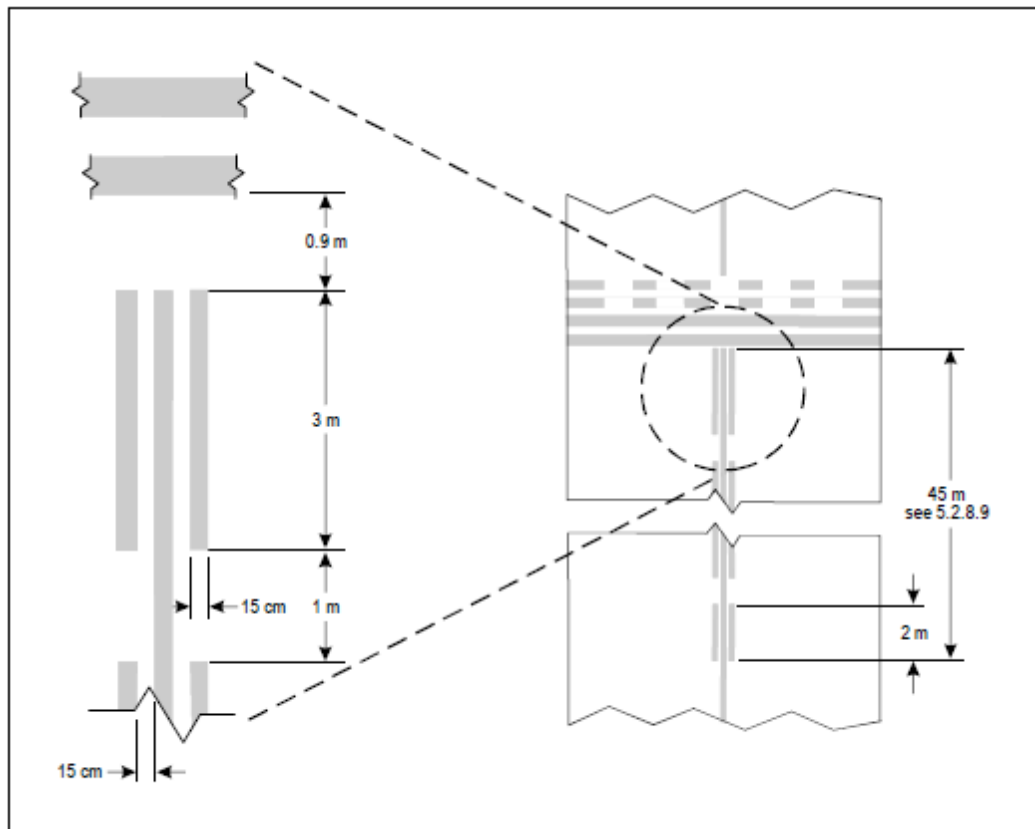

Figure 5-7. Enhanced taxiway centre line marking

Characteristics

5.2.50 A taxiway centre line marking should be a continuous yellow line 150 mm wide except where it intersects a taxi-holding position marking as shown in Figure 5-6.

5.2.51 Enhanced taxiway centre line marking should be as shown in Figure 5-7.

— Runway turn pad marking

The rule requirements for runway turn pad markings are contained in Part 139, Appendix E.2.10.

Application

5.2.52 Where a runway turn pad is provided, a runway turn pad marking must be provided for continuous guidance to enable an aeroplane to complete a 180° turn and align with the runway centre line.

Location

5.2.53 The runway turn pad marking should be curved from the runway centre line into the turn pad.

The radius of the curve should be compatible with the manoeuvring capability and normal taxiing speeds of the aeroplanes for which the runway turn pad is intended. The intersection angle of the runway turn pad marking with the runway centre line should not be greater than 30°.

5.2.54 The runway turn pad marking should be extended parallel to the runway centre line marking for a distance of at least 60 m beyond the point of tangency where the code number is 3 or 4, and for a distance of at least 30 m where the code number is 1 or 2.

5.2.55 A runway turn pad marking should guide the aeroplane in such a way as to allow a straight portion of taxiing before the point where a 180° turn is to be made. The straight portion of the runway turn pad marking should be parallel to the outer edge of the runway turn pad.

5.2.56 The design of the curve allowing the aeroplane to negotiate a 180° turn should be based on a nose wheel steering angle not exceeding 45°.

5.2.57 The design of the turn pad marking should be such that, when the cockpit of the aeroplane remains over the runway turn pad marking, the clearance distance between any wheel of the aeroplane landing gear and the edge of the runway turn pad should be not less than those specified in paragraph 3.4.5.

Note: For ease of manoeuvring, consideration may be given to providing a larger wheel-to-edge clearance for codes E and F aeroplanes. See paragraph 3.4.6.

Characteristics

5.2.58 A runway turn pad marking should be at least 15 cm in width and continuous in length. In normal circumstances the colour used should be yellow.

— Runway-holding position marking

The rule requirements for runway holding position markings are contained in Part 139, Appendix E.2.11.

Application

5.2.59 Runway-holding position markings must be provided on all paved taxiways adjacent to the junction of a runway. On unpaved taxiways, marker boards or cones should be used to define the location of the runway-holding position.

Location

5.2.60 Runway-holding position markings must be displayed along a runway-holding position. See subsection 3.12 and Table 3-2.

Characteristics

5.2.61 Runway-holding position markings should be as shown in Figure 5-6 for standard markings and as Figure 5.8 when enhanced markings are required.

— **Intermediate holding position marking**

Application

5.2.62 Intermediate holding position markings should be displayed along an intermediate holding position.

Location

5.2.63 Where an intermediate holding position marking is displayed at an intersection of two paved taxiways, it should be located across the taxiway at sufficient distance from the near edge of the intersecting taxiway to ensure safe clearance between taxiing aircraft. It should be coincident with a stop bar or intermediate holding position lights, where provided.

Characteristics

5.2.64 An intermediate holding position marking should consist of a single broken line as shown in Figure 5-6.

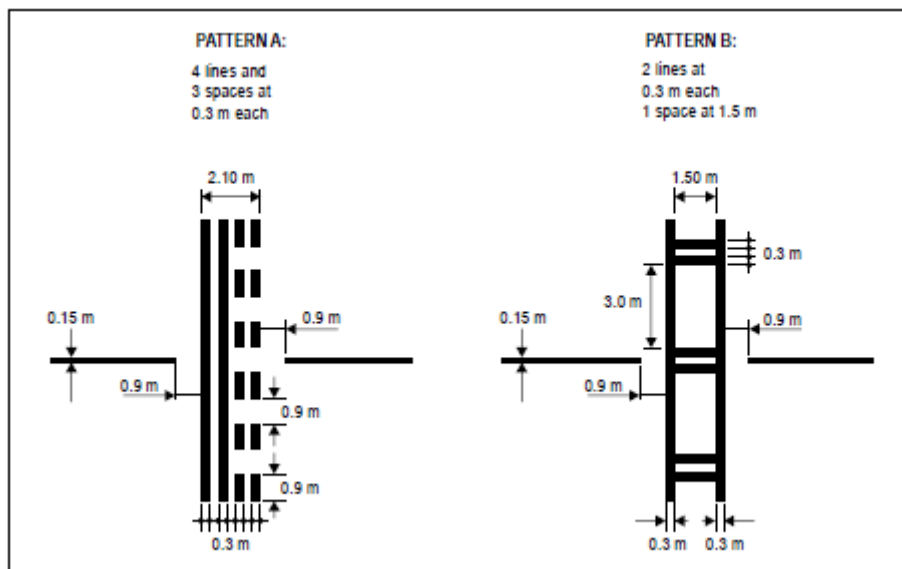

Figure 5-8. Runway-holding position markings

— **Taxiway designation marking**

Application

5.2.65 Taxiway designators should be provided on those taxiways or stubways, or both, where ATS includes the taxiway designators in instructions to taxiing aircraft.

Location

5.2.66 Taxiway designators should be located to the left of and adjacent to, the centre line as the taxiway or stubway, or both, is entered. The base of the letter or number should be level with the edge line of the runway or intersecting taxiway or stubway, or both, or as close to that position as the curvature of the centre line will allow.

Characteristics

5.2.67 Taxiway designators should be yellow letters or numbers to the same dimensions as provided for the aircraft stand identification numbers.

— **VOR aerodrome check-point marking**

The rule requirements for VOR aerodrome check point markings are contained in Part 139, Appendix E.2.12.

Application

5.2.68 When a VOR aerodrome check-point is established it must be indicated by a VOR check-point marking and sign.

See paragraph 5.4.66 for VOR aerodrome check-point sign.

Location

5.2.69 The VOR check-point marking should be centred on the spot at which the aircraft is to be parked to receive the correct VOR signal.

Characteristics

5.2.70 The VOR check point marking should consist of a white circle 6 m in diameter with a line width of 150 mm as shown in Figure 5-9.

5.2.71 When it is preferable for an aircraft to be aligned in a specific direction, a line should be provided that passes through the centre of the circle on the desired azimuth. The line should extend 6 m outside the circle in the desired direction of heading and terminate in an arrowhead. The width of line should be 150 mm (see Figure 5-9 (B)).

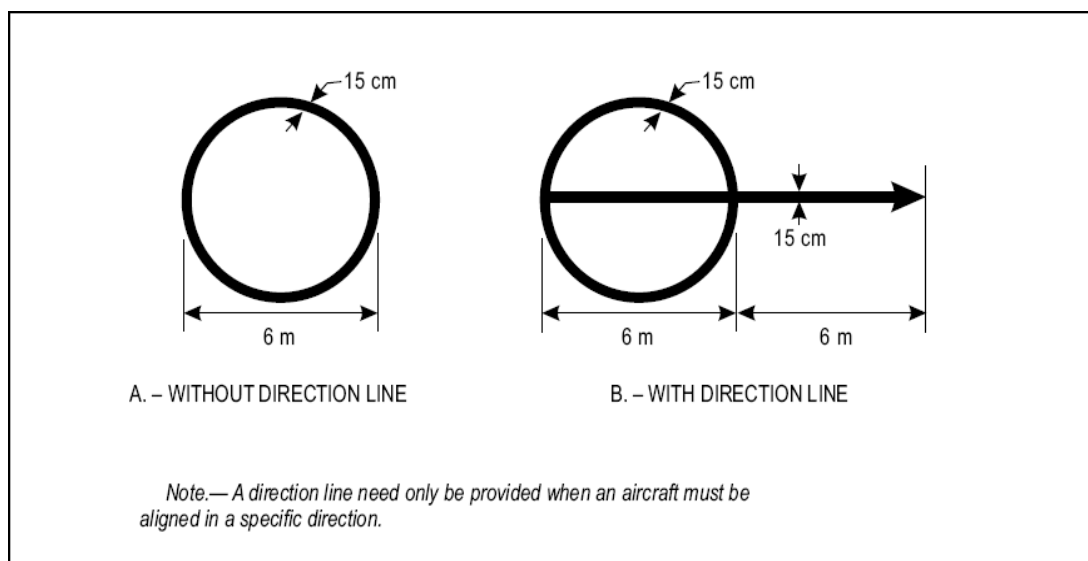

Figure 5-9. VOR aerodrome check point marking

— **Aircraft stand markings**

Application

5.2.72 Aircraft stand markings should be provided for designated parking positions on a paved apron.

Location

5.2.73 Aircraft stand markings should be located so as to provide the clearances specified in paragraph 3.12.6 when the nose wheel follows the stand marking.

Characteristics

5.2.74 Aircraft stand markings should include such elements as stand identification, lead-in line, turn bar, turning line, alignment bar, stop line and lead-out line, as are required by the parking configuration and to complement other parking aids.

— **Lead in lead out lines**

5.2.75 Lead-in, turning and lead-out lines should normally be continuous in length and have a width of not less than 150 mm. Where one or more sets of stand markings are superimposed on a stand marking, the lines should be continuous for the most demanding aircraft and broken for the other aircraft.

5.2.76 The curved portions of lead-in, turning and lead-out lines should have radii appropriate to the most demanding aircraft type for which the markings are intended.

5.2.77 Where it is intended that an aircraft proceed in one direction only, arrows pointing in the direction to be followed should be added as part of the lead-in and lead-out lines.

— **Aircraft stand identification**

5.2.78 An aircraft stand identification (letter or number, or both) should be adjacent to the lead-in line a short distance after the beginning of the lead-in line.

5.2.79 The number of the stand should be marked at the beginning of the nose wheel guideline to the particular stand in such a position to be easily identifiable to the pilot using the apron taxiway system.

5.2.80 The dimension of the yellow identification marking is shown in Figure 5-10. The dimensions may be scaled in proportion to use a minimum 4 m height numerals for stands used by aircraft of Code D and may be 2 m in height where the stand is only used for Code C or smaller aircraft

For aircraft stand identification sign, see paragraph 5.4.75.

5.2.81 Where two sets of aircraft stand markings are superimposed on each other in order to permit more flexible use of the apron and it is difficult to identify which stand markings should be followed, or safety would be impaired if the wrong marking was followed, then the identification of the aircraft for which the set of markings is intended should be added to the stand identification, for example 2A-B737, 2B-HS748.

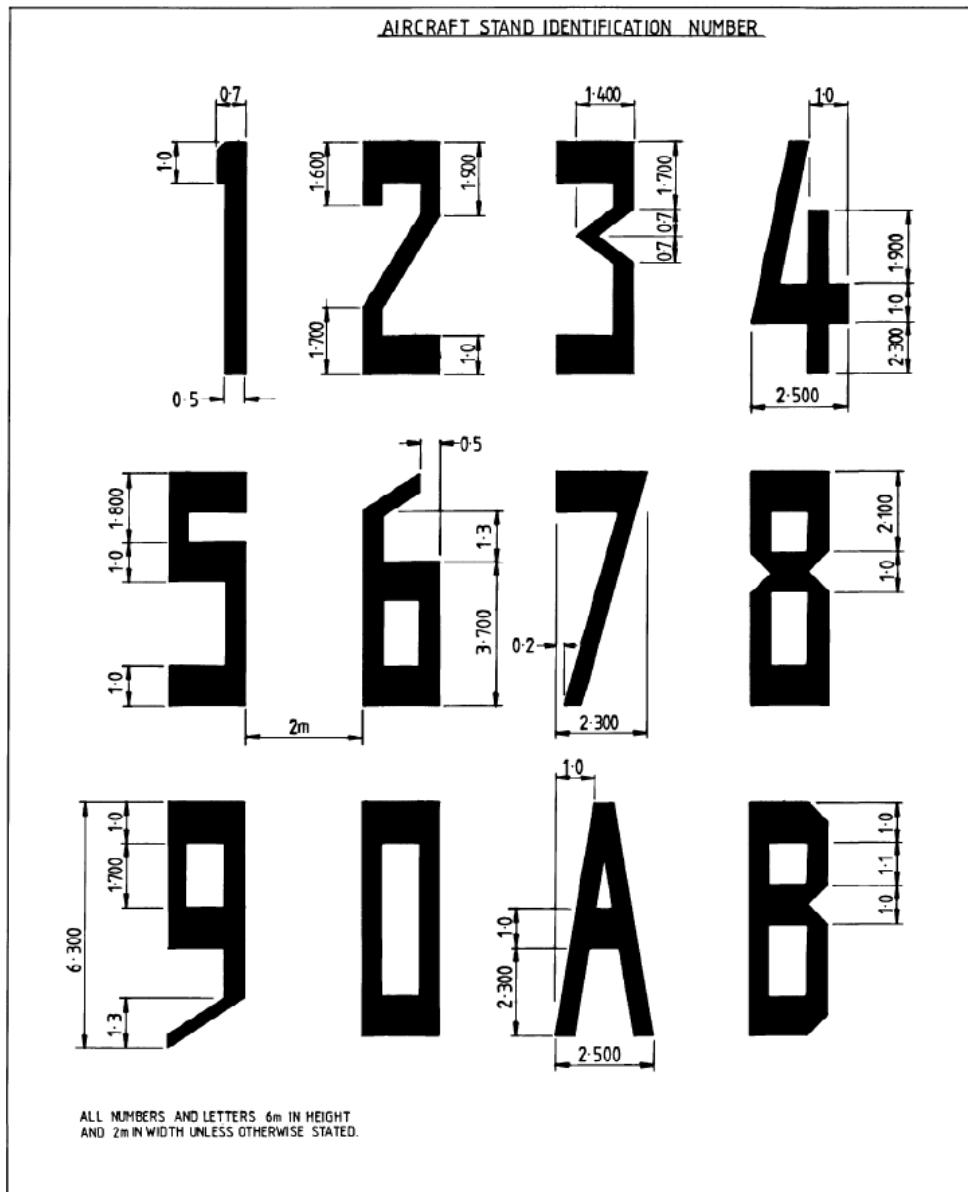

Figure 5-10. Aircraft stand identification markings

— **Turn bar**

5.2.82 A turn bar should be located on the left hand side and at right angles to the lead-in line, abeam the nose wheel position at the point of initiation of any intended turn. It should have a length and width of not less 6 m and 150 mm respectively, and include an arrowhead to indicate the direction of turn.

If placing the turn bar on the left hand side will cause confusion with other markings it may be located on the right hand side.

5.2.83 Where the stand is designed to accommodate more than one aircraft type the turn bar should signify which aircraft it applies to, by being either continuous or broken to match the continuous or broken taxi line for the differing aircraft types.

5.2.84 The word TURN should be written above this line together with the aircraft type if appropriate, for example TURN B737.

The distances to be maintained between the turn bar and the lead-in line may vary according to different aircraft types, taking into account the pilots field of view.

5.2.85 If more than one turn bar, or stop line, or both is required, they should be coded.

— **Alignment bar**

5.2.86 An alignment bar should be placed so as to be coincident with the extended centre line of the aircraft in the specified parking position and visible to the pilot during the final part of the parking manoeuvre. It should have a width of not less than 150 mm.

— **Stop line**

5.2.87 A stop line should be located on the left hand side and at right angles to the alignment bar, abeam the nose wheel stop block position at the intended point of stop. It should have a length and width of not less than 6 m and 150 mm, respectively.

5.2.88 The stop line should be marked with the type of aircraft intended to use the stop line if appropriate.

5.2.89 The distance between the end of the stop line and the lead-in line will vary according to different aircraft types, taking into account the pilot's field of view. For common aircraft types the distances are as follows—

Aircraft Type	Distance from nose wheel guideline to arrow
B747	13 m
B767	10 m
B737 & below	6 m

Nose wheel stop block

5.2.90 A nose wheel stop block is provided for use by the marshalls for each aircraft type normally using the parking position. The nose wheel stop block is also the reference point of the stand for the INS coordinates. It should be marked on all stands regardless of use by marshalls.

5.2.91 The nose wheel stop block should be located such that with the nose wheel on the stop block the ground refuelling points are accessible and all clearances from other aircraft, ground equipment and buildings are maintained.

5.2.92 The nose wheel stop block should be 0.5 m wide and 1 m long located centrally across the nose wheel guideline. If the gate is designed for use by more than one aircraft type then the aircraft type should be painted next to the particular stop block in letters no higher than 0.5 m facing the direction of the marshaller.

If the stop block is to be used by larger aircraft that when parked on the stop block would obscure the marking then the block should be scaled proportionally bigger so that it is still visible when those aircraft park on it, or alternatively the nose wheel stop block consist of 3m long lines 200mm wide located both sides of nose wheel positions

— **Equipment clearance lines**

Application

5.2.93 Equipment clearance lines should be provided to keep equipment clear of aircraft.

Location

5.2.94 The line should be located at the appropriate wingtip clearance, as defined in paragraph 3.13.6, outside the path of the critical aircraft.

Characteristics

5.2.95 The line should be a solid red line 100 mm wide. Where greater conspicuity is required the marking may be bordered with a thin white line. Where greater conspicuity is required the marking should be increased to 150 mm width and, if contrast is needed, may be bordered with a 150 mm white or black line on each side depending on the pavement surface colour.

— Equipment parking areas**Application**

5.2.96 These areas, if defined, are intended specifically for the parking of vehicles and aircraft servicing equipment.

Characteristics

5.2.97 The area should be enclosed by a solid white line 100 mm wide. The words **Equipment Limit** should be painted in letters no less than 300 mm high on the side of the line used by the ground equipment or vehicles and readable from that side.

Location

5.2.98 An equipment area should be located where it will not cause an obstruction to aircraft, vehicle movement or passenger movement.

Consideration should also be given to the jet blast from aircraft manoeuvring on the apron.

— Jet Wash and Propeller Wash**Application**

5.2.99 The aerodrome operator must protect people and property from the dangerous effects of jet blast.

Characteristics

5.2.100 The recommended maximum wind velocities which people, objects and buildings in the vicinity of an aeroplane may be subjected to should not be more than:

- (a) passengers and main public areas, where passengers have to walk and people are expected to congregate — 60 km/h
- (b) minor public areas, where people are not expected to congregate — 80 km/hr
- (c) public roads — 50 km/h where the vehicular speed may be 80 km/h or more, and — 60 km/h where the vehicular speed is expected to be below 80 km/h
- (d) personnel working near an aeroplane — 80 km/h
- (e) apron equipment — generally not in excess of 80 km/h
- (f) light aeroplane parking areas — desirably 60 km/h and not greater than 80 km/h
- (g) buildings and other structures — not exceeding 100 km/h.

Note: To offer protection from jet blast velocities the aerodrome operator may consider the provision of jet blast fences or the use of appropriate material.

— **No parking areas**

Application

5.2.101 Areas which should remain cleared of equipment and vehicles at all times.

Location

5.2.102 No parking areas should be located, for example, beneath the area of movement of an apron drive airbridge or areas of high jetblast.

Characteristics

5.2.103 The area required should be outlined by a red solid line 100 mm and 150 mm width. A form of cross hatching should be used to highlight the area, preferably with lines of 100 mm to 150 mm width, and spacing of 0.5 m to 1.0 m, proportioned to suit the size and shape of the area concerned.

— **Passenger walkway lines**

Application

5.2.104 Passenger walkway lines should be provided on an apron:

- (a) when passengers walk on the apron between a terminal building and the aircraft; or
- (b) when cargo loading and suchlike, guidance for safety is needed to avoid equipment, other aircraft, servicing activities, propellers; or
- (c) when security reasons require them.

5.2.105 It is desirable that passenger walkway lines be provided on a nationally consistent basis from the entrance/exit of the secured 'land-side' area of the terminal building to the aircraft stand, and particularly for all passenger movements across aprons, even if falling outside the above criteria

Location

5.2.106 Passenger walkway lines should be so located as to provide the quickest route to the aircraft. Care should be taken however to keep the route clear of aircraft, equipment parking areas and vehicle movement areas. The length of the lines crossing the manoeuvring area should be kept as short as possible.

5.2.107 Where appropriate, passenger walkway lines should be provided to give continuous guidance for passengers to/from the point at which passengers exit/arrive at the 'land-side' area of the terminal building.

Characteristics

5.2.108 Passenger walkway lines should consist of either (or a combination of)—

- (a) a pair of solid blue lines, 100 mm wide and 1 m apart. The lines should be joined by cross bars spaced between 3 m to 5 m apart. Instead of crossbars, footprints may be used, particularly towards the ends of walkways, to indicate their purpose to passengers. Where the walkway lines cross a vehicle movement lane, a form of white zebra crossing may be used; or

- (b) a solid light blue line 900mm wide bounded with a white line 100mm wide on each side may be used particularly where there is a significant distance from the terminal building exit/entrance to a point on the apron not further than the point at which any equipment clearance line is marked, or beyond which the marking could cause unhelpful clutter on the apron. Where the passenger walkway crosses a vehicle movement lane, a form of white zebra crossing may be used.

5.2.109 All paint marking should be non-slip and visible in all expected lighting and weather conditions. It should have good adhesion characteristics (to avoid FOD hazard) and be capable of withstanding high traffic loads.

— **Road-holding position marking**

The rule requirements for road-holding position markings are contained in Part 139, Appendix E.2.13.

Application

5.2.110 A road-holding position marking must be provided at all road entrances to a runway.

Location

5.2.111 The road-holding position marking should be located across the road at the holding position.

Characteristics

5.2.112 The road-holding position marking should be in accordance with the local road traffic regulations.

— **Mandatory instruction marking**

The rule requirements for mandatory instruction markings are contained in Part 139, Appendix E.2.14.

Application

109 5.2.113 Where it is impracticable to install a mandatory instruction sign in accordance with paragraph 5.4.12 a mandatory instruction marking must be provided on the surface of the pavement.

5.2.114 Where operationally required, such as on taxiways exceeding 60 m in width, a mandatory instruction sign should be supplemented by a mandatory instruction marking.

Location

5.2.115 The mandatory instruction marking on taxiways where the code letter is A, B, C or D must be located across the taxiway equally placed about the taxiway centre line and on the holding side of the runway-holding position marking as shown in Figure 5-11 (A). The distance between the nearest edge of the marking and the runway-holding position marking or the taxiway centre line marking must be not less than 1 m.

5.2.116 The mandatory instruction marking on taxiways where the code letter is E or F must be located on both sides of the taxiway centre line marking and on the holding side of the runway-holding position marking as shown in Figure 5-11 (B). The distance between the nearest edge of the marking and the runway-holding position marking or the taxiway centre line marking must be not less than 1 m.

Note: Except where operationally required, a mandatory instruction marking should not be located on a runway.

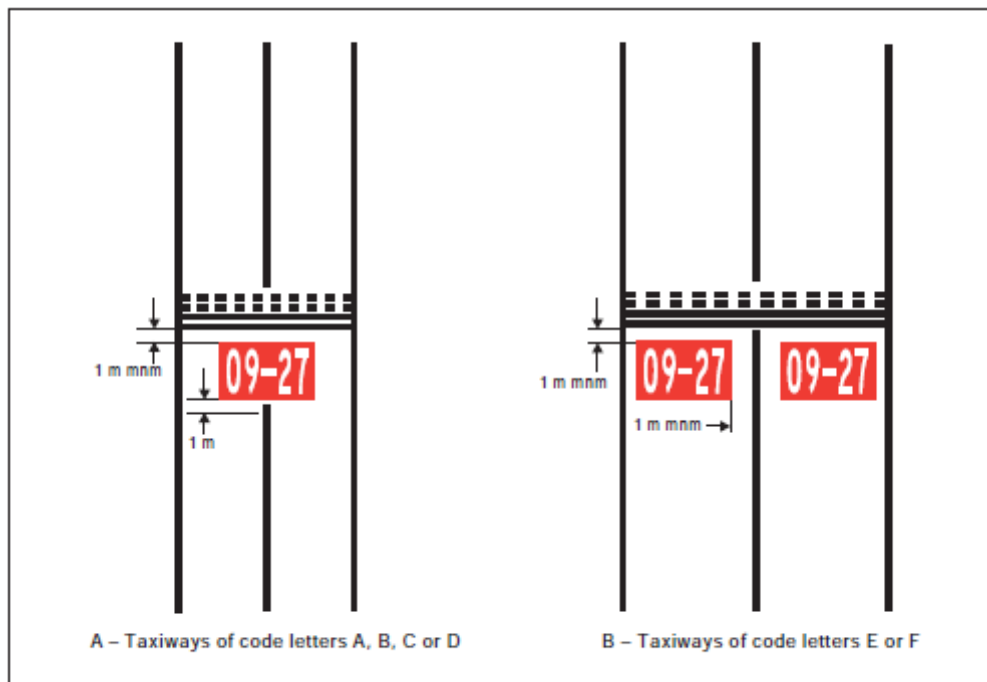

Figure 5-11. Mandatory instruction marking

Characteristics

5.2.117 A mandatory instruction marking should consist of an inscription in white on a red background. Except for a NO ENTRY marking, the inscription should provide information identical to that of the associated mandatory instruction sign.

5.2.118 A NO ENTRY marking should consist of an inscription in white reading NO ENTRY on a red background.

5.2.119 Where there is insufficient contrast between the marking and the pavement surface, the mandatory instruction marking should include an appropriate border, preferably white or black.

5.2.120 The character height should be 4 m. The inscriptions should be in the form and proportions shown in Appendix 3 of this AC.

5.2.121 The background should be rectangular and extend a minimum of 0.5 m laterally and vertically beyond the extremities of the inscription.

— Information marking

The rule requirements for information markings are contained in Part 139, Appendix E.2.15.

Application

5.2.122 Where an information sign would normally be installed and it is physically impossible to install a sign, an information marking must be displayed on the surface of the pavement.

5.2.123 Where operationally required an information sign should be supplemented by an information marking.

Location

5.2.124 The information marking should be displayed across the surface of the taxiway or apron where necessary and positioned so as to be legible from the cockpit of an approaching aircraft.

Characteristics

5.2.125 An information marking should consist of:

- (a) an inscription in yellow, when it replaces or supplements a location sign
- (b) an inscription in black, when it replaces or supplements a direction or destination sign.

5.2.126 Where there is insufficient contrast between the marking and the pavement surface, the marking should include:

- (a) a black background where the inscriptions are in yellow
- (b) a yellow background where the inscriptions are in black.

5.2.127 The character height should be 4 m. The inscriptions should be in the form and proportions shown in Appendix 3 of this AC.

— Runway ahead**Application**

5.2.128 A RUNWAY AHEAD paint marking should be considered to supplement the mandatory hold signage. When used the RUNWAY AHEAD paint marking should be unabbreviated.

Location

5.2.129 The RUNWAY AHEAD marking should be displayed across the surface of the taxiway or apron where necessary and positioned so as to be legible from the cockpit of an approaching aircraft.

Characteristics

5.2.130 A RUNWAY AHEAD marking should consist of white letters on a red background, as below:

**— Demarcation line separating manoeuvring area and apron****Application**

5.2.131 To display a boundary of responsibility (e.g. Airport – ATC)

Location

5.2.132 The demarcation line should be marked to show separation of manoeuvring area from apron.

Characteristics

5.2.133 It should be a solid red line. When there is insufficient contrast between the marking and the pavement surface, it should be surrounded by a white borderline, or it can two lines side by side of alternating red and white colour (checked). The width of each line marking used should be not less than 30cm.

— **Painting specification**

Runway & taxiway

5.2.134 The minimum standard of paint to be used for runway and taxiway markings should comply with the Transit New Zealand M07 specification and be a brand and type currently on the Transit New Zealand list of paints approved for use on state highways.

Information available at <http://www.nzta.govt.nz/resources/roadmarking-paints/>

5.2.135 The maximum permitted dimensional tolerances of markings should be:

- (a) gap length between segments \pm 300 mm
- (b) length of segments \pm 150 mm
- (c) for width of lines where the width:
 - (i) is up to 150 mm wide, +10 mm - 5 mm:
 - (ii) is over 150 mm wide , +15 mm - 10 mm
- (d) where flush lights or reflectors are placed on the paint lines the paint may be omitted for a length of 150 mm before and after the light fitting or reflector.

Aprons

5.2.136 The following standard colours from NZS 7702 should be used on aprons where required:

Yellow	Colour 356 Golden Yellow
Red	Colour 537 Signal Red
Blue	Colour 112 Arctic Blue

5.2.137 Any paint spray drift or splatter should be cleaned off all light fittings.

5.3 Lights

The rule requirements for lights are contained in Part 139, Appendix E.3.

— Lights which may endanger the safety of aircraft

5.3.1 A non-aeronautical ground light near an aerodrome which may endanger the safety of aircraft should be extinguished, screened or otherwise modified so as to eliminate the source of danger.

— Lights which may cause confusion

5.3.2 A non-aeronautical ground light which, by reason of its intensity, configuration or colour, might cause confusion or prevent the clear interpretation of aeronautical ground lights should be extinguished, screened or otherwise modified so as to eliminate such a possibility. In particular, attention should be directed to a non-aeronautical ground light visible from the air within the areas described hereunder.

(a) Instrument runway - code number 4:

within the areas before the threshold and beyond the end of the runway extending at least 4500 m in length from the threshold and runway end and 750 m either side of the extended centre line in width.

(b) Instrument runway - code number 2 or 3:

as in (a) except that the length should be 3000 m.

(c) Instrument runway - code number 1 and non-instrument runways:

within the approach area.

— Elevated approach lights

The rule requirements for elevated approach lights are contained in Part 139, Appendix E.3.1.

5.3.3 Elevated approach lights and their supporting structures up to 300 m from the threshold must be light weight and frangible. Beyond 300 m and the supporting structure is:

(a) higher than 12 m, only the top 12 m must be frangible

(b) surrounded by non-frangible objects, only that part of the structure that extends above the surrounding objects must be frangible

Any approach light fixture or supporting structure that is not, in itself, sufficiently conspicuous, must be suitably marked.

— Elevated lights

The rule requirements for elevated lights are contained in Part 139, Appendix E.3.2.

5.3.4 Elevated runway, stopway and taxiway lights must be light-weight and frangible mounted. Their height must be sufficiently low to preserve clearance for propellers and for the engine pods of jet aircraft.

— Surface lights

The rule requirements for surface lights are contained in Part 139, Appendix E.3.3.

5.3.5 Light fixtures inset in the surface of runways, stopways, taxiways and aprons must be designed and fitted to withstand being run over by the wheels of an aircraft without damage either to the aircraft or the lights themselves.

— **Light intensity and control**

The rule requirements for light intensity and control are contained in Part 139, Appendix E.3.4.

5.3.6 The intensity of runway lighting must be adequate for the minimum conditions of visibility and ambient light in which use of the runway is intended, and compatible with that of the nearest section of the approach lighting system when provided.

While the lights of an approach lighting system may be of higher intensity than the runway lighting, it is good practice to avoid abrupt changes in intensity as these could give a pilot a false impression that the visibility is changing during the approach.

5.3.7 A suitable intensity control must be incorporated to allow for adjustment of the light intensity to meet the prevailing conditions. Separate intensity controls or other suitable methods should be provided to ensure that the following systems, when installed, can be operated at compatible intensities:

- (a) approach lighting system
- (b) runway edge lights
- (c) runway threshold lights
- (d) runway end lights
- (e) runway centre line lights
- (f) runway touchdown zone lights
- (g) taxiway centre line or edge lights
- (h) visual approach guidance systems.

— **Aerodrome beacon**

The rule requirements for aerodrome beacons are contained in Part 139, Appendix E.3.5.

Application

5.3.8 An aerodrome beacon must be provided at an aerodrome intended for use at night when aircraft navigate predominantly by visual means, reduced visibilities are frequent, or it is difficult to locate the aerodrome from the air due to surrounding lights or terrain.

Location

5.3.9 The aerodrome beacon should be on or adjacent to the aerodrome, located to ensure that it is not shielded by objects in significant directions, and does not dazzle a pilot approaching to land.

Characteristics

5.3.10 The aerodrome beacon should show white flashes only. The frequency of the flashes should be from 12 to 30 per minute. The light from the beacon should show at all angles of

azimuth. The vertical light distribution should extend upwards from an elevation of not more than 1° to an elevation sufficient to provide guidance at the maximum elevation at which the beacon is intended to be used.

— **Identification beacon**

Application

5.3.11 An identification beacon should be provided at an aerodrome which is intended for use at night and cannot be easily identified from the air by other visual means.

Location

5.3.12 The identification beacon should be located on the aerodrome in an area of low ambient background lighting, and where the beacon is not shielded by objects in significant directions and does not dazzle a pilot approaching to land.

Characteristics

5.3.13 An identification beacon should show green with a peak intensity of not less than 2000 cd. The light should be emitted at all angles of azimuth and up to at least 45° above the horizontal. The identification characters should be transmitted in the International Morse Code.

— **Approach lighting systems**

The rule requirements for approach lighting systems are contained in Part 139, Appendix E.3.6.

Application

5.3.14 An approach lighting system should comprise one or more of the following facilities—

- (a) low intensity approach lighting system (1 red bar)
- (b) low intensity approach lighting system (2 red bar)
- (c) high intensity approach lighting system (precision approach category I)
- (d) high intensity approach lighting system (precision approach category II or III).

5.3.15 In addition an approach lighting system may be augmented by one or more of the following facilities—

- (a) runway lead-in lights (RLLS)
- (b) circling guidance lights (CGL)
- (c) runway end identifier lights (REIL).

5.3.16 All lights of a runway approach lighting system should be designed and installed in such a manner that they will not dazzle or confuse a pilot when approaching to land, taking off or taxiing.

— **Low intensity approach lighting system 1 red bar**

Application

5.3.17 Where physically practicable, a low intensity approach lighting system 1 red bar (LIL ALS - 1 Bar) is the minimum standard that should be provided for all instrument runways or for a secondary runway at an international aerodrome which is not an instrument runway. Where

physically practicable, the system, or other visual aids should be provided for non-instrument runways used at night where additional visual guidance is required.

Location

5.3.18 The system should consist of a single row of lights on the extended centre line of the runway extending 420 m from the threshold, with a row of lights forming a crossbar positioned at a distance of 300 m from the threshold. (See Figure 5-12A).

5.3.19 The lights forming the centre line should be placed at longitudinal intervals of 60 m, except that, when it is desired to improve the guidance, an interval of 30 m may be used. The innermost light should be located either 60 m or 30 m from the threshold, depending on the longitudinal interval selected for the centre line lights.

5.3.20 The lights forming the crossbar should be nearly as practicable in a horizontal straight line at right angles to, and bisected by, the line of the centre line lights. The crossbar should be 30 m in length and consist of 5 lights on each side of the centre line. The lights of the crossbar should be spaced so as to produce a linear effect, except that a gap not exceeding 6 m may be left between the centre line and the first light on each side of the centre line.

5.3.21 The system should lie as nearly as practicable in the horizontal plane passing through the threshold (see Figure 5-13), provided that:

- (a) No lights should be screened from an approaching aircraft.
- (b) As far as possible, no object should protrude through the plane of the approach lights within a distance of 60 m from the centre line of the system. Where this is unavoidable, as in the case of a single isolated object protruding through the plane of the lights, for example an ILS installation, the object should be treated as an obstacle and marked and lit accordingly.

Characteristics

5.3.22 The lights may be fixed or variable intensity and the colour (usually red) such as to ensure that the system is readily distinguishable from other aeronautical ground lights, and from extraneous lighting, if present.

5.3.23 The lights should show at all angles of the azimuth necessary to a pilot on base leg and final approach. The intensity of the lights should be adequate for all conditions of visibility and ambient light for which the system has been provided.

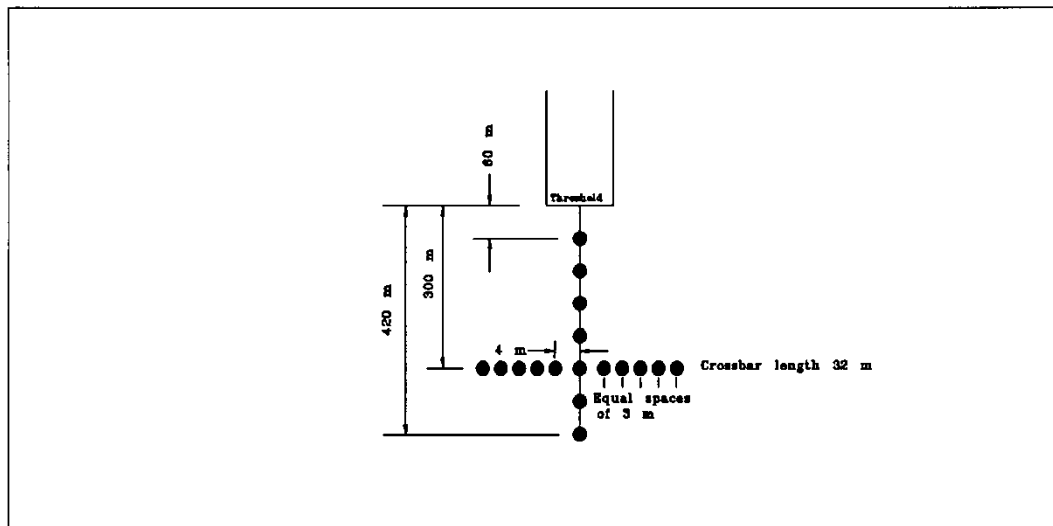

Figure 5-12A. Low intensity approach lighting system 1 Bar

— **Low intensity approach lighting system 2 red bar**

Application

5.3.24 A low intensity approach lighting system 2 red bar (LIL ALS - 2 Bar) should be provided for any precision approach domestic runway intended to be operated to precision approach category I minima.

Location

5.3.25 A low intensity approach lighting system (2 bar) should consist of a single row of lights on the extended centre line of the runway extending, whenever possible, 900 m from the threshold with two rows of lights forming crossbars positioned at a distance of 300 m and 600 m from the threshold. (See Figure 5-12B).

5.3.26 The lights forming the centre line should be placed at longitudinal intervals of 60 m, except that, when it is desired to improve the guidance, an interval of 30 m may be used. The innermost light should be located either 60 m or 30 m from the threshold, depending on the longitudinal interval selected for the centre line lights.

5.3.27 The lights forming the crossbars should be nearly as practicable in a horizontal straight line at right angles to, and bisected by, the line of the centre line lights. The crossbar at 300 m from the threshold should consist of 5 lights on each side of the centre line. The two lights closest to the centre line should be approximately 4 m from the centre line and the remaining lights approximately 3 m apart. The crossbar at 600 m from the threshold should consist of 7 lights either side of the centre line with the spacing as for the first crossbar.

5.3.28 The system should lie as nearly as practicable in the horizontal plane passing through the threshold (see Figure 5-13), provided that:

- (a) No lights should be screened from an approaching aircraft.
- (b) As far as possible, no object should protrude through the plane of the approach lights within a distance of 60 m from the centre line of the system. Where this is unavoidable, as in the case of a single isolated object protruding through the plane of the lights, for example an ILS installation, the object should be treated as an obstacle and marked and lighted accordingly.

Characteristics

5.3.29 The red lights may be of fixed or variable intensity.

5.3.30 The lights should show at all angles of azimuth necessary to a pilot on base leg and final approach. The intensity of the lights should be adequate for all conditions of visibility and ambient light for which the system has been provided.

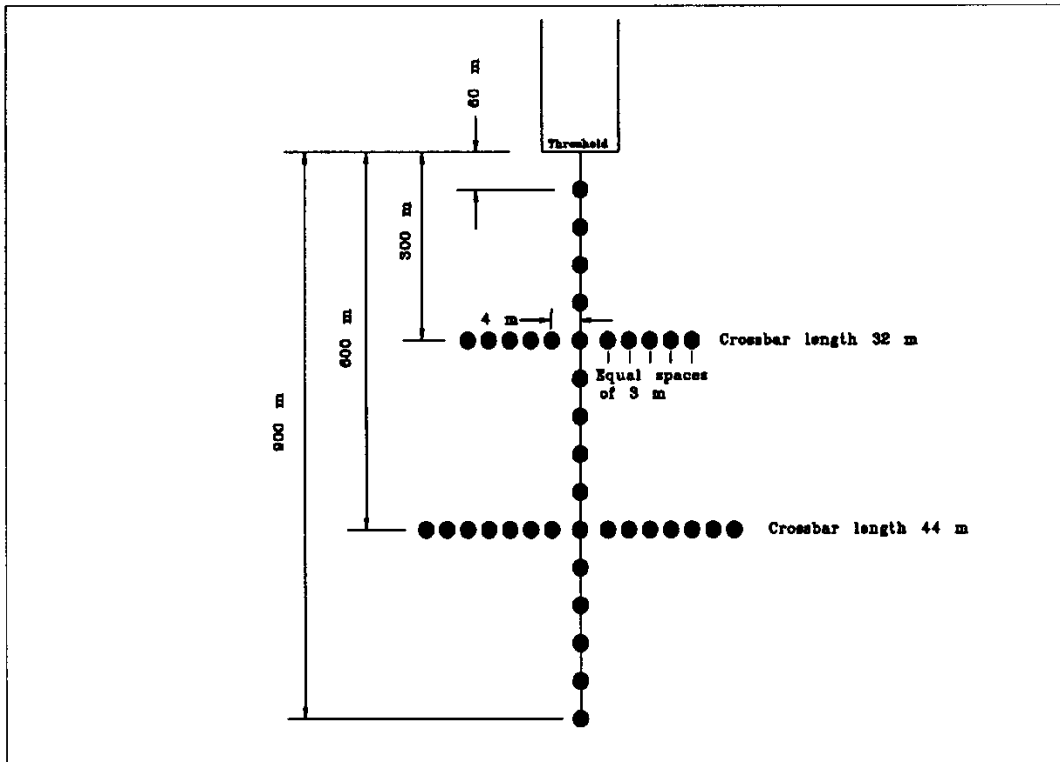

Figure 5-12B. Low intensity approach lighting system 2 Bar

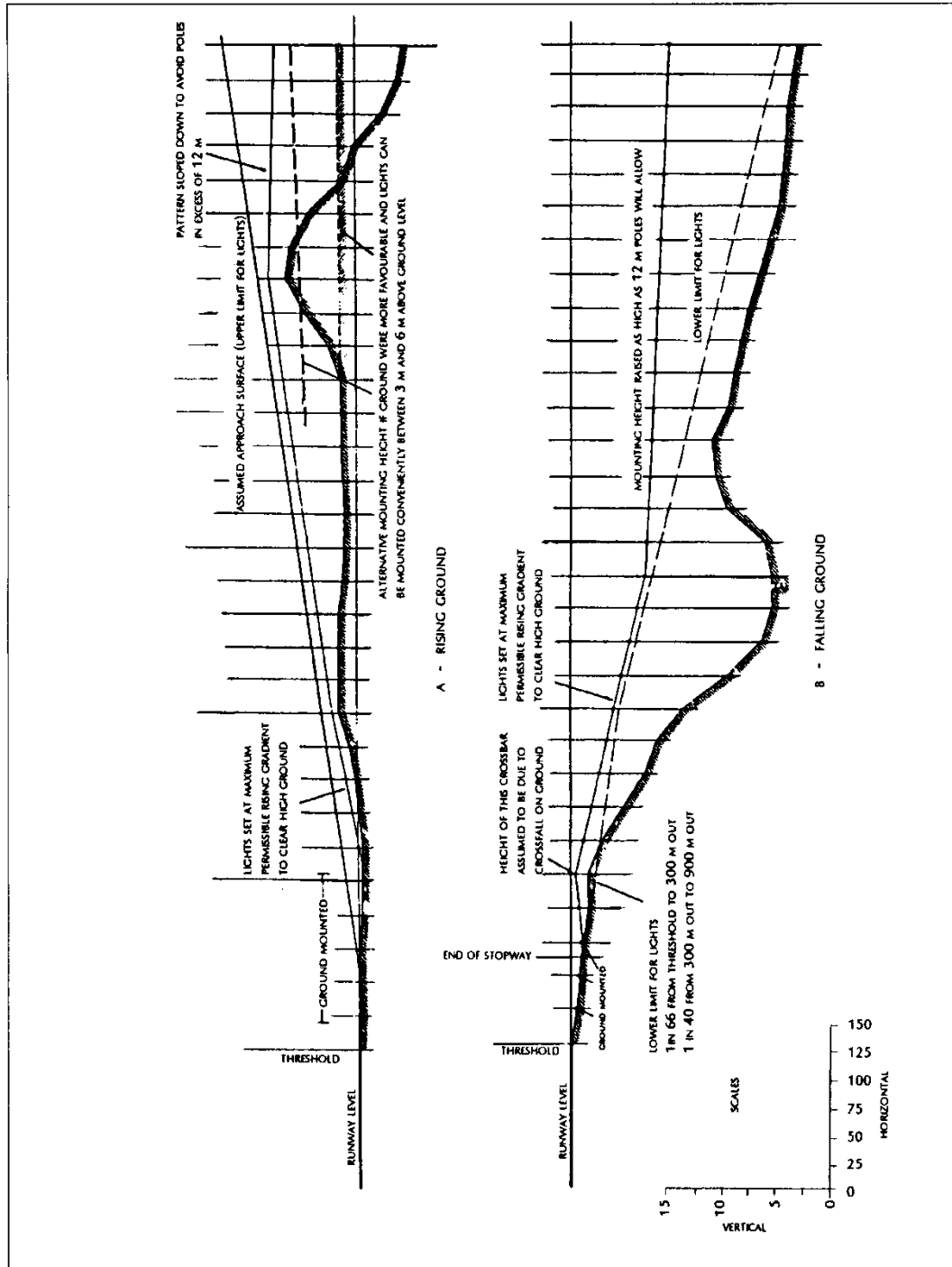

Figure 5-13. Vertical installation tolerances

— **High intensity approach lighting system (Cat I)**

Application

5.3.31 Where physically practicable, the following approach lighting system should be provided to serve a precision approach international or domestic runway intended to be operated to precision approach category I minima.

Location

5.3.32 The high intensity approach lighting system should consist of a coded pattern of white lights 900 m long on the extended runway centre line together with 5 rows of lights forming crossbars at 150 m intervals from the threshold. (See Figure 5-14).

5.3.33 For the first 300 m from the threshold the system should consist of one light spaced at intervals of 30 m with the first light spaced 30 m from the threshold.

5.3.34 For the next 300 m two white lights should be placed every 30 m on the extended centre line with one light to either side. The spacing between these lights should be approximately 0.75 m

5.3.35 For the last 300 m one white light should be placed on the extended centre line at intervals of 30 m. On either side of these lights a white light should be placed at a spacing of approximately 1.5 m.

5.3.36 The lights forming the crossbars should be as nearly as practicable in a horizontal straight line at right angles to, and bisected by, the line of the centre line lights. The crossbar located 300 m from the threshold should consist of 5 lights either side of the centre line. The outer light should be at a distance of approximately 15 m from the centre line with the other lights approximately 4 m apart. The outer ends of the crossbars should either:

- (a) lie on two straight lines that converge to meet the runway centre line 300 m in from the landing threshold:
- (b) lie on two straight lines that are parallel to the line of the centre line lights.

5.3.37 The system should lie as nearly as practicable in the horizontal plane passing through the threshold (see Figure 5-13), provided that:

- (a) No lights should be screened from an approaching aircraft.
- (b) As far as possible, no object should protrude through the plane of the approach lights within a distance of 60 m from the centre line of the system. Where this is unavoidable, as in the case of a single isolated object protruding through the plane of the lights, for example an ILS installation, the object should be treated as an obstacle and marked and lighted accordingly.

Characteristics

5.3.38 The lights of the approach system should consist of high intensity unidirectional white lights. The lights should show towards aircraft on approach to the runway. The intensity of the lighting system should be able to be varied.

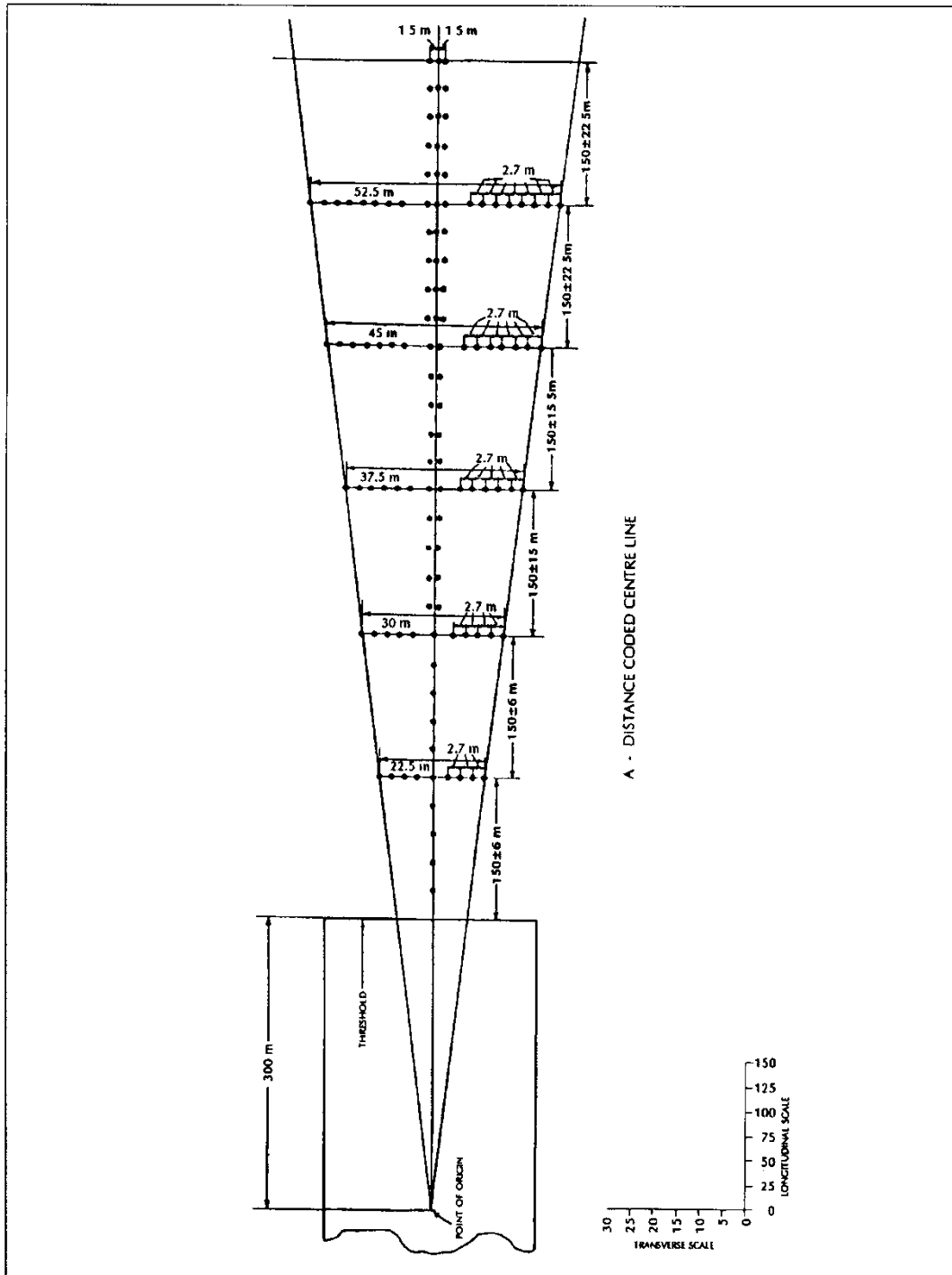

Figure 5-14. Precision approach category I lighting systems

- High intensity approach lighting system (category II or III)

Application

5.3.39 The following lighting system should be provided to serve a runway intended to be operated to ICAO precision approach runway category II or III minima.

Location

5.3.40 The approach lighting system should consist of a row of lights on the extended centre line of the runway, extending, wherever possible, over a distance of 900 m from the runway

threshold. In addition, the system should have two side rows of lights, extending 270 m from the threshold, and two crossbars, one at 150 m and one at 300 m from the threshold all as shown in Figure 5-15. The lights forming the centre line and side rows should be placed at longitudinal intervals of 30 m with the innermost lights located 30 m from the threshold.

5.3.41 The crossbar provided at 150 m from the threshold should fill in the gaps between the centre line and the side row lights. The crossbar provided at 300 m from the threshold should extend on both sides of the centre line lights to a distance of 15 m from the centre line.

5.3.42 If the centre line beyond a distance of 300 m from the threshold consists of lights rather than barrettes, additional crossbars should be provided at 450 m, 600 m and 750 m from the threshold. The outer ends of these crossbars should lie on two straight lines that either are parallel to the centre line or converge to meet the runway centre line 300 m from the threshold.

5.3.43 The system should lie as nearly as practicable in the horizontal plane passing through the threshold (see Figure 5-13), provided that:

- (a) No lights should be screened from an approaching aircraft.
- (b) As far as possible, no object should protrude through the plane of the approach lights within a distance of 60 m from the centre line of the system. Where this is unavoidable, as in the case of a single isolated object protruding through the plane of the lights, for example an ILS installation, the object should be treated as an obstacle and marked and lighted accordingly.

Characteristics

5.3.44 The centre line of the lighting system for the first 300 m from the threshold should consist of barrettes showing variable white, except that, where the threshold is displaced 300 m or more, the centre line may consist of single light sources showing variable white. The barrettes should be at least 4 m in length. When barrettes are composed of lights approximating to point sources, the lights should be uniformly spaced at intervals of not more than 1.5 m

5.3.45 Beyond 300 m from the threshold each centre line should consist of either:

- (a) a barrette as used on the inner 300 m:
- (b) two light sources in the central 300 m of the centre line and three light sources in the outer 300 m of the centre line:

all of which should show variable white.

5.3.46 If the centre line beyond 300 m from the threshold consists of barrettes as described above, each barrette beyond 300 m should be supplemented by a capacitor discharge light, except where such lighting is considered unnecessary taking into account the characteristics of the system and the nature of the meteorological conditions. Each capacitor discharge light should be flashed twice a second in sequence, beginning with the outermost light and progressing toward the threshold to the innermost light of the system. The design of the electrical circuit should be such that these lights can be operated independently of the other lights of the approach system.

5.3.47 The side row should consist of barrettes showing red. The length of a side row barrette and the spacing of its lights should be equal to those of the touchdown lights. The intensity of the red lights should be compatible with the intensity of the white lights.

5.3.48 The lights forming the crossbars should be fixed lights showing variable white. The lights should be uniformly spaced at intervals of not more than 2.7 m.

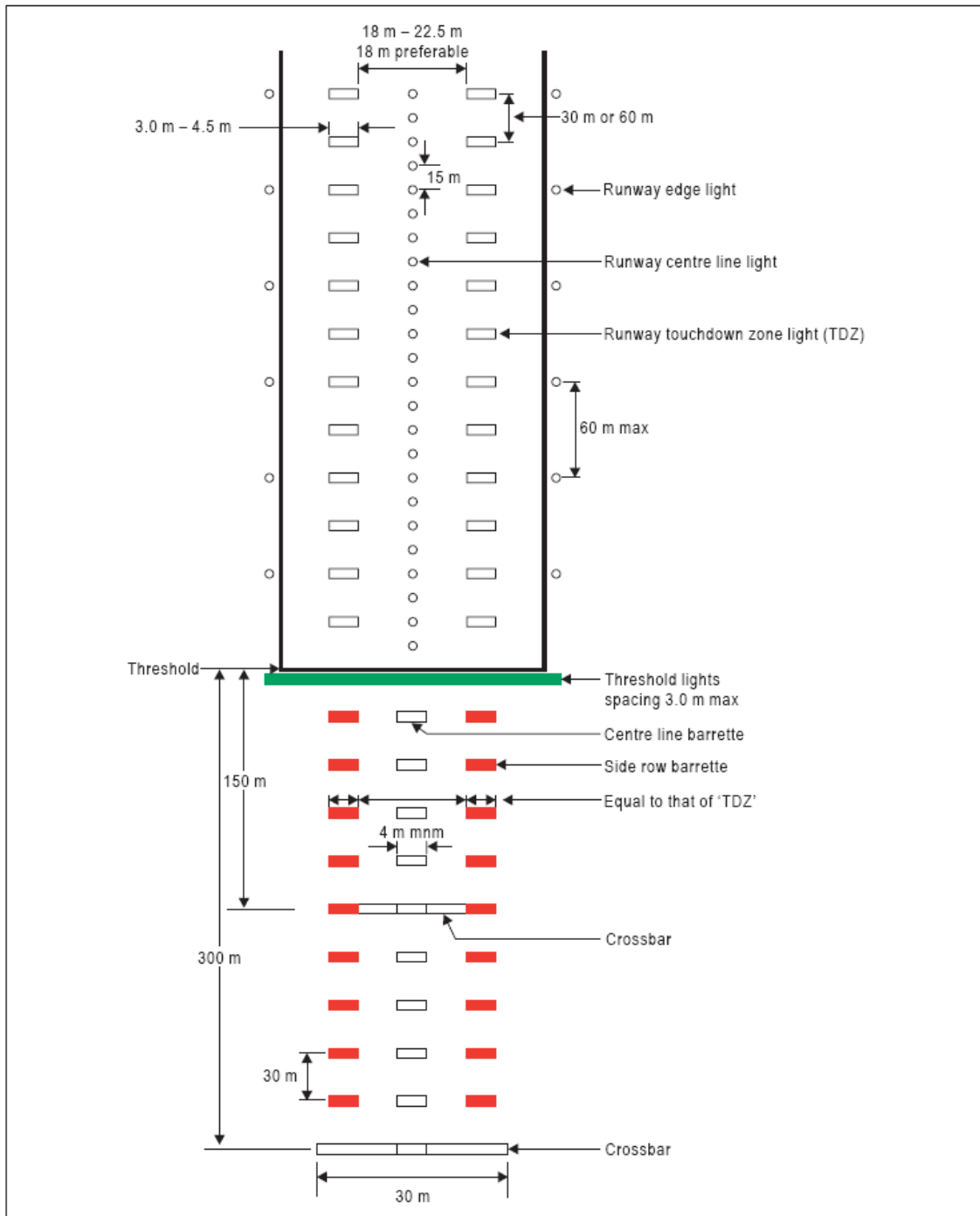

Figure 5-15. Inner 300 m approach and runway lighting for precision approach runways, categories II and III.

— **Visual approach slope indicator systems**

The rule requirements for visual approach slope indicator systems are contained in Part 139, Appendix E.3.7.

Application

5.3.49 A visual approach slope indicator system must be provided to serve the approach to a runway whether or not the runway is served by other visual approach aids or by non-visual aids, where one of the following conditions exist:

- (a) the runway is used by turbojet or other aeroplanes with similar approach guidance requirements:
- (b) the pilot of any type of aeroplane may have difficulty in judging the approach due to:
 - (i) inadequate visual guidance such as is experienced during an approach over water or featureless terrain by day or in the absence of sufficient extraneous lights in the approach area by night:
 - (ii) misleading information such as is produced by deceptive surrounding terrain or runway slopes:
- (c) the presence of objects in the approach area may involve serious hazard if an aeroplane descends below the normal approach path, particularly if there is no non-visual or other visual approach aids to give warning of such objects:
- (d) physical conditions at either end of the runway present a serious hazard in the event of an aeroplane undershooting or overrunning the runway:
- (e) terrain or prevalent meteorological conditions are such that the aeroplane may be subject to unusual turbulence during approach.

5.3.50 The standard visual approach slope indicator systems, as shown in Figure 5-16, should consist one of the following:

- (a) VASIS or AVASIS conforming to the specifications contained in paragraphs 5.3.53 to 5.3.68 inclusive:
- (b) T-VASIS or AT-VASIS conforming to the specifications contained in paragraphs 5.3.69 to 5.3.86 inclusive:
- (c) PAPI or APAPI systems conforming to the specifications contained in 5.3.87 to 5.3.104 inclusive.

The specifications for PAPI and APAPI have replaced those of VASIS and AVASIS, and that these latter two systems have ceased to be standard New Zealand visual approach slope indicator systems. The specifications for VASIS and AVASIS are included here for reference purposes for existing systems only.

5.3.51 PAPI, T-VASIS or AT-VASIS must be provided where the aerodrome reference code number is 3 or 4 and when one or more of the conditions specified in paragraphs 5.3.49 (a) to (e) exist.

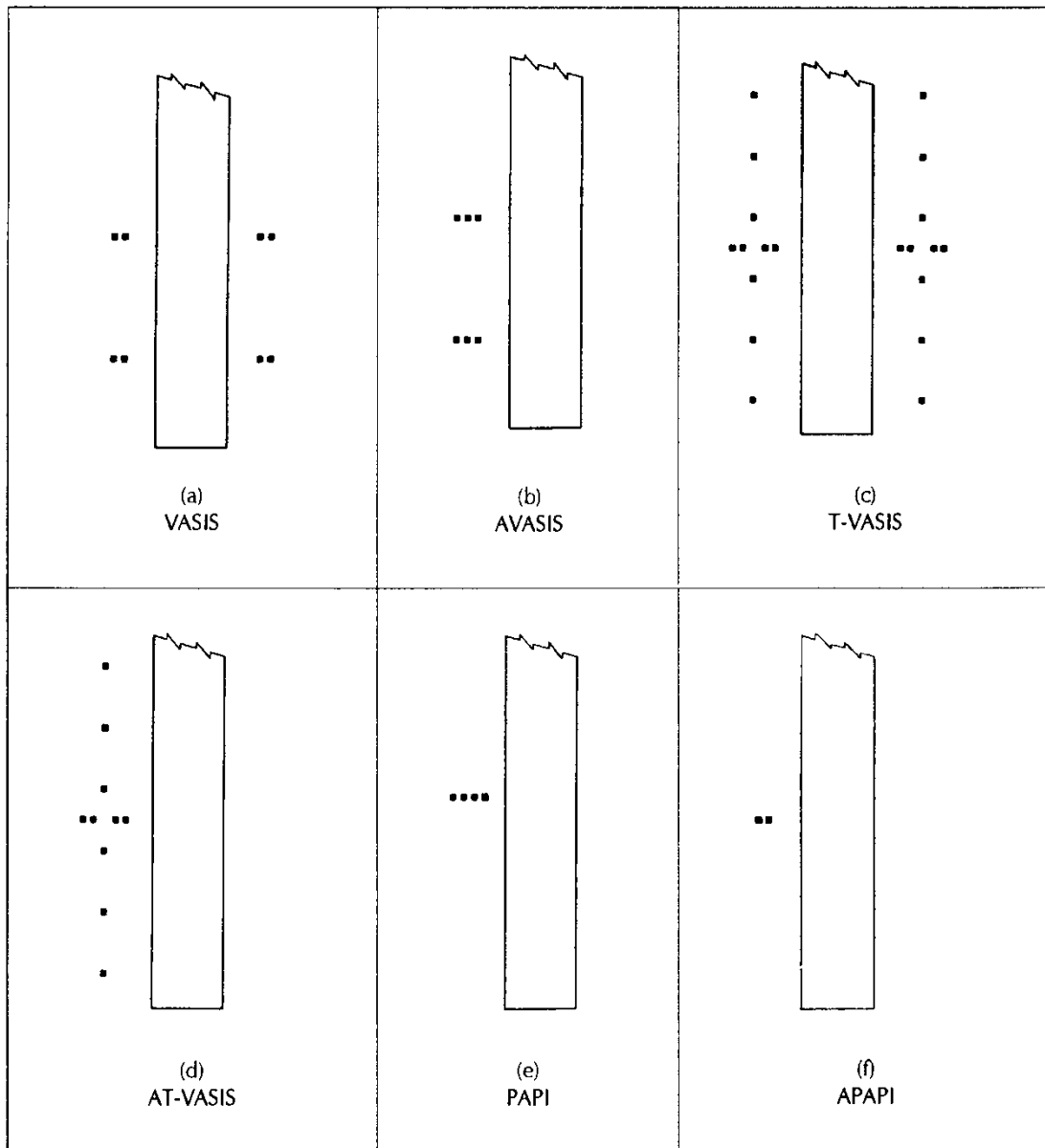

Figure 5-16. Visual approach slope indicator systems

5.3.52 PAPI or APAPI must be provided where the aerodrome reference code number is 1 or 2 and when one or more of the conditions specified in paragraphs 5.3.49 (a) to (e) exist.

With respect to AVASIS, the specified eye-to-wheel height is based on a system installed in accordance with the distance specified in Figure 5-17 (That is without application of tolerances) and the downwind light units of AVASIS set at 2° or the middle of the light units set at 2°30'. When a system is not installed in accordance with the specified location and elevation setting angles, there will be a pro rata change in the permissible eye-to-wheel height.

— VASIS and AVASIS

Description

5.3.53 The VASIS should consist of eight light units arranged in upwind and downwind positions and symmetrically disposed about the runway centre line in the form of two pairs of wings bars with two light units in each wing bar, as shown in Figure 5-16(a).

5.3.54 The AVASIS should consist of six light units as shown in Figure 5-16(b) and disposed on one side of the runway centre line with three light units in each wing bar.

Display

5.3.55 Each light unit should project a beam of light having a white colour in its upper part and a red colour in its lower part, as shown in Figure 5-17. The light units should be arranged in such a manner that the pilot during approach will:

- when above the approach slope, see all lights to be white in colour
- when on the approach slope, see the downwind lights white and the upwind lights red
- when below the approach slope, see all the lights to be red in colour.

When the pilot is well below the approach slope, the lights of the two wings located at the same side of a runway will merge into one red signal.

Location

5.3.56 The wing bars and light units should be located as shown in Figure 5-18 subject to the installation tolerances given therein. An installation should be so designed that the application of large tolerances is avoided wherever possible.

5.3.57 The lights forming the upwind and downwind wing bars should be mounted so as to appear to the pilot of an approaching aircraft to be substantially in a horizontal line. The light units should be sufficiently light and frangible not to constitute a hazard to aeroplanes.

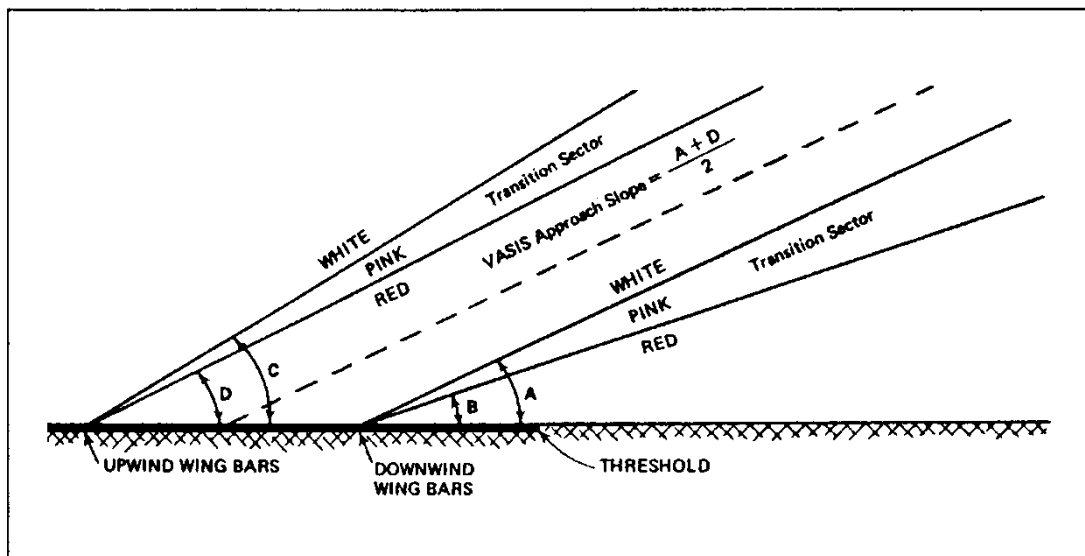

Figure 5-17. Light beam and angle of elevation setting of VASIS and AVASIS

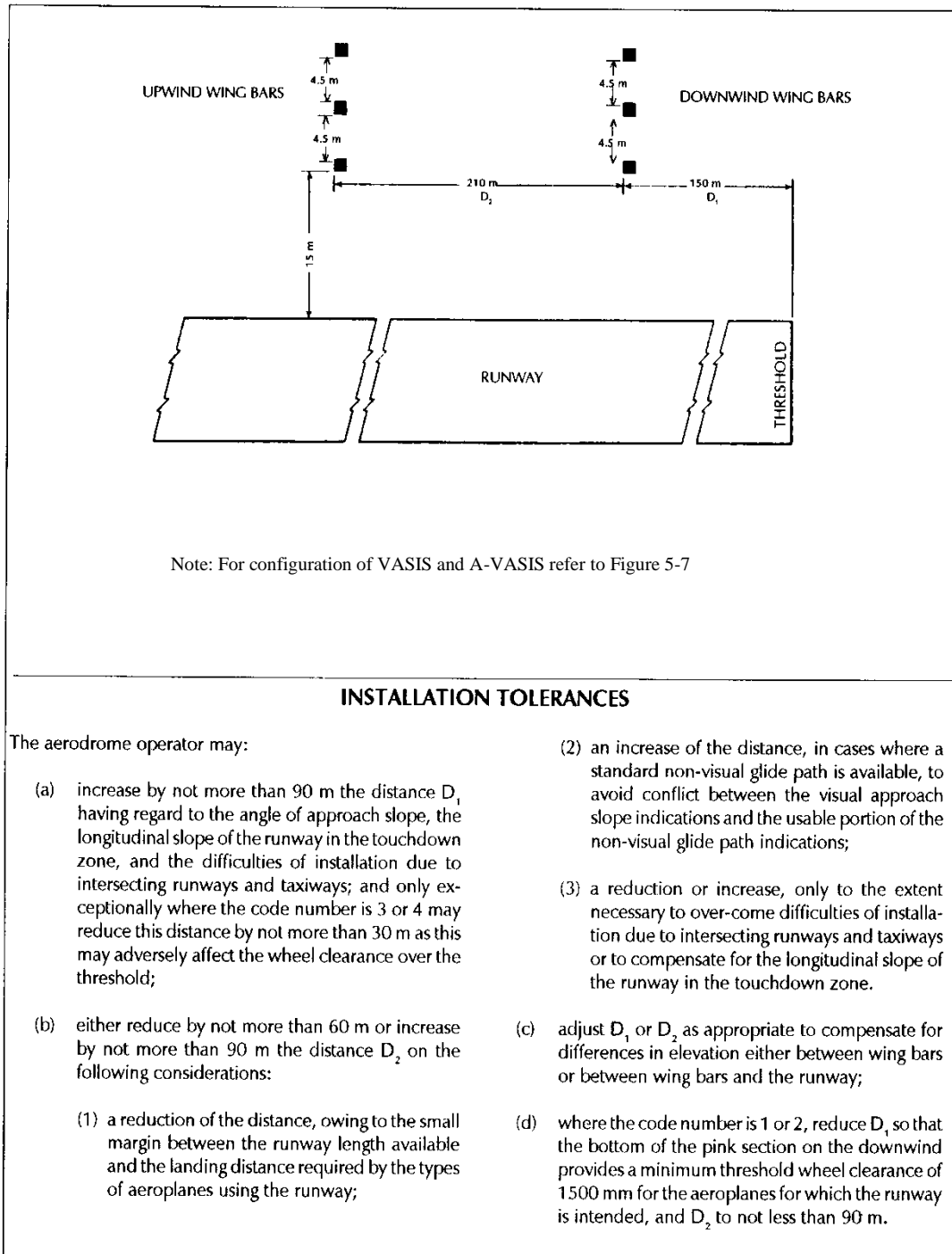

Figure 5-18. Installation of wing bars for VASIS and AVASIS

Characteristics of the light units

5.3.58 The system should be suitable for both day and night operations.

5.3.59 The light distribution of the beam of each light unit should be of a fan shape showing over a wide arc in azimuth in the approach direction. The colour transition from red to white in the vertical plane should be such as to appear to an observer at a distance to occur up to a vertical angle of approximately 15 minutes. The intensity of the completely red beam immediately

below the transition sector should not be less than 15% of the intensity of the completely white beam immediately above the transition sector.

Approximate limits are specified because of the subjective elements of observing the boundaries of the transition sector.

5.3.60 The beam of light produced by the light units should show through an angle of at least 1° and thirty minutes above and below the mean of the transition sector both by day and by night and an azimuth through at least 10° by day and 15° by night. The effective visual range of the system in clear weather over the above angles should be at least 7400 m for configurations (a) and (b) in Figure 5-16.

5.3.61 The beam of light produced by the light units should show from ground level up to twice the approach slope angle and have as great an intensity as possible over 30° in azimuth and 5° in elevation.

5.3.62 A suitable intensity control should be provided so as to allow adjustment to meet the prevailing conditions and to avoid dazzling the pilots during approach and landing.

5.3.63 Each light unit should be capable of adjustment in elevation so that the lower limit of the white part of the beam may be fixed at any desired angle of elevation between 1° 30 minutes and 4° 30 minutes above the horizontal.

5.3.64 The lights units should be so designed that deposits of condensation, dirt, and so on, on optically transmitting or reflecting surfaces should interfere to the least possible extent with the light signals and should in no way effect the contrast between the red and white signals and the elevation of the transition sector. The construction of the light units should be such as to minimise the probability of the slots being wholly or partially blocked by snow or ice where these conditions are likely to be encountered.

Approach slope and elevation setting of light units

5.3.65 The approach slope as defined in Figure 5-17 should be appropriate for use by the aeroplanes using the approach.

5.3.66 When a runway on which a VASIS is provided is equipped with an ILS, the siting and elevations of the light units should be such that the visual approach slope conforms as closely as possible to the glide path of the ILS. The angle of elevation setting of the lights in the downwind wing bars should be such that during an approach the pilot of an aeroplane receiving the lowest on-slope signal will clear all objects in the approach area by a safe margin.

Where an obstacle exists outside the approach area, the beam coverage of the light units may be suitably reduced in order to clear the obstacle.

5.3.67 The angle of elevation setting of the light beams in the upwind and downwind wing bars should be such that the angle D as shown in Figure 5-17 should preferably be about 15 minutes greater than, and should never be less than, the angle A.

5.3.68 The light beams in the upwind wing bars should all have the same angle of elevation setting. The light beams in the downwind wing bars should all have the same angle of elevation setting.

— T-VASIS and AT-VASIS

Description

5.3.69 The T-VASIS should consist of twenty light units symmetrically disposed about the runway centre line in the form of two wing bars of four lights each, with bisecting longitudinal lines of six lights, as shown in Figure 5-19.

5.3.70 The AT-VASIS should consist of ten light units arranged on one side of the runway in the form of a single wing bar of four light units with a bisecting longitudinal line of six lights.

5.3.71 The light units should be constructed and arranged in such a manner that the pilot of an aeroplane during an approach will:

- (a) when above the approach slope, see the wing bar(s) white, and one, two or three *fly-down* lights, the more *fly-down* lights being visible the higher the pilot is above the approach slope
- (b) when on the approach slope, see the wing bar(s) white
- (c) when below the approach slope, see the wing bar(s) white, and one, two or three *fly-up* lights, the more *fly-up* lights being visible the lower the pilot is above the approach slope; and when well below the approach slope, see the wing bar(s) and the three *fly-up* lights red.

5.3.72 When on or above the approach slope, no light should be visible from the *fly-up* light units; when on or below the approach slope, no light should be visible from the *fly-down* light units.

Siting

5.3.73 The light units should be located as shown in Figure 5-19, subject to the installation tolerances given therein.

*The siting of T-VASIS will provide, for a 3° slope and a nominal eye height over the threshold of 15 m (see paragraphs 5.3.69 and 5.3.83), a pilot eye height over threshold of 13m to 17m when only the wing bar lights are visible. If increased eye height at the threshold is required (to provide adequate wheel clearance), then the approaches may be flown with one or more **fly-down** lights visible. The pilot's eye height over the threshold is then of the following order:*

Wing bar lights and one <i>fly-down</i> light visible	17 m to 22 m
Wing bar lights and two <i>fly-down</i> lights visible	22 m to 28 m
Wing bar lights and three <i>fly-down</i> lights visible	28 m to 54 m

Characteristics of the light units

5.3.74 The system should be suitable for both day and night operations.

5.3.75 The light distribution of the beam of each light unit should be of a fan shape showing over a wide arc in the azimuth in the approach direction. The wing bar light units should produce a beam of white light from 1° 54 minutes vertical angle up to 6° vertical angle and a beam of red light from 0° to 1° 54 minutes vertical angle. The *fly-down* light units should produce a white beam extending from an elevation of 6° down to approximately the approach slope, where it

should have a sharp cut-off. The *fly-up* light units should produce a white beam from approximately the approach slope down to 1° 54 minutes vertical angle and a red beam below a 1° 54 minutes vertical angle. The angle of the top of the red beam in the wing bar units and *fly-up* units may be increased to ensure that, during an approach, the pilot of an aeroplane to whom the wing bar and three *fly-up* units are visible would clear all objects in the approach by a safe margin if any such light did not appear red.

5.3.76 The light intensity distribution of the *fly-down*, wing bar and *fly-up* light units should be as shown in Appendix 2, figure A2-22.

5.3.77 The colour transition from red to white in the vertical plane should be such as to appear to an observer, at a distance of not less than 300 m, to occur over a vertical angle of not more than 15 minutes.

5.3.78 At full intensity the red light should have a Y coordinate not exceeding 0.320.

5.3.79 A suitable intensity control should be provided to allow adjustments to meet the prevailing conditions and to avoid dazzling the pilot during approach and landing.

5.3.80 The light units forming the wing bars, or the light units forming a *fly-down* or *fly-up* matched pair, should be mounted so as to appear to a pilot of an approaching aeroplane to be in a substantially horizontal line. The light units should be mounted as low as possible and should be sufficiently light and frangible not to constitute a hazard to aeroplanes.

5.3.81 The light units should be so designed that deposits of condensation, dirt, and suchlike on optically transmitting or reflecting surfaces should interfere to the least possible extent with the light signals and should in no way effect the elevation of the beams or contrast between the red and white signals. The construction of the light units should be such as to minimise the probability of the slots being wholly or partially blocked by snow or ice where these conditions are likely to be encountered.

Approach slope and elevation setting of the light beams.

5.3.82 The approach slope should be appropriate for use by the aeroplanes using the approach.

5.3.83 When the runway on which a T-VASIS is provided is equipped with an ILS, the siting and elevations of the light units should be such that the visual approach slope conforms closely to the glide path of the ILS.

5.3.84 The elevation of the beams of the wing bar light units on both sides of the runway should be the same. The elevation of the top of the beam of the *fly-up* light unit nearest to each wing bar, and that of the *fly-down* unit nearest to each wing bar, should be equal and should correspond to the approach slope. The cut-off angle of the top of the beams of successive *fly-up* light units should decrease by 5 minutes of arc in angle of elevation at each successive unit away from the wing bar. The cut-in angle of the bottom beam of the *fly-down* light units should decrease by 7 minutes of arc at each successive unit away from the wing bar (see Figure 5-20).

5.3.85 The elevation setting of the top of the red light beams of the wing bar and the *fly-up* units should be such that, during an approach, the pilot of an aeroplane to whom the wing bar and three *fly-up* light units are visible would clear all objects in the approach area by a safe margin if any such light did not appear red.

5.3.86 The azimuth spread of the light beam should be suitably restricted where an object located outside the obstacle protection surface of the system, but within the lateral limits of its light beam, is found to extend above the plane of the obstacle protection surface and an

aeronautical study indicates that the object could adversely affect the safety of operations. The extent of the restriction should be such that the object remains outside the confines of the light beam.

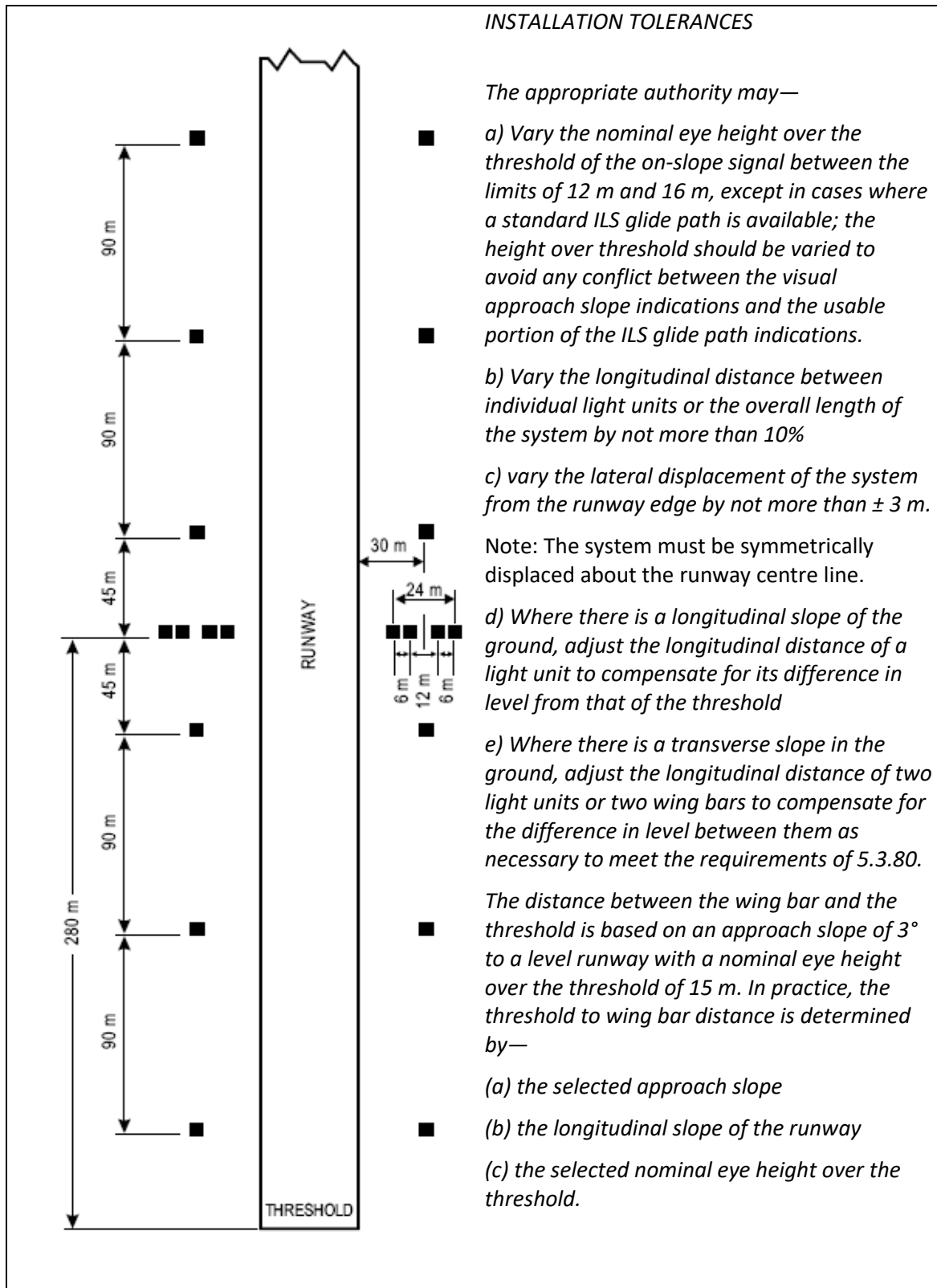

Figure 5-19. Installation of light units for T-VASIS

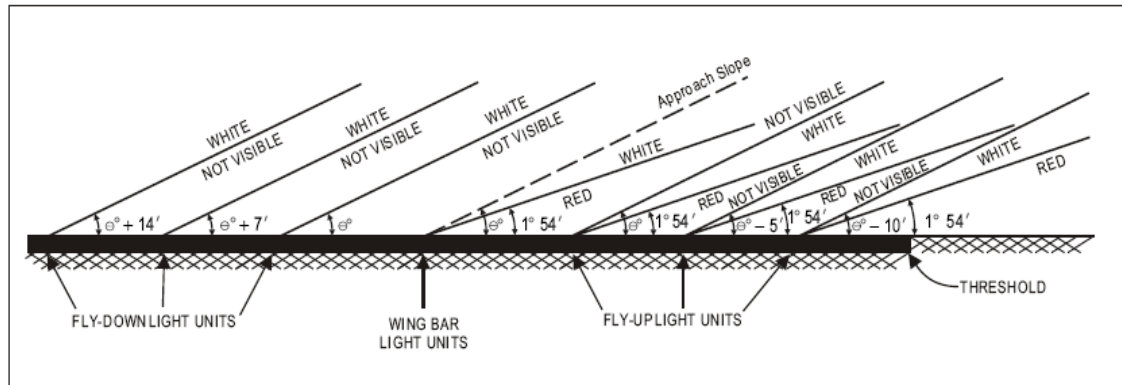

Figure 5-20. Light beams and elevation settings of T-VASIS and AT-VASIS

— PAPI and APAPI

Description

5.3.87 The PAPI system should consist of a wing bar of four sharp transition multi-lamp (or paired single lamp) units equally spaced. The system should be located on the left side of the runway unless it is physically impracticable to do so.

5.3.88 The APAPI system should consist of a wing bar of two sharp transition multi-lamp (or paired single lamp) units. The system should be located on the left side of the runway unless it is physically impracticable to do so.

For both systems, where a runway is used by aircraft requiring visual roll guidance which is not provided by other external means, then a second wing bar may be provided on the opposite side of the runway.

5.3.89 The wing bar of a PAPI should be constructed and arranged in such a manner that the pilot making an approach will:

- when on or close to the approach slope, see the two units nearest the runway as red, and the two units farthest from the runway as white
- when above the approach slope, see the one unit nearest the runway as red and the three units farthest from the runway as white; and when further above the approach slope, see all the units as white
- when below the approach slope, see the three units nearest the runway as red and the unit farthest from the runway as white; and when further below the approach slope, see all the units as red.

5.3.90 The wing bar of an APAPI should be constructed and arranged in such a manner that the pilot making an approach will:

- when on or close to the approach slope, see the unit nearer the runway as red and the unit farther from the runway as white
- when above the approach slope, see both the units as white

- (c) when below the approach slope, see both the units as red.

Siting

5.3.91 The light units should be located as in the basic configuration illustrated in Figure 5-21 subject to the installation tolerances given therein. The units forming a wing bar should be mounted so as to appear to the pilot of an approaching aeroplane to be substantially in a horizontal line. The light units should be mounted as low as possible and should be sufficiently light and frangible not to constitute a hazard to aeroplanes.

Characteristics of the light units

5.3.92 The system should be suitable for both day and night operations.

5.3.93 The colour transition from red to white in the vertical plane should be such as to appear to an observer, at a distance of not less than 300 m, to occur within a vertical angle of not more than 3 minutes.

5.3.94 At full intensity the red light should have a Y coordinate not exceeding 0.320.

5.3.95 The light intensity distribution of the light units should be as shown in Figure 5-22.

5.3.96 Suitable intensity control should be provided so as to allow adjustment to meet the prevailing conditions and to avoid dazzling the pilot during approach and landing.

5.3.97 Each light unit should be capable of adjustment in elevation so that the lower limit of the white part of the beam may be fixed at any desired angle of elevation between 1° 30 minutes and at least 4° 30 minutes above the horizontal.

5.3.98 The light units should be so designed that deposits of condensation, snow, ice, dirt, and suchlike on optically transmitting or reflecting surfaces should interfere to the least possible extent with the light signals and should not affect the contrast between the red and white signals and the elevation of the transition sector.

Approach slope and elevation setting of the light units

5.3.99 The approach slope as defined in Figure 5-23 should be appropriate for use by the aeroplanes using the approach.

5.3.100 Where the runway is equipped with an ILS, the siting and the angle of elevation of the light units should be such that the visual approach slope conforms as closely as possible to the glide path of the ILS.

5.3.101 The angle of elevation settings of the light units in a PAPI wing bar should be such that, during an approach, the pilot of an aeroplane observing a signal of one white and three reds will clear all objects in the approach area by a safe margin.

5.3.102 The angle of elevation settings of the light units in an APAPI wing bar should be such that, during an approach, the pilot of an aeroplane observing the lowest on slope signal, that is one white and one red, will clear all objects in the approach area by a safe margin.

5.3.103 The azimuth spread of the light beam should be suitably restricted where an object located outside the obstacle protection surface of the PAPI or APAPI system, but within the lateral limits of its light beam, is found to extend above the plane of the obstacle protection surface and an aeronautical study indicates that the object could adversely affect the safety of operations. The

extent of the restriction should be such that the object remains outside the confines of the light beam.

5.3.104 Where wing bars are installed on each side of the runway to provide roll guidance, corresponding units should be set the same angle so that the signals of each wing bar change symmetrically at the same time.

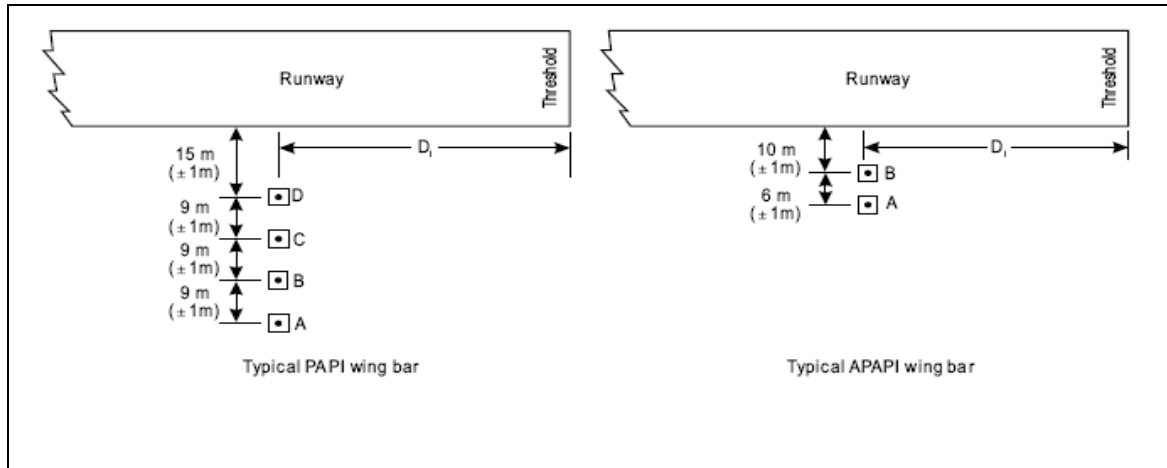

(a) Where a PAPI or APAPI is installed on a runway not equipped with an ILS, the distance D1 should be calculated to ensure that the lowest height at which a pilot will see a correct approach path indication (Figure 5-23, angle B for a PAPI and angle A for an APAPI) provides the wheel clearance over the threshold specified in Table 5-2 for the most demanding amongst aeroplanes regularly using the runway.

(b) Where a PAPI or APAPI is installed on a runway equipped with an ILS, the distance D1 should be calculated to provide the optimum compatibility between the visual and non-visual aids for the range of eye-to-antenna heights of the aeroplanes regularly using the runway. The distance should be equal to that between the threshold and the effective origin of the ILS glide path or MLS minimum glide path, as appropriate, plus a correction factor for the variation of eye-to-antenna heights of the aeroplanes concerned. The correction factor is obtained by multiplying the average eye-to-antenna height of those aeroplanes by the cotangent of the approach angle. However, the distance should be such that in no case will the wheel clearance over the threshold be lower than that specified in column (3) of Table 5-2.

Note: See paragraph 5.2.28 for specifications on aiming point marking. Guidance on the harmonization of PAPI and ILS signals is contained in the *Aerodrome Design Manual (ICAO Doc 9157), Part 4*.

(c) If a wheel clearance, greater than that specified in (a) above is required for specific aircraft, this can be achieved by increasing D1.

(d) Distance D1 should be adjusted to compensate for differences in elevation between the lens centres of the light units and the threshold.

(e) To ensure that units are mounted as low as possible and to allow for any transverse slope, small height adjustments of up to 5 cm between units are acceptable. A lateral gradient not greater than 1.25% can be accepted provided it is uniformly applied across the units.

(f) A spacing of 6 m (±1 m) between PAPI units should be used on code numbers 1 and 2. In such an event, the inner PAPI unit should be located not less than 10 m (±1 m) from the runway edge.

Note: Reducing the spacing between light units results in a reduction in usable range of the system.

(g) The lateral spacing between APAPI units may be increased to 9 m (±1 m) if greater range is required or later conversion to a full PAPI is anticipated. In the latter case, the inner APAPI unit should be located 15 m (±1 m) from the runway edge.

Figure 5-21 Installation of PAPI and APAPI

Table 5-2. Wheel clearance over threshold for PAPI and APAPI

Eye-to-wheel height of aeroplane in the approach configuration (1)	Metres Notes b & c (2)	Metres Note d (3)
Up to but not including 3 m	6	3 Note e
3 m up to but not including 5 m	9	4
5 m up to but not including 8 m	9	5
8 m up to but not including 14 m	9	6
<p>(a) <i>In selecting the eye-to-wheel height group, only aeroplanes meant to use the system on a regular basis should be considered. The most demanding amongst such aeroplanes should determine the eye-to-wheel height group.</i></p> <p>(b) <i>Where practicable the desired wheel clearances shown in column (2) should be provided.</i></p> <p>(c) <i>The wheel clearances in column (2) may be reduced to no less than those in column (3) where an aeronautical study indicates that such reduced wheel clearances are acceptable.</i></p> <p>(d) <i>When a reduced wheel clearance is provided at a displaced threshold it should be ensured that the corresponding desired wheel clearance specified in column (2) will be available when an aeroplane at the top end of the eye-to-wheel height group chosen over flies the extremity of the runway.</i></p> <p>(e) <i>This wheel clearance may be reduced to 1.5 m on runways used mainly by light-weight non-turbojet aeroplanes.</i></p>		

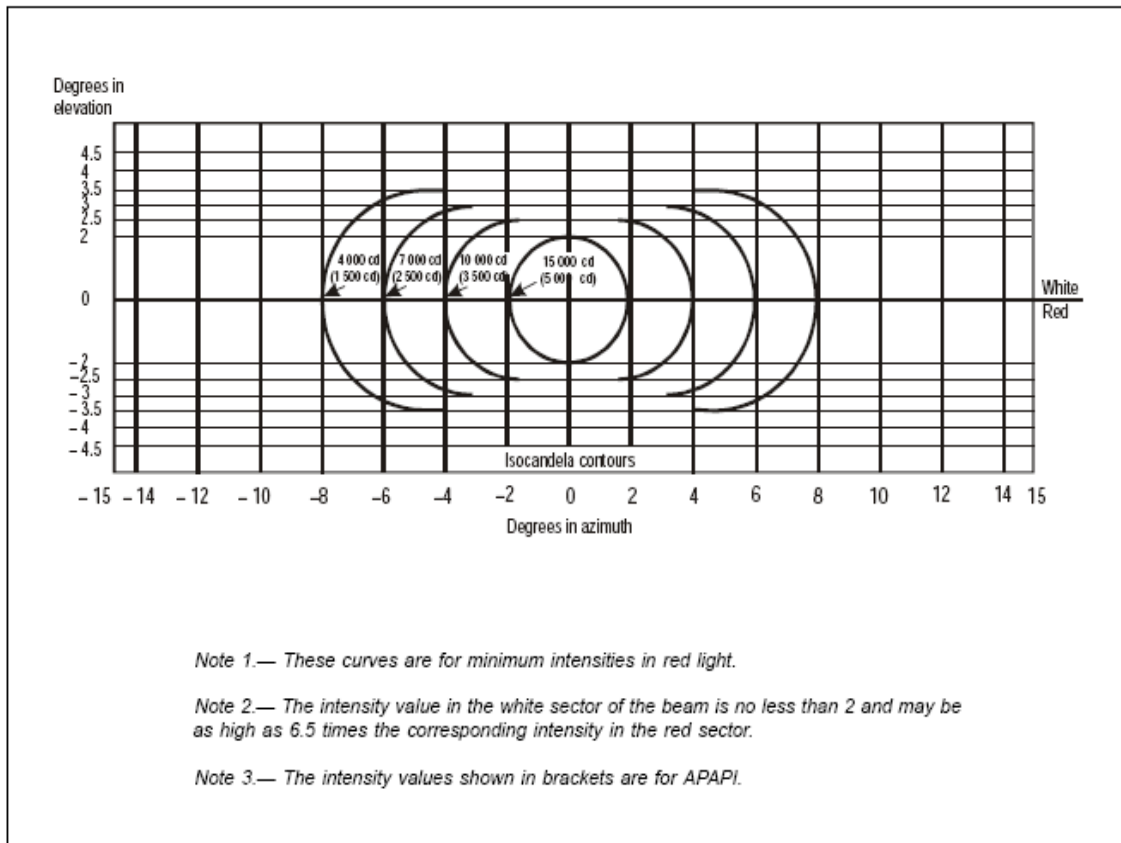

Figure 5-22. Light intensity distribution of PAPI and APAPI

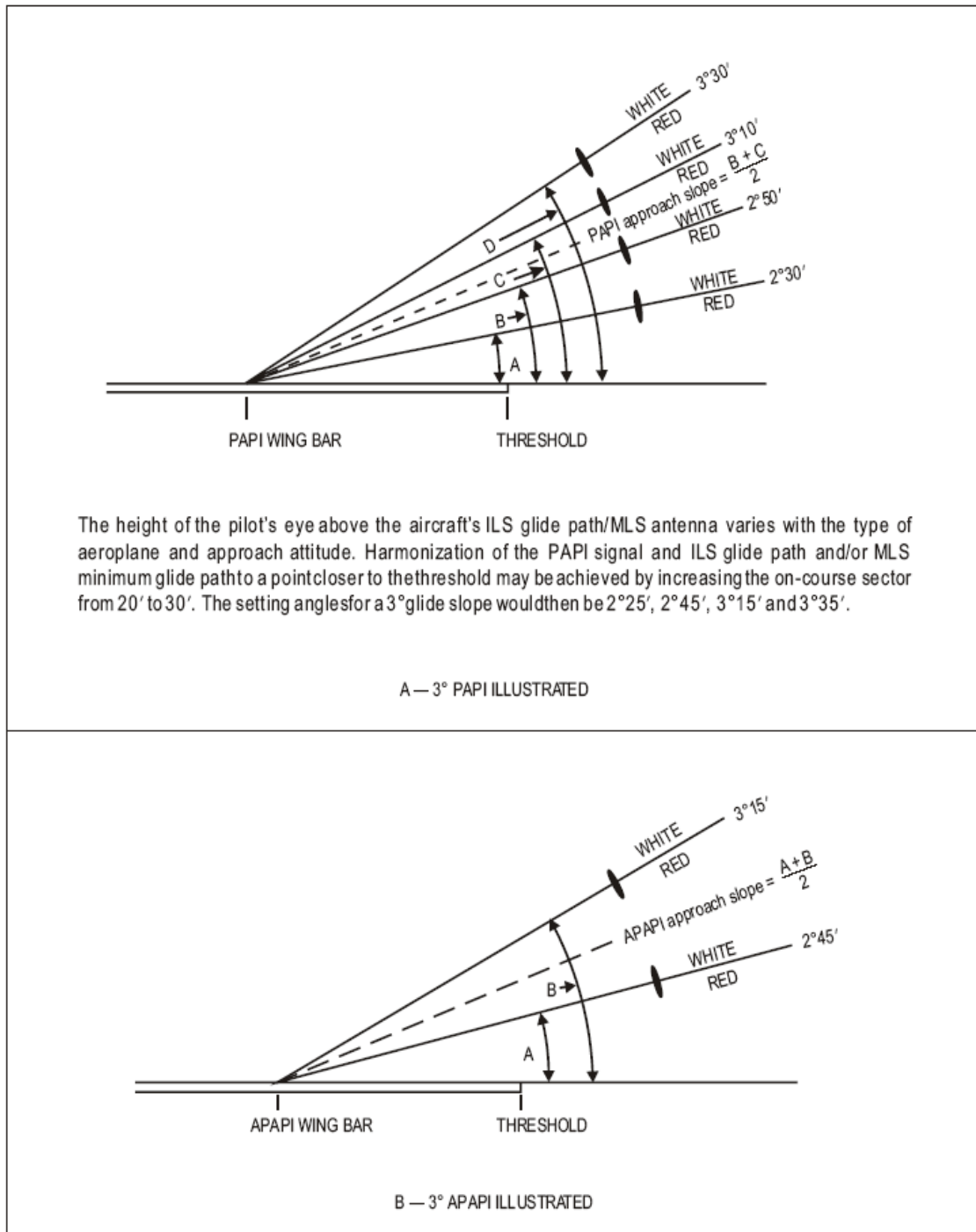

Figure 5-23. Light beams and angle of elevation setting of PAPI and APAPI

— **Obstacle protection surface**

The rule requirements for obstacle protection surface are contained in Part 139, Appendix E.3.8.

The following specifications apply to T-VASIS, AT-VASIS, PAPI and APAPI.

5.3.105 An obstacle protection surface must be established when it is intended to provide a visual approach slope indicator system.

5.3.106 The characteristics of the obstacle protection surface, i.e. origin, divergence, length and slope should correspond to those specified in the relevant column of Table 5-3.

5.3.107 New objects or extensions of existing objects are not permitted above an obstacle protection surface unless the new object or extension is shielded by an existing immovable object.

Circumstances in which the shielding principle may reasonably be applied are described in section 4, subsection 4.4.

5.3.108 Existing objects above an obstacle protection surface should be removed unless the object is shielded by an immovable object, or after aeronautical study it is determined that the object would not adversely affect the safety of operations of aeroplanes.

5.3.109 Where an aeronautical study indicates that an existing object extending above an obstacle protection surface could adversely affect the safety of operations of aeroplanes one or more of the following measures must be taken:

- (a) suitably raise the approach slope of the system:
- (b) reduce the azimuth spread of the system so that the object is outside the confines of the beam:
- (c) displace the axis of the system and its associated obstacle protection surface by no more than 5°:
- (d) suitably displace the threshold:
- (e) where (d) is found to be impracticable, suitably displace the system upwind of the threshold to provide an increase in crossing height equal to the height of the object penetration.

— **Wind direction indicators**

Application

5.3.110 A runway intended to be used at night should have one illuminated wind direction indicator (windsock) adjacent to each threshold.

Table 5-3. Dimensions and slopes of the obstacle protection surface

Surface dimensions	Runway type/code number							
	Non-instrument Code number				Instrument Code number			
	1	2	3	4	1	2	3	4
Length of inner edge	60 m	80 m ^a	150 m	150 m	150 m	150 m	300 m	300 m
Distance from threshold	30 m	60 m	60 m	60 m	60 m	60 m	60 m	60 m
Divergence (each side)	10%	10%	10%	10%	15%	15%	15%	15%
Total length (m)	7500	7500 ^b	15 000	15 000	7500	7500 ^b	15 000	15 000
Slope								
(a) T-VASIS and AT-VASIS	— ^c	1°54'	1°54'	1°54'	—	1°54'	1°54'	1°54'
(b) PAPI ^d	—	A-34'12"	A-34'12"	A-34'12"	A-34'12"	A-34'12"	A-34'12"	A-34'12"
(c) APAPI ⁱ	A-54'	A-54'	—	—	A-54'	A-54'	—	—
<p>(a) This length is to be increased to 150 m for a T-VASIS or AT-VASIS.</p> <p>(b) This length is to be increased to 15000 m for a T-VASIS or AT-VASIS.</p> <p>(c) No slope has been specified if a system is unlikely to be used on runway type/code number indicated.</p> <p>(d) Angles as indicated in Figure 5-23.</p>								

— Circling guidance lights

Application

5.3.111 Circling guidance lights should be provided when existing approach and runway lighting systems do not satisfactorily permit identification of the runway or approach area, or both, to a circling aircraft. These lights are used, where terrain or obstructions restrict the circuiting area, or where the need exists to provide a clear indication of the landing threshold during the latter part of the downwind leg, the base leg or on the final approach.

Location

5.3.112 The location and number of lights should be adequate to enable the pilot to—

- join the downwind leg or align and adjust his track to the runway at a required distance from it and to distinguish the threshold in passing
- keep in sight the runway threshold or other features, or both, which will enable him to judge his turn on to base leg and final approach, taking into account the guidance of other visual aids.

5.3.113 Circling guidance lights should consist of:

- (a) lights indicating the extended centre line of the runway or parts of any approach lighting system, or both:
- (b) lights indicating the position of the runway threshold; or
- (c) lights indicating the direction or location of the runway; or
- (d) a combination of (a), (b), (c) above, as is appropriate to the runway under consideration.

Characteristics

5.3.114 Circling guidance lights should be amber in colour and may be either fixed or flashing. They should be of an intensity and beam spread adequate for the conditions of visibility and ambient light in which it is intended to make visual circling approaches.

5.3.115 The lights should be designed and be installed in such a manner that they will not dazzle or confuse a pilot when approaching to land, taking off or taxiing.

— Runway lead-in light system

Application

5.3.116 A runway lead-in lighting system should be provided where it is desired to provide visual guidance along a specific approach path, for reasons such as avoiding hazardous terrain or for noise abatement. They may also be used to provide take-off flight path guidance.

Location

5.3.117 Lead-in lights should be positioned so as to define a specific approach path and so that one light may be sighted from the preceding light. The interval between the lights should not be greater than 1600 m. Lead-in lighting may be curved, straight, or a combination thereof.

5.3.118 Lead-in lights should extend up to a point where the approach lighting system, if provided, or the runway or the runway lighting system is in view.

Characteristics

5.3.119 The main lights of lead-in lighting should be fixed intensity and be red in colour. The line of lead-in lights should be provided either with 2 amber portal beacons at the outer limit of the line or the outermost light of the line will be amber coloured. These outer limit lights may be either fixed or flashing.

— Runway threshold identification lights

Application

5.3.120 Runway threshold identification lights should be installed adjacent to the threshold of a runway in cases where, due to surrounding lighting, there is a need for additional threshold conspicuity and the normal type of approach lighting is not practicable.

Location

5.3.121 Runway threshold identification lights should be located symmetrically about the runway centre line, in line with the threshold and approximately 10 m outside each line of runway edge lights.

Characteristics

5.3.122 Runway end identification lights should be high intensity, white capacitor discharge lights and should be visible only in the direction of approach to the runway. The flash frequency should be 60 to 120 per minute.

— Runway edge lights

The rule requirements for runway edge lights are contained in Part 139, Appendix E.3.9.

Application

5.3.123 Runway edge lights must be provided for a runway

- intended for use at night
- for a precision approach runway intended for use by day or night.

Runway edge lights should be provided for a runway intended for take-off with an operating minima below an RVR of the order of 800 m by day.

Location

5.3.124 Runway edge lights should be placed along the full length of the runway and should be in two parallel rows equidistant from the centre line. They should be placed along the edges of the area declared for use as the runway or outside the edges of the area by no more than 3 m. The lights should be uniformly spaced in rows at intervals of not more than 60 m for an instrument runway, and at intervals of not more than 100 m for a non-instrument runway. The lights on opposite sides of the runway axis should be on lines at right angles to that axis. At intersections of runways, lights may be spaced irregularly or omitted, provided that adequate guidance remains available to the pilot.

5.3.125 Where the width of the area which could be declared as runway exceeds 60 m, the distance between the rows of lights should be determined taking into account the nature of the operations, the light distribution characteristics of the runway edge lights, and other visual aids serving the runway.

Characteristics

5.3.126 Runway edge lights should be fixed omnidirectional lights showing variable white, except that:

- (a) in the case of a displaced threshold, the lights between the beginning of the runway and the displaced threshold should be unidirectional red and white showing red in the direction of approach
- (b) a section of the lights 600 m or one-third of the runway length, whichever is the less, at the remote end of the runway from the end at which the take-off run is started, may show yellow.

5.3.127 The lights should show at angles up to 15° above the horizontal with an intensity adequate for the conditions of visibility and ambient light in which use of the runway for take-off or landing is intended. In any case, the intensity should be at least 50 cd except that at an aerodrome without extraneous lighting the intensity of the lights may be reduced to not less than 25 cd to avoid dazzling the pilot. The light fittings should normally be elevated except flush fitting should be installed where the lights lie within areas of runway and taxiway or turning bay intersections or within areas of other runways.

— **Runway threshold and wing bar lights**

The rule requirements for runway threshold and wing bar lights are contained in Part 139, Appendix E.3.10.

Application

5.3.128 Runway threshold lights must be provided for a runway equipped with runway edge lights except on a non-instrument or non-precision approach runway where the threshold is displaced and wing bar lights are provided.

Wing bar lights must be provided on a non- instrument or non-precision approach runway where the threshold is displaced and runway threshold lights are required, but are not provided.

Location

5.3.129 When a threshold is at the extremity of a runway, the threshold lights should be placed in a row at right angles to the runway axis as near to the extremity of the runway as possible and, in any case, not more than 3 m outside the extremity.

5.3.130 When a threshold is displaced from the extremity of a runway, threshold lights should be placed in a row at right angles to the runway at the displaced threshold.

5.3.131 Threshold lighting should consist of:

- (a) on a runway operated to precision approach category II or III minima, lights uniformly spaced between the rows of runway edge lights at intervals of not more than 3 m.
- (b) on a runway operated to precision approach category I minima, at least the number of lights that would be required if the lights were uniformly spaced at intervals of 3 m between the rows of runway edge lights.
- (c) on all other runways at least 6 lights.

The lights prescribed in (a) and (b) should be either:

- (a) equally spaced between the rows of runway edge lights; or*
- (b) symmetrically disposed about the runway centre line in two groups with the lights equally spaced in each group and with a gap between the groups of not more than half the runway width.*

Characteristics

5.3.132 Runway threshold lights should be fixed unidirectional lights showing green in the direction of approach to the runway. The intensity and beam spread of the lights should be adequate for the conditions of visibility and ambient light in which use of the runway is intended. The fittings may be elevated.

Application of wing bar lights

5.3.133 Wing bar lights should be provided on a precision approach runway when additional conspicuity is desirable.

5.3.134 Wing bar lights should be provided on a non-instrument or non-precision approach runway where the threshold is displaced and runway threshold lights are required, but are not provided.

Location of wing bar lights

5.3.135 Wing bar lights should be symmetrically disposed about the runway centre line at the threshold in two groups of wing bars with 5 lights spaced at 3 m intervals with the inner light in line with the runway edge light.

Characteristics of wing bar lights

5.3.136 Wing bar lights should be fixed unidirectional lights showing green in the direction of approach to the runway. The intensity and beam spread of the lights should be adequate for the conditions of visibility and ambient light in which use of the runway is intended.

— Runway end lights

The rule requirements for runway end lights are contained in Part 139, Appendix E.3.9.

Application

5.3.137 Runway end lights must be provided for a runway equipped with runway edge lights.

When a threshold is at the end of the runway, fittings serving as threshold lights may be used as runway end lights.

Location

5.3.138 Runway end lights should be placed on a line at right angles to the runway axis as near to the end of the runway as possible and, in any case, not more than 3 m outside the end.

5.3.139 Runway end lights should comprise of at least 6 lights either:

- (a) Equally spaced between the rows of runway edge lights.
- (b) Symmetrically disposed about the runway centre line in two groups with the lights being uniformly spaced in each group and with a gap between the groups of not more than half the runway width. The outer lights should be in line with the runway edge lights.

For a runway operated to precision approach category III minima, the spacing between runway end lights, except between the two innermost lights if a gap is used, should not exceed 6 m.

Characteristics

5.3.140 Runway end lights should be fixed unidirectional lights showing red towards an aircraft taking off from the runway. The intensity and beam spread of the lights should be adequate for the conditions of visibility and ambient light in which use of the runway is intended. The fittings may be the elevated type.

— Runway centre line lights

The rule requirements for runway centre line lights are contained in Part 139, Appendix E.3.11.

Application

5.3.141 Runway centre line lights must be provided:

- (a) on a precision approach runway category II or III
- (b) on a on a runway intended to be used for take-off with an operating minimum below an RVR of 400 m.

Runway centre line lights should be provided:

- (a) on a precision approach category I runway particularly when the runway is used by aircraft with high landing speeds or where the width between the runway edge lights is greater than 50 m
- (b) on a runway intended to be used for take-off with an operating minimum of an RVR above 400 m when used by aeroplanes with a very high take-off speed, particularly where the width between the runway edge lights is greater than 50 m.

Location

5.3.142 Runway centre line lights should be located along the centre line of the runway, except that the lights may be uniformly offset to the same side of the centre line by not more than 0.6 m where it is not practicable to locate them along the centre line. The lights should be located from the threshold to the end of the runway at a longitudinal spacing of approximately:

- (a) 7.5 m or 15 m for a precision approach runway category III
- (b) 7.5 m, 15 m or 30 m on a precision approach runway category II or other runway on which the lights are provided.

Characteristics

5.3.143 Runway centre line lights should be fixed flush lights showing variable white from the threshold to a point 900 m from the runway end; alternate red and variable white from 900 m to 300 m from the runway end; and red from 300 m to the runway end, except that:

- (a) where the runway centre line lights are spaced at 7.5 m intervals, alternate pairs of red and variable white lights should be used on the section from 900 m to 300 m from the runway end
- (b) for runways less than 1800 m in length, the alternate red and variable white lights should extend from the mid-point of the runway useable for landing to 300 m from the runway end.

Care is required in the design of the electrical system to ensure that failure of part of the electrical system will not result in a false indication of the runway distance remaining.

5.3.144 This coded pattern should show only for an aircraft moving on the runway in the appropriate direction.

— Runway touchdown zone lights

The rule requirements for runway touchdown zone lights are contained in Part 139, Appendix E.3.12.

Application

5.3.145 Touchdown zone lights must be provided in the touchdown zone of a precision approach runway category II or III.

Location

5.3.146 Touchdown zone lights should extend from the threshold for a longitudinal distance of 900 m or to the mid-point of the runway, whichever is less. The pattern should be formed by pairs of barrettes symmetrically located about the runway centre line. The lateral spacing between the innermost lights of a pair of barrettes should be equal to the lateral spacing of the touchdown

zone marking. The longitudinal spacing between the pairs of barrettes should be 30 m or 60 m depending on the visibility minima.

Characteristics

5.3.147 Touchdown zone lights should be fixed unidirectional lights showing variable white in the form of a barrette composed of 3 lights with a spacing of not more than 1.5 m between the lights. The barrette should not be less than 3 m nor more than 4 m in length.

— **Runway touchdown zone limit lights**

Application

5.3.148 The touchdown zone limit lights define the limit of the touchdown zone area for specific aircraft operations.

Location

5.3.149 Touchdown zone limit lights should be symmetrically disposed about the runway centreline at the touchdown zone limit point.

Characteristics

5.3.150 Touchdown zone limit lights should be in two groups of wing bars. Each wing bar should be formed by at least 5 lights extending at least 6 m outwards and at right angles to, the line of the runway edge lights, with the innermost light of each wing bar 4 m out from the line of the runway edge lights. The lights should be fixed unidirectional lights showing either all white or all green in the direction of approach to the runway. The intensity and beam spread should be adequate for the conditions of visibility and ambient light in which usage of the runway is intended. The lights should be independently controlled.

— **Stopway lights**

The rule requirements for stopway lights are contained in Part 139, Appendix E.3.13.

Application

5.3.151 Stopway lights must be provided for a stopway intended for use at night.

Location

5.3.152 Stopway lights should be located along the full length of the stopway. They should be in 2 parallel rows equidistant from the centre line and coincident with the rows of runway edge lights. Across the end of the stopway there should be 9 lights equally spaced for a precision approach runway category I, II or III, or at least 6 lights for other runways.

Characteristics

5.3.153 Stopway lights should be fixed unidirectional lights showing red towards aircraft taking off from the runway. The lights may be elevated type.

— **Starter extension edge lights**

Application

5.3.154 Starter extension edge lights should be provided for a starter extension intended for use at night.

Location

5.3.155 Edge lights should be placed along the edges of the full length of the starter extension, in two parallel rows equidistant from the centre line, or outside the edges of the area by no more

than 3 m. Where the starter extension is the same width as the associated runway the lights should be uniformly spaced in rows at intervals similar to the runway edge lights. Where the starter extension is a greater or lesser width than the associated runway the lights should be uniformly spaced in accordance with. The lights on opposite sides of the extension axis should be on lines at right angles to that axis.

Characteristics

5.3.156 Where the starter extension is the same width as the runway the edge lights should be fixed bi-directional lights showing red in the direction of approach and take-off. Where the starter extension is a greater or lesser width than the runway they should be fixed lights showing blue with the same characteristics as taxiway edge lights. Their brilliance need not be as great as that of the runway edge lights. The light fittings should normally be elevated except that flush fitting should be installed where the lights lie within areas of runway or taxiway-turning bays, or within areas of other runways.

— Starter extension end lights

Application

5.3.157 Runway end lights should be provided across the runway at the junction of the runway and starter extension for a runway equipped with runway edge lights.

5.3.158 Starter extension end lights should be provided across the end of a starter extension where the associated runway has runway edge lighting and it is intended to use the starter extension at night.

Location

5.3.159 The lights should be placed on a line at right angles to the runway axis as near to the end of the starter extension as possible and, in any case, not more than 3 m outside the end. They should comprise the following.

- (a) On starter extensions of the same width the runway, 6 lights equally spaced across the end of the starter extension. The outer lights should be in line with the runway edge lights.
- (b) On starter extensions that are not the same width as the associated runway, lights spaced at uniform intervals of not more than 30 m. The outer lights should be in line with the starter extension edge lights.

Characteristics

5.3.160 For a starter extension where the width is the same as the runway, the lights should be fixed unidirectional lights showing red towards the runway. For a starter extension where the width is not the same as the runway, the lights should be fixed unidirectional lights showing blue towards the runway. The intensity and beam spread of the lights should be adequate for the conditions of visibility and ambient light in which use of the runway is intended. The fittings may be the elevated type.

— Taxiway centre line lights

The rule requirements for taxiway centre line lights are contained in Part 139, Appendix E.3.14.

Application

5.3.161 Taxiway centre line lights must be provided on taxiways and aprons intended for use on aerodromes where the main runway is code number 4. The lights should provide continuous guidance from the runway centre line to a point on the apron where the aircraft commence manoeuvring for parking.

Location

5.3.162 Taxiway centre line lights should normally be located on the taxiway centre line marking, except that they may be offset by not more than 0.3 m where it is not practicable to locate them on the marking. Taxiway centre line lights on straight sections of taxiway should be spaced at intervals of 30 m except that at aerodromes with precision approach category III operations the spacing should be 15 m. A spacing of 60 m may be used where, because of prevailing meteorological conditions, adequate guidance is provided by such a spacing. On taxiway curves the spacing should be approximately 7.5 m.

5.3.163 Taxiway centre line lights on a high speed taxiway should commence at a point at least 60 m before the beginning of the taxiway centre line curve and continue beyond the end of the curve to a point on the centre line of the taxiway where an aeroplane can be expected to reach normal taxiing speed. The lights on that portion parallel to the runway centre line should always be at least 60 cm from any row of runway centre line lights.

Characteristics

5.3.164 Taxiway centre line lights on a taxiway other than an exit taxiway should be fixed lights showing green with beam dimensions such that the light is visible only from aeroplanes on or in the vicinity of the taxiway.

— Taxiway edge lighting

The rule requirements for taxiway edge lights are contained in Part 139, Appendix E.3.15.

Application

5.3.165 Taxiway edge lights must be provided at the edges of a runway turn pad, holding bay, de-icing/anti-icing facility, apron, etc., intended for use at night and on a taxiway not provided with taxiway centre line lights and intended for use at night. Taxiway edge lights need not be provided where, considering the nature of the operations, adequate guidance can be achieved by surface illumination or other means.

5.3.166 Taxiway edge lights must be provided on a runway forming part of a standard taxi-route and intended for taxiing at night where the runway is not provided with taxiway centre line lights.

Location

5.3.167 Taxiway edge lights on a straight portion of taxiway and on a runway forming part of a standard taxi-route should be spaced at uniform longitudinal spacing of not more than 60 m. The lights on a curve should be spaced at intervals less than 60 m so that a clear indication of the curve is provided

5.3.168 Taxiway edge lights on a holding bay, de-icing/anti-icing facility, apron, etc., should be spaced at uniform longitudinal intervals of not more than 60m.

5.3.169 Taxiway edge lights on a runway turn pad should be spaced at uniform longitudinal intervals of not more than 30m.

5.3.170 The lights should be located as near as practicable to the edges of the taxiway, runway turn-pad, de-icing/anti-icing facility, holding bay, apron or runway etc., or outside the edges at a distance of not more than 3 m.

Characteristics

5.3.171 Taxiway edge lights should be fixed lights showing blue. They should be omnidirectional and show up to at least 75° above the horizontal and at all angles in azimuth necessary to provide guidance to a pilot taxiing in either direction. At an intersection, exit or curve the lights should be shielded as far as practicable so they cannot be seen in angles of azimuth in which they may be confused with other lights. The light fittings should generally be elevated except that flush fittings should be installed where the edge lights lie within areas of runways or other taxiways. The intensity of taxiway edge lights should be at least 2 cd from 0° to 6° vertical, and 0.2 cd at any vertical angle between 6° and 75°.

— **Runway turn pad lights**

The rule requirements for runway turn pad lights are contained in Part 139, Appendix E.3.16.

Application

5.3.172 Runway turn pad lights must be provided for continuous guidance on a runway turn pad intended to be used at night to enable an aeroplane to complete a 180° turn and align with the runway centre line.

Location

5.3.173 Runway turn pad lights should normally be located on the runway turn pad marking, except that they may be offset by not more than 300 mm where it is not practicable to locate them on the marking. Runway turn pad markings on a straight section of the runway turn pad marking should be spaced at longitudinal intervals of not more than 15 m. Runway turn pad markings on a curved section of the runway turn pad marking should not exceed a spacing of 7.5 m.

Characteristics

5.3.174 Runway turn pad lights should be unit-directional fixed lights showing green with beam dimensions such that the light is visible only from aeroplanes on or approaching the runway turn pad.

— **Stop bars**

The rule requirements for stop bars are contained in Part 139, Appendix E.3.17.

Application

The provision of stop bars requires control either manually or automatically by air traffic services.

5.3.175 In addition to the rule requirements, stop bars should be provided at a runway-holding position used in conjunction with a precision approach runway category II or III or where it is desired to supplement or replace markings with lights and to provide traffic control by visual means.

5.3.176 Where the normal stop-bar lights may be obscured from the pilots view by the structure of the aircraft, then a pair of elevated lights should be added to each end of the stop bar.

Location

5.3.177 Stop bars should be located across the taxiway at the point where it is desired that traffic stop. Where the additional lights specified in paragraph 5.3.176 are provided, they should be located not less than 3 m from the taxiway edge.

Characteristics

5.3.178 Stop bars should consist of unidirectional lights spaced at intervals of 3 m across the taxiway, showing red in the direction of approach to the intersection or taxiway holding position.

5.3.179 The lighting circuit should be designed so that the lights may be switched on to indicate traffic should stop and switched off to indicate traffic should proceed.

5.3.180 Where additional lights specified in paragraph 5.3.176 are provided, these lights should have the same characteristics as the lights in the stop bar, but should be visible to approaching aircraft up to the stop bar position.

— **Intermediate holding position lights**

The rule requirements for intermediate holding position lights are contained in Part 139, Appendix E.3.18.

Application

5.3.181 Intermediate holding position lights must be provided at an intermediate holding position intended for use in runway visual range conditions less than a value of 350 m and at an intermediate holding position where there is no need for stop-and-go signals as provided by a stop bar.

Location

5.3.182 Intermediate holding position lights should be located along the intermediate holding position marking at a distance of 0.3 m prior to the marking.

Characteristics

5.3.183 Clearance bars should consist of at least three fixed unidirectional lights showing yellow in the direction of approach to the intersection with a light distribution similar the taxiway centre line lights if provided. The lights should be disposed symmetrically about, and at 90° to, the taxiway centre line lights, with individual lights spaced 1.5 m apart.

— **De-icing/anti-icing facility exit lights**

Application

5.3.184 De-icing/anti-icing facility exit lights should be provided at the exit boundary of a remote de-icing/anti-icing facility adjoining a taxiway.

Location

5.3.185 De-icing/anti-icing facility exit lights should be located 0.3 m inward of the intermediate holding position marking displayed at the exit boundary of a remote de-icing/anti-icing facility.

Characteristics

5.3.186 De-icing/anti-icing facility exit lights should consist of in-pavement fixed unidirectional lights spaced at intervals of 6 m showing yellow in the direction of the approach to the exit boundary with a light distribution similar to taxiway centre line lights (see Figure 5-24).

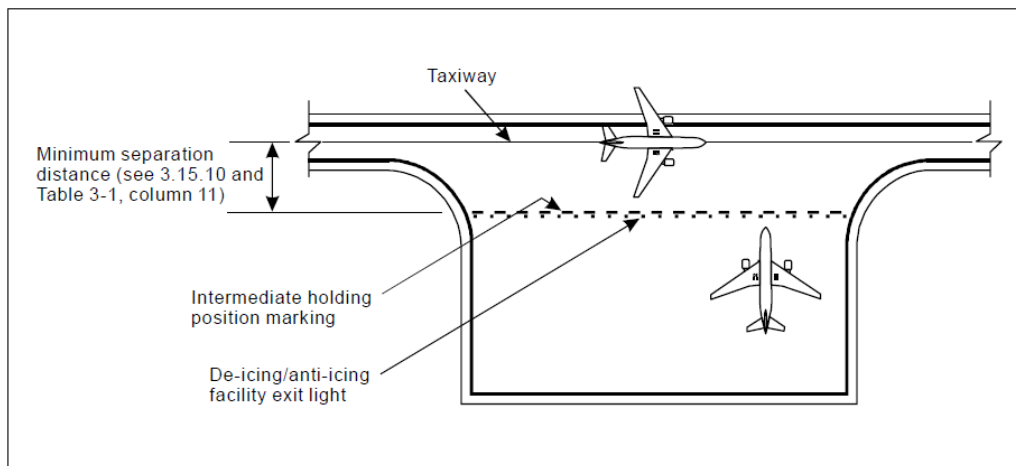

Figure 5-24. Typical remote de-icing/anti-icing facility

— Runway guard lights

The rule requirements for runway guard lights are contained in Part139, Appendix E.3.19.

Note: The purpose of runway guard lights is to warn pilots, and drivers of vehicles when they are operating on taxiways, that they are about to enter an active runway. There are two standard configurations of runway guard lights as illustrated in Fig 5-25.

Application

5.3.187 Runway guard lights must be provided at each taxiway/runway intersection associated with a runway intended for use in:

- (a) runway visual range conditions less than a value of 550 m where a stop bar is not installed
- (b) runway visual range conditions of values between 550 m and 1200m where the traffic density is heavy.

The lights should be configuration A.

5.3.188 Runway guard lights configuration A or B should be provided at each taxiway/runway intersection where enhanced conspicuity is needed, such as on a wide-throat taxiway, except that configuration B should not be collocated with a stop bar.

Location

5.3.190 Runway guard lights configuration A should be located at each side of the taxiway at a distance from the runway centre line not less than that specified for a take-off runway in Table 3-2.

5.3.191 Runway guard lights configuration B should be located across the taxiway at a distance from the runway centre line not less than that specified for a take-off runway in Table 3-2.

Characteristics

5.3.192 Runway guard lights configuration A should consist of 2 alternately illuminated yellow lights spaced 1 m apart. The light beam should be unidirectional and aligned so as to be visible to the pilot of an aeroplane taxiing to the taxi-holding position. The lights should be illuminated alternately between 30 and 60 cycles per minute. The light suppression and the illumination periods should be equal and opposite in each light.

5.3.193 Runway guard lights configuration B should consist of yellow lights spaced at intervals of 3 m across the taxiway. The light beam should be unidirectional and aligned so as to be visible to the pilot of an aeroplane taxiing to the taxi-holding position. The lights should be illuminated alternately and alternate lights should be illuminated in unison. The lights should be illuminated between 30 and 60 cycles per minute and the light suppression and the illumination periods should be equal and opposite in each light.

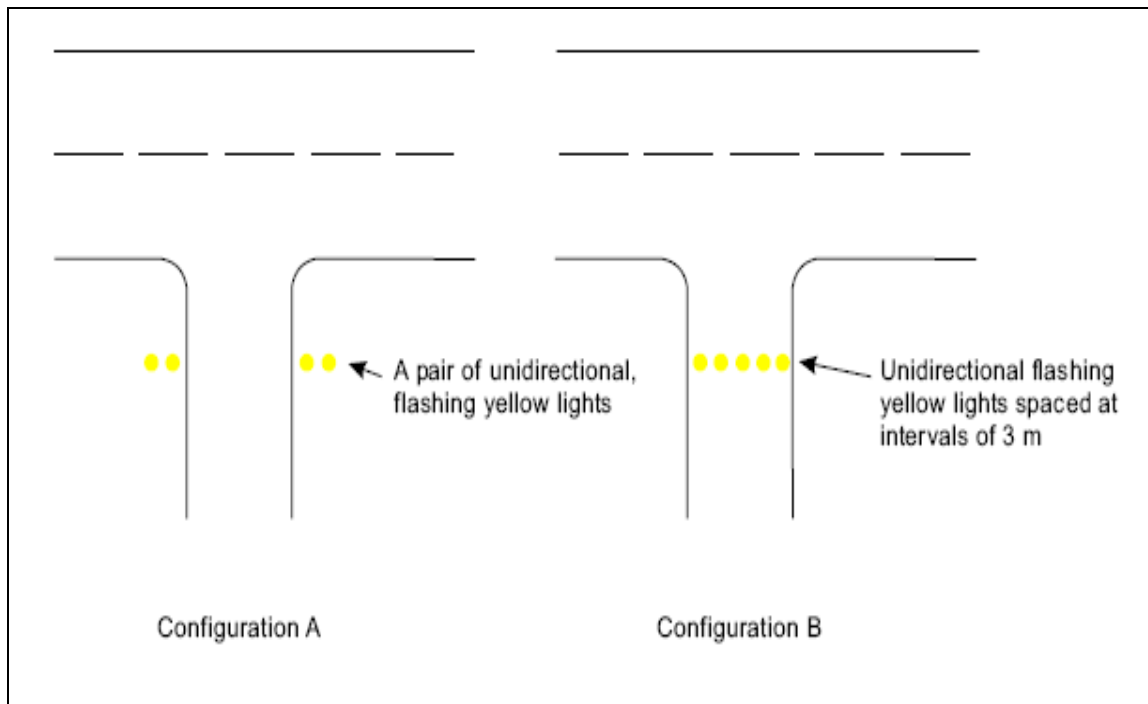

Figure 5-25. Runway guard lights

— **Apron floodlighting**

Application

5.3.194 Floodlighting should be provided on an apron, intended to be used at night.

Location

5.3.195 Apron floodlights should be located so as to provide adequate illumination on all apron service areas, with a minimum of glare to pilots of aircraft in flight and on the ground, aerodrome and apron controllers, and personnel on the apron. The arrangement and aiming of floodlights should be such that an aircraft stand receives light from two or more directions to minimise shadows (see Figures 5-26a and 5-26b).

5.3.196 To minimise direct and indirect glare (see Figure 5-27):

- (a) direct light above the horizontal plane should be restricted to a minimum
- (b) the mounting height of the floodlights should be at least twice the maximum aircraft eye height of pilots of aircraft regularly using the apron area.

Characteristics

5.3.197 Apron floodlights should be such that the colours used for aircraft marking connected with routine servicing, and for surface and obstacle marking, can be correctly identified.

5.3.198 The average illuminance should be at least the following.

- (a) Aircraft stand:
 - (i) horizontal illuminance — 20 lux with a uniformity ratio (average to minimum) of not more than 4 to 1
 - (ii) vertical illuminance — 20 lux at a height of 2 m above the apron in relevant directions.
- (b) Other apron areas:

horizontal illuminance — 50% of the average illuminance on the aircraft stands with a uniformity ratio (average to minimum) of not more than 4 to 1.

— **Isolated aircraft parking area floodlighting**

5.3.199 Lighting should not be of less than 15 lux measured on the aircraft parking spot, being of sufficient intensity to render any person approaching an aircraft clearly visible to the naked eye from a distance of 200 m.

5.3.200 The use of lighting which is sensor activated when any aircraft is approached is acceptable, provided that:

- (a) all approaches to the affected aircraft are covered by the sensors
- (b) the sensors are tamper proof
- (c) instant lighting is provided. Vapour filled lights requiring a warm-up period is not suitable in such situations.

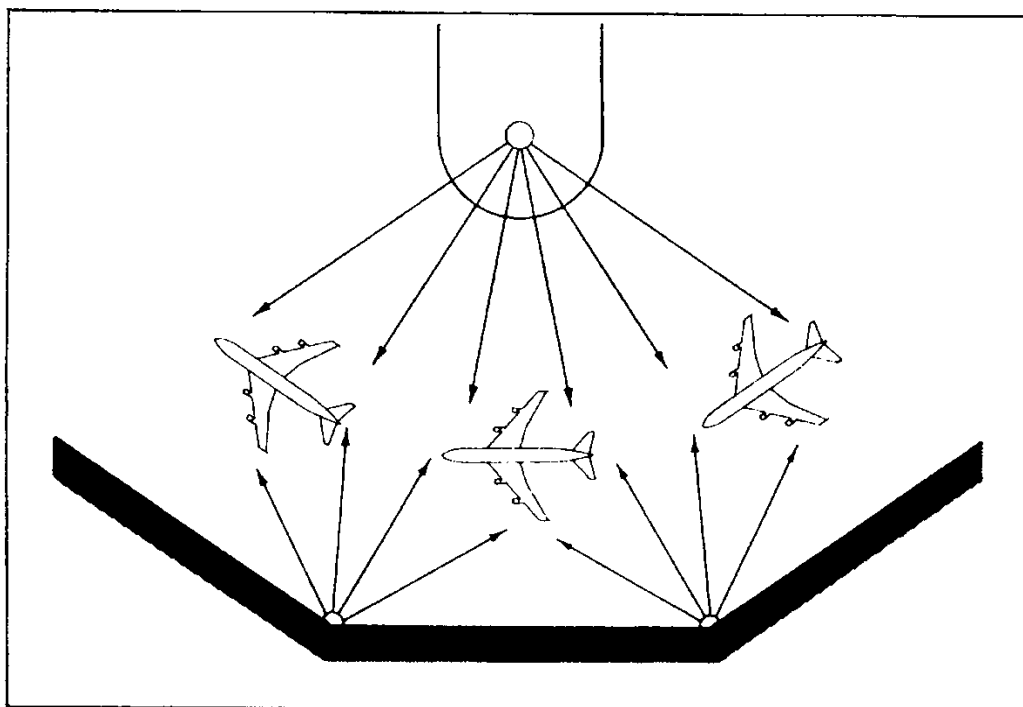

Figure 5-26a. Typical arrangement and aiming of parallel parking

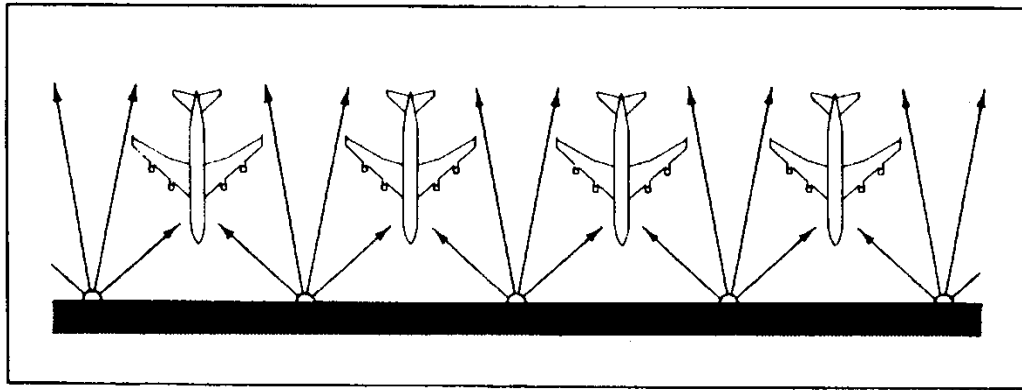

Figure 5-26b. Typical arrangement and aiming for nose-in parking

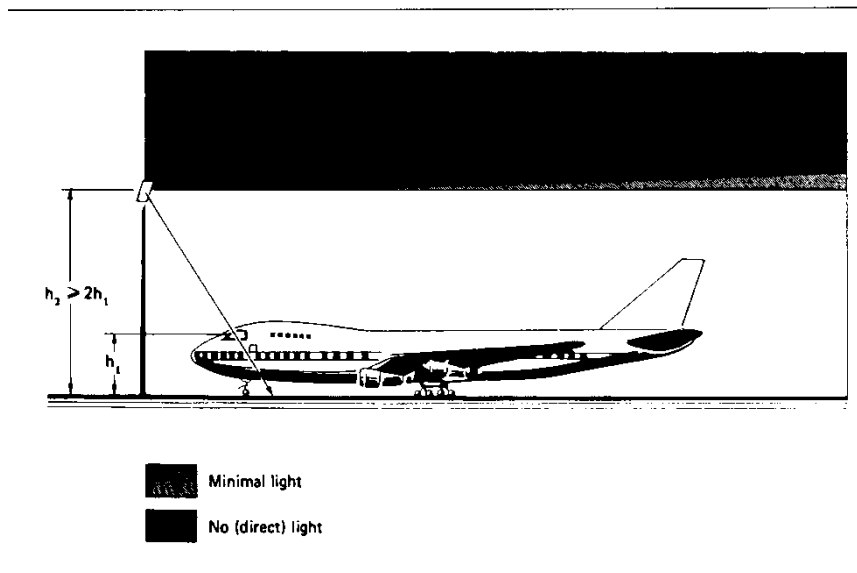
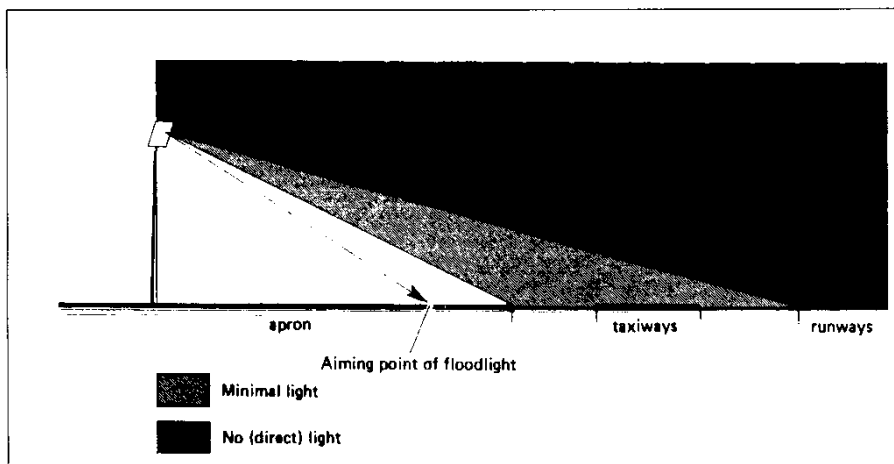

Figure 5-27. Aiming to avoid glare

— Visual docking guidance system

The rule requirements for visual docking guidance systems are contained in Part 139, Appendix E.3.20.

Application

5.3.201 A visual docking guidance system must be provided when it is intended to indicate, by a visual aid, the precise positioning of an aircraft on an aircraft stand.

Characteristics

5.3.202 The system should provide both azimuth and stopping guidance.

5.3.203 The azimuth guidance unit and the stopping position indicator should be adequate for use in all weather, visibility and pavement conditions for which the system is intended both by day and night, but should not dazzle the pilot.

5.3.204 The design should be such that:

- (a) a clear indication of failure is available to the pilot if either or both fail to give the required information
- (b) they can be turned off when the aircraft stand is not to be used.

5.3.205 The azimuth guidance unit and the stopping position indicator should be located in such a way that there is continuity of guidance between the aircraft stand markings and, the aircraft stand manoeuvring guidance lights, if present, and the visual guidance docking system.

5.3.206 The accuracy of the system should be adequate for the type of loading bridge and fixed aircraft servicing installations with which it is to be used.

5.3.207 The system should preferably be useable for all types of aircraft for which the stand is intended.

5.3.208 If selective operation is required to prepare the system for use by a particular type of aircraft, then the system should provide an identification of the selected aircraft type to both the pilot and the system operator as a means of ensuring the system has been set properly.

— Azimuth guidance unit**Location**

5.3.209 The azimuth guidance unit should be located on the extension of the stand centre line ahead of the aircraft so that its signals are visible from the cockpit of an aircraft throughout the docking manoeuvre and aligned for use by the pilot occupying the left seat.

Characteristics

5.3.210 The azimuth guidance unit should provide self-evident left and right guidance which enables the pilot to acquire and maintain the lead in line without over controlling.

5.3.211 When azimuth guidance is indicated by colour change, green should be used to identify the centre line and red for deviations from the centre line.

— Stopping position indicator**Location**

5.3.212 The stopping position indicator should be located in conjunction with, or sufficiently close to the azimuth guidance unit so that the pilot can observe both the azimuth and the stop signals without turning his head. It should preferably be useable by pilots occupying both the left and right seats, but should in any case be useable by the pilot occupying the left seat.

Characteristics

5.3.213 The stopping position information provided by the indicator for a particular aircraft type should not be significantly affected by possible variations in pilot eye height and/or viewing angle.

5.3.214 The indicator should show the stopping position for the aircraft for which guidance is being provided, and should provide closing rate information to enable the pilot to gradually decelerate the aircraft to a full stop at the intended stopping position.

5.3.215 When stopping guidance is indicated by colour change, green should be used to show that the aircraft can proceed and red to show that the stop point has been reached.

— Aircraft stand manoeuvring guidance lights**Application**

5.3.216 Aircraft stand manoeuvring guidance lights should be provided to facilitate the positioning of an aircraft on an aircraft stand intended for use in poor visibility conditions, unless adequate guidance is provided by other means.

Location

5.3.217 The lights should be collocated with the aircraft stand markings.

Characteristics

5.3.218 Aircraft stand manoeuvring guidance lights, other than those indicating a stop position, should be fixed yellow lights, visible throughout the segments within which they are intended to provide guidance.

5.3.219 Lights used to delineate lead-in, turning and lead-out lines should be spaced at intervals of not more than 7.5 m on curves and 15 m on straight sections.

5.3.220 Lights used to indicate a stop position should be fixed, unidirectional lights, showing red.

5.3.221 The intensity of the lights should be adequate for the conditions of visibility and ambient light in which the use of the aircraft stand is intended.

5.3.222 The lighting circuit should be designed so that the lights may be switched on to indicate that an aircraft stand is to be used and switched off to indicate that it is not to be used.

— Operational lighting controls**Manual control**

5.3.223 The manual control mechanism for the aerodrome lighting should be secured to prevent access by unauthorised persons.

VHF control

5.3.224 A pilot activated lighting (PAL) VHF radio switching mechanism should comply with the following.

- (a) **PAL availability** — The PAL activated aerodrome lights switching should be arranged so that the system is always automatically available at night and not dependent upon air traffic services for a switch pre-selection.
- (b) **Keying** — The switch should operate on receipt of 5 rapid and short transmissions which collectively should not exceed 3 seconds from the first to the last transmission.

- (c) **Brightness** — The lights may have a short warm up period, but following this they should switch automatically to full brilliance.

Three levels of brilliancy should be available. The control mechanism should be capable of, or have the provision for, the pilot to be able to vary the lighting intensity at any time by a further 4 similar short transmissions and a prolonged 5th one.

The lighting should continuously cycle through the intensities as long as the 5th transmission continues until the transmit button is released.

- (d) **Lights to be activated:**

- (i) runway, taxiway and tarmac edge lighting where it exists
- (ii) approach lights
- (iii) approach slope indicators
- (iv) lit wind direction indicators
- (v) the aerodrome beacon.

- (e) **Selection of lighting**—the selection of those lights applicable to a particular runway should be part of the cycling pattern referred to. It will be so arranged that the cycling will:

- (i) turn on all lighting for a runway
- (ii) cycle its brilliance (having 2.0 second dwells)
- (iii) change to the facilities for the reciprocal runway end
- (iv) cycle its brilliance
- (v) change to the next runway and repeat the procedure before reverting to the first runway and re-commencing the whole cycle again, until the transmission ceases.

Where the switching is such that the full lighting facilities are turned on for a runway, regardless of direction of use, then the cycling will only apply to brilliance control.

- (f) **Duration of lighting**—the lights should remain on for 20 minutes. During this period any single transmission should reset the timer for a further 20 minutes.

5.3.225 Failure of software or electronic control—in the event of a failure of the software or electronic switching, the lights should remain lit on the last selection made, until manual control is established.

5.3.226 For future economy and convenience it is desirable if the software for the electronic control is able to be rewritten to accommodate a changed programme as lighting facilities are changed or added to.

— **Portable or temporary runway, taxiway or apron edge lighting**

5.3.227 The lighting of runways, taxiways or apron edges with portable fittings is permissible provided the appropriate standards are met in relation to—

- (a) the physical dimensions and obstacle free gradients for the night use of the runway
- (b) the layout, spacing and colour of lights.

— **Road-holding position light**

The rule requirements for road-holding position light are contained in Part 139, Appendix E.3.21.

Application

5.3.228 In addition to the rule requirements, a road-holding position light should be provided at each road-holding position serving a runway when it is intended that the runway will be used in runway visual range conditions of values between 350 m and 550 m.

Location

5.3.229 A road-holding position light should be located adjacent to the holding position marking 1 to 2 m from the edge of the road.

Characteristics

5.3.229 The road-holding position light should be a controllable red (stop)/green (go) traffic light or a flashing-red light controlled by air traffic services.

5.3.230 The light beam should be unidirectional and aligned to be visible to the driver of a vehicle approaching the holding position. The intensity should be adequate for the conditions of visibility and ambient light in which the use of the holding position is intended, but not such that it could dazzle the driver.

5.3.231 If a flashing red light is used, the flash frequency should be between 30 and 60 flashes per minute.

5.4 Signs

The rule requirements for signs are contained in Part 139, Appendix E.4.

— **General**

Note: *Signs should be either fixed message signs or variable message signs.*

Application

5.4.1 Signs must be provided to convey a mandatory instruction, information on a specific location or destination on a movement area or to provide other information to meet the requirements of a surface movement guidance and control system.

Note: *See paragraph 5.2.109 for specifications on information marking.*

5.4.2 A variable message sign should be provided where:

- a) the instruction or information displayed on the sign is relevant only during a certain period of time: or
- b) there is a need for variable pre-determined information to be displayed on the sign, in alignment with paragraph 8.5.1.

Characteristics

- 5.4.3** Signs should be frangible. Those located near a runway or taxiway should be sufficiently low to preserve clearance for propellers and the engine pods of jet aircraft. The installed height of the sign should not exceed the dimension shown in the appropriate column of Table 5-4.
- 5.4.4** Signs should be rectangular, as shown in Figures 5-28 and 5-29 with the longer side horizontal.
- 5.4.5** The only signs on the movement area utilizing red should be mandatory instruction signs.
- 5.4.6** The inscriptions on a sign should be in accordance with the provisions of Appendix 1 of this AC.
- 5.4.7** Signs should be retroreflective and/or illuminated in accordance with the provisions of Appendix 1 of this AC when intended for use at night in association with non-instrument runways where the code number is 1 or 2.
- 5.4.8** A variable message sign should show a blank face when not in use, and in case of failure, should not provide information that could lead to unsafe action from a pilot or a vehicle driver.
- 5.4.9** The time interval to change from one message to another on a variable message sign should be as short as practicable and should not exceed 5 seconds.

Table 5-4. Location distances for taxiing guidance signs including runway exit signs

Sign height (mm)				Perpendicular distance Defined taxiway pavement edge to near side of sign	Perpendicular distance Defined runway pavement edge to near side of sign
Code number	Legend	Face (min)	Installed (max)		
1 or 2	200	400	700	5-11 m	3-10 m
1 or 2	300	600	900	5-11 m	3-10 m
3 or 4	300	600	900	11-21 m	8-15 m
3 or 4	400	800	1100	11-21 m	8-15 m

— Lighting

The rule requirements for lighting signs are contained in Part 139, Appendix E.4.2.

Application

5.4.10 Signs must be illuminated when intended for use:

- a) in runway visual range conditions less than a value of 800 m:
- b) at night in association with instrument runways:
- c) at night in association with non-instrument runways where the code number is 3 or 4.

Characteristics

5.4.11 Lighting should be in accordance with the provisions of Appendix 1 of this AC.

— Mandatory instruction signs

The rule requirements for mandatory instruction signs are contained in Part 139, Appendix E.4.3.

Note: See Figure 5-28 for pictorial representation of mandatory instruction signs and Figure 5-30 for examples of locating signs at taxiway/runway intersections.

Application

5.4.12 A mandatory instruction sign must be provided to identify a location beyond which an aircraft taxiing or vehicle should not proceed unless authorized by the aerodrome control tower.

5.4.13 Mandatory instruction signs must include runway designation signs, category I, II or III holding position signs, runway-holding position signs, road-holding position signs and NO ENTRY signs.

Note: See paragraph 5.4.78 for specifications on road-holding position signs.

5.4.14 A pattern "A" runway-holding position marking should be supplemented at a taxiway/runway intersection or a runway/runway intersection with a runway designation sign.

5.4.15 A pattern “B” runway-holding position marking should be supplemented with a category I, II or III holding position sign.

5.4.16 A pattern “A” runway-holding position marking at a runway-holding position established in accordance with paragraph 3.12.3 should be supplemented with a runway-holding position sign

Note: See paragraph 5.2.61 for characteristics on runway-holding position marking.

5.4.17 A runway designation sign at a taxiway/runway intersection should be supplemented with a location sign in the outboard (farthest from the taxiway) position, as appropriate.

Note: See paragraph 5.4.29 for characteristics of location signs.

5.4.18 A NO ENTRY sign must be provided when entry into an area is prohibited.

Location

5.4.19 A runway designation sign at a taxiway/runway intersection or a runway/runway intersection should be located on each side of the runway-holding position marking facing the direction of approach to the runway.

5.4.20 A category I, II or III holding position sign should be located on each side of the runway-holding position marking facing the direction of the approach to the critical area.

5.4.21 A NO ENTRY sign should be located at the beginning of the area to which entrance is prohibited on each side of the taxiway as viewed by the pilot.

5.4.22 A runway-holding position sign should be located on each side of the runway-holding position established in accordance with paragraph 3.12.3, facing the approach to the obstacle limitation surface or ILS/MLS critical/sensitive area, as appropriate.

Characteristics

5.4.23 A mandatory instruction sign should consist of an inscription in white on a red background.

5.4.24 The inscription on a runway designation sign should consist of the runway designations of the intersecting runway properly oriented with respect to the viewing position of the sign, except that a runway designation sign installed in the vicinity of a runway extremity may show the runway designation of the concerned runway extremity only.

5.4.25 The inscription on a category I, II, III or joint II/III holding position sign should consist of the runway designator followed by CAT I, CAT II, CAT III or CAT II/III, as appropriate.

5.4.26 The inscription on a NO ENTRY sign should be in accordance with Figure 5-28.

5.4.27 The inscription on a runway-holding position sign at a runway-holding position established in accordance with paragraph 3.11.3 should consist of the taxiway designation and a number.

5.4.28 Where appropriate, the following inscriptions/symbol should be used—

Inscription/ symbol	Use
Runway designation of a runway extremity	To indicate a runway-holding position at a runway extremity.
OR	
Runway designation of both extremities of a runway	To indicate a runway-holding position located at other taxiway/runway intersections or runway/runway intersections.
25 CAT I (Example)	To indicate a category I runway holding position at the threshold of runway 25.
25 CAT II (Example)	To indicate a category II runway holding position at the threshold of runway 25.
25 CAT III (Example)	To indicate a category III runway holding position at the threshold of runway 25.
25 CAT II/III (Example)	To indicate a joint category II/III runway-holding position at the threshold of runway 25.
NO ENTRY symbol	To indicate that entry to an area is prohibited.
B2 (Example)	To indicate a runway-holding position established in accordance with paragraph 3.12.3.

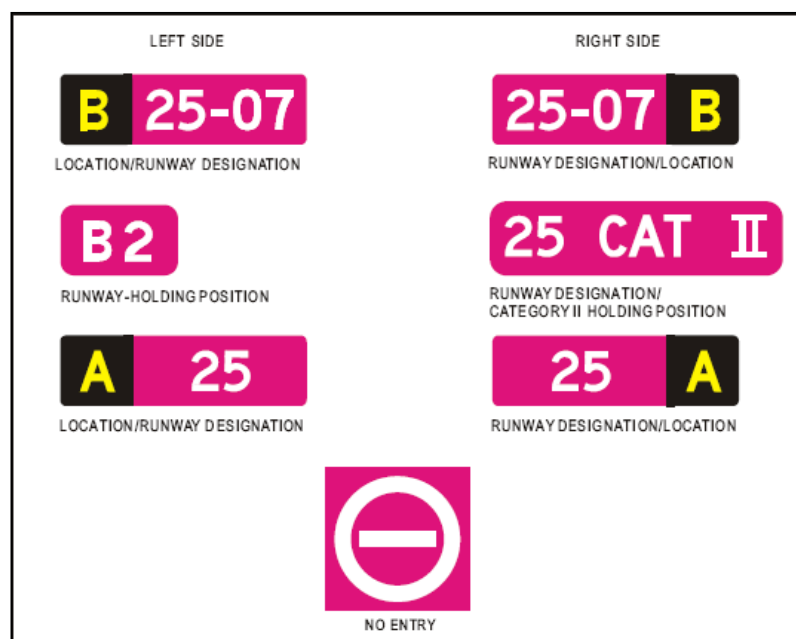

Figure 5-28 Mandatory instruction signs

— **Information signs**

The rule requirements for mandatory instruction signs are contained in Part 139, Appendix E.4.4.

Note: See Figure 5-27 for pictorial representations of information signs.

Application

5.4.29 An information sign must be provided where there is an operational need to identify by a sign, a specific location, or routing (direction or destination) information.

5.4.30 Information signs include direction signs, location signs, destination signs, runway exit signs, runway vacated signs and intersection take-off signs.

5.4.31 A runway exit sign must be provided where there is an operational need to identify a runway exit.

5.4.32 A runway vacated sign must be provided where the exit taxiway is not provided with taxiway centre line lights, and there is a need to indicate to a pilot leaving a runway the perimeter of the ILS/MLS critical/sensitive area, or the lower edge of the inner transitional surface whichever is farther from the runway centre line.

5.4.33 An intersection take-off sign should be provided when there is an operational need to indicate the remaining take-off run available (TORA) for intersection take-offs.

5.4.34 Where necessary, a destination sign should be provided to indicate the direction to a specific destination on the aerodrome, such as cargo area, general aviation, etc.

5.4.35 A combined location and direction sign must be provided when it is intended to indicate routing information prior to a taxiway intersection.

5.4.36 A direction sign must be provided when there is an operational need to identify the designation and direction of taxiways at an intersection.

5.4.37 A location sign must be provided at an intermediate holding position.

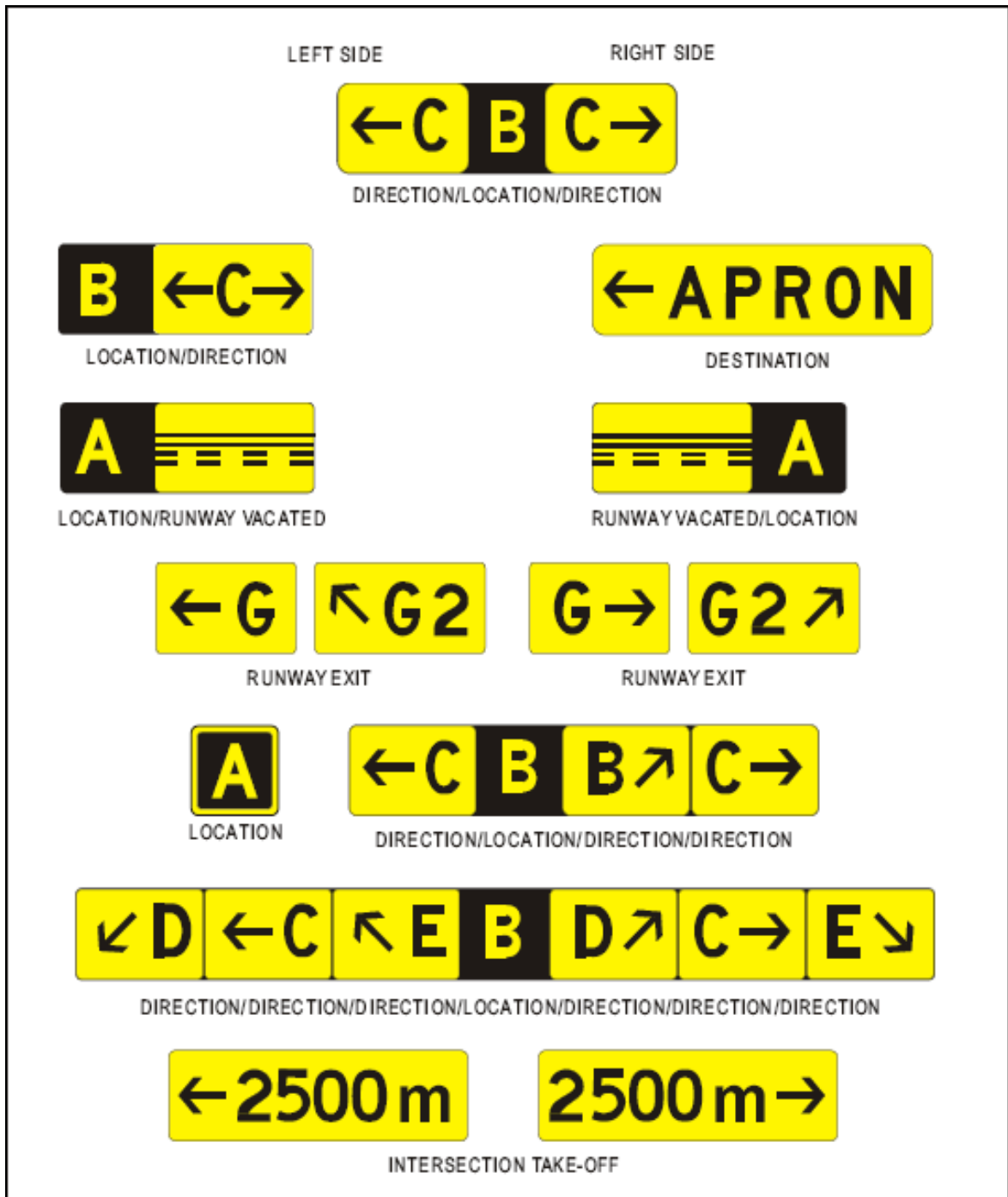
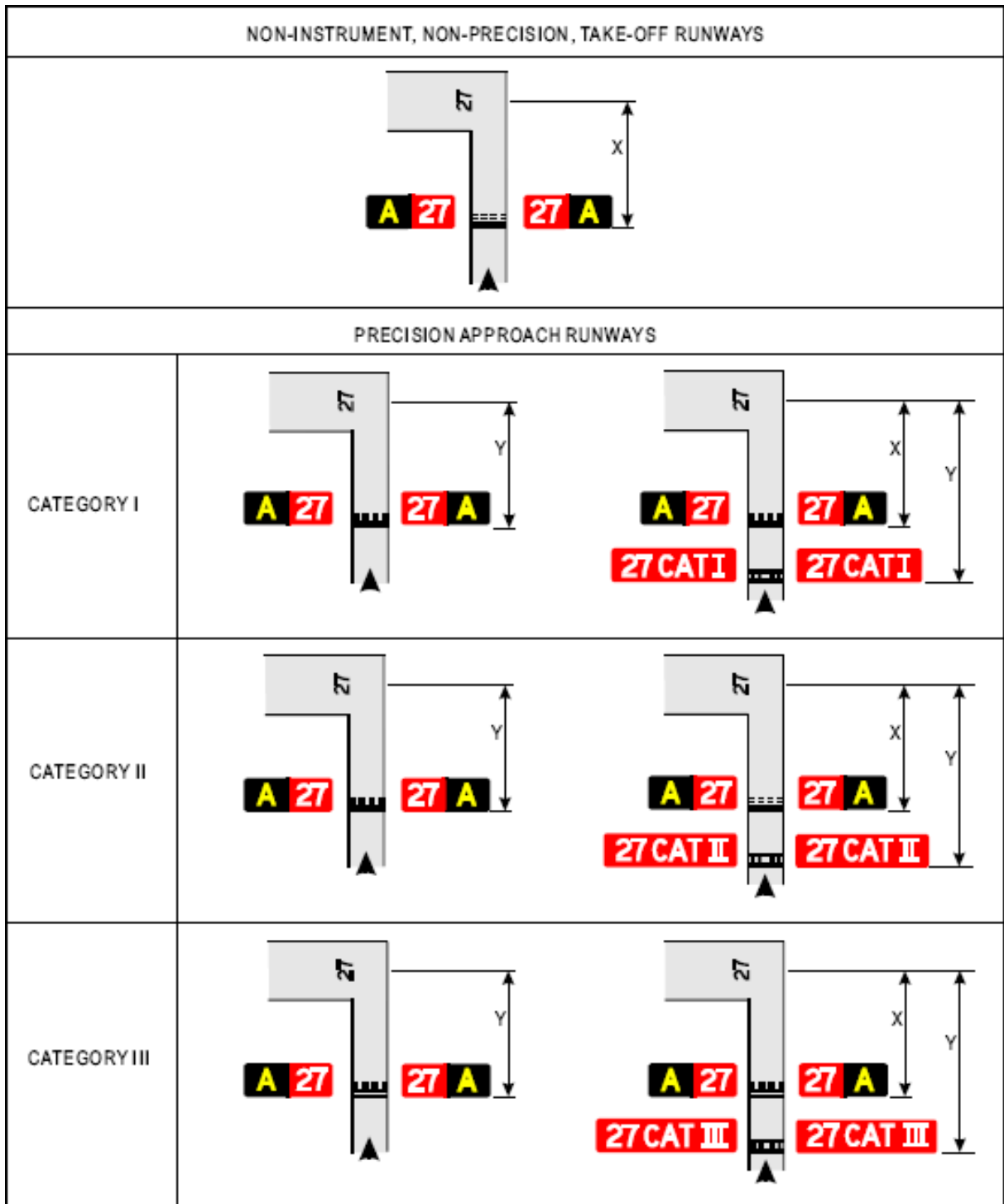

Figure 5-29 Information signs



Note: Distance *X* is established in accordance with Table 3-2. Distance *Y* is established at the edge of the ILS/MLS critical/sensitive area.

Figure 5-30 Examples of sign position at taxiway/runway intersections

5.4.38 A location sign should be provided in conjunction with a runway designation sign except at a runway/runway intersection.

5.4.39 A location sign should be provided in conjunction with a direction sign, except that it may be omitted where an aeronautical study indicates that it is not needed.

5.4.40 Where necessary, a location sign should be provided to identify taxiways exiting an apron or taxiways beyond an intersection.

5.4.41 Where a taxiway ends at an intersection such as a “T” and it is necessary to identify this, a barricade, direction sign and/or other appropriate visual aid should be used.

Location

5.4.42 Except as specified in paragraphs 5.4.44 and 5.4.52 information signs should, wherever practicable, be located on the left-hand side of the taxiway in accordance with Table 5-4.

5.4.43 At a taxiway intersection, information signs should be located prior to the intersection and in line with the taxiway intersection marking. Where there is no taxiway intersection marking, the signs should be installed at least 60 m from the centre line of the intersecting taxiway where the code number is 3 or 4 and at least 40 m where the code number is 1 or 2.

Note: A location sign installed beyond a taxiway intersection may be installed on either side of a taxiway.

5.4.44 A runway exit sign should be located on the same side of the runway as the exit is located (i.e. left or right) and positioned in accordance with Table 5-4.

5.4.45 A runway exit sign should be located prior to the runway exit point in line with a position at least 60 m prior to the point of tangency where the code number is 3 or 4, and at least 30 m where the code number is 1 or 2.

5.4.46 A runway vacated sign should be located at least on one side of the taxiway. The distance between the sign and the centre line of a runway should be not less than the greater of the following:

- a) the distance between the centre line of the runway and the perimeter of the ILS/MLS critical/sensitive area: or
- b) the distance between the centre line of the runway and the lower edge of the inner transitional surface.

5.4.47 Where provided in conjunction with a runway vacated sign, the taxiway location sign should be positioned outboard of the runway vacated sign.

5.4.48 An intersection take-off sign should be located at the left-hand side of the entry taxiway. The distance between the sign and the centre line of the runway should be not less than 60 m where the code number is 3 or 4 and not less than 45 m where the code number is 1 or 2.

5.4.49 A taxiway location sign installed in conjunction with a runway designation sign should be positioned outboard of the runway designation sign.

5.4.50 A destination sign should not normally be collocated with a location or direction sign.

5.4.51 An information sign other than a location sign should not be collocated with a mandatory instruction sign.

5.4.52 A direction sign, barricade and/or other appropriate visual aid used to identify a “T” intersection should be located on the opposite side of the intersection facing the taxiway.

Characteristics

5.4.53 An information sign other than a location sign should consist of an inscription in black on a yellow background.

5.4.54 A location sign should consist of an inscription in yellow on a black background and where it is a stand-alone sign should have a yellow border.

5.4.55 The inscription on a runway exit sign should consist of the designator of the exit taxiway and an arrow indicating the direction to follow.

5.4.56 The inscription on a runway vacated sign should depict the pattern A runway-holding position marking as shown in Figure 5-29.

5.4.57 The inscription on an intersection take-off sign should consist of a numerical message indicating the remaining take-off run available in metres plus an arrow, appropriately located and oriented, indicating the direction of the take-off as shown in Figure 5-29.

5.4.58 The inscription on a destination sign should comprise an alpha, alphanumerical or numerical message identifying the destination plus an arrow indicating the direction to proceed as shown in Figure 5-29.

5.4.59 The inscription on a direction sign should comprise an alpha or alphanumerical message identifying the taxiway(s) plus an arrow or arrows appropriately oriented as shown in Figure 5-29.

5.4.60 The inscription on a location sign should comprise the designation of the location taxiway, runway or other pavement the aircraft is on or is entering and should not contain arrows.

5.4.61 Where it is necessary to identify each of a series of intermediate holding positions on the same taxiway, the location sign should consist of the taxiway designation and a number.

5.4.62 Where a location sign and direction signs are used in combination:

- a) all direction signs related to left turns should be placed on the left side of the location sign and all direction signs related to right turns should be placed on the right side of the location sign, except that where the junction consists of one intersecting taxiway, the location sign may alternatively be placed on the left hand side
- b) the direction signs should be placed such that the direction of the arrows departs increasingly from the vertical with increasing deviation of the corresponding taxiway
- c) an appropriate direction sign should be placed next to the location sign where the direction of the location taxiway changes significantly beyond the intersection
- d) adjacent direction signs should be delineated by a vertical black line as shown in Figure 5-29.

5.4.63 A taxiway should be identified by a designator comprising a letter, letters or a combination of a letter or letters followed by a number.

5.4.64 When designating taxiways, the use of the letters I, O or X and the use of words such as inner and outer should be avoided wherever possible to avoid confusion with the numerals 1, 0 and closed marking.

5.4.65 The use of numbers alone on the manoeuvring area should be reserved for the designation of runways.

— **VOR aerodrome check-point sign**

The rule requirements for VOR aerodrome check-point signs are contained in Part 139, Appendix E.4.5.

Application

5.4.66 When a VOR aerodrome check-point is established, it must be indicated by a VOR aerodrome check-point marking and sign.

Note: See 5.2.70 for VOR aerodrome check-point marking.

Location

5.4.67 A VOR aerodrome check-point sign should be located as near as possible to the check-point and so that the inscriptions are visible from the cockpit of an aircraft properly positioned on the VOR aerodrome check-point marking.

Characteristics

5.4.68 A VOR aerodrome check-point sign should consist of an inscription in black on a yellow background.

5.4.69 The inscriptions on a VOR check-point sign should be in accordance with one of the alternatives shown in Figure 5-31 in which—

VOR	is an abbreviation identifying this as a VOR check-point
116.3	is an example of the radio frequency of the VOR concerned
147°	is an example of the VOR bearing, to the nearest degree, which should be indicated at the VOR check-point
4.3 NM	is an example of the distance in nautical miles to a DME collocated with the VOR concerned.

Note: *Tolerances for the bearing value shown on the sign are given in Annex 10, Volume I, Attachment E to Part I. It will be noted that a check-point can only be used operationally when periodic checks show it to be consistently within ± 2 degrees of the stated bearing.*

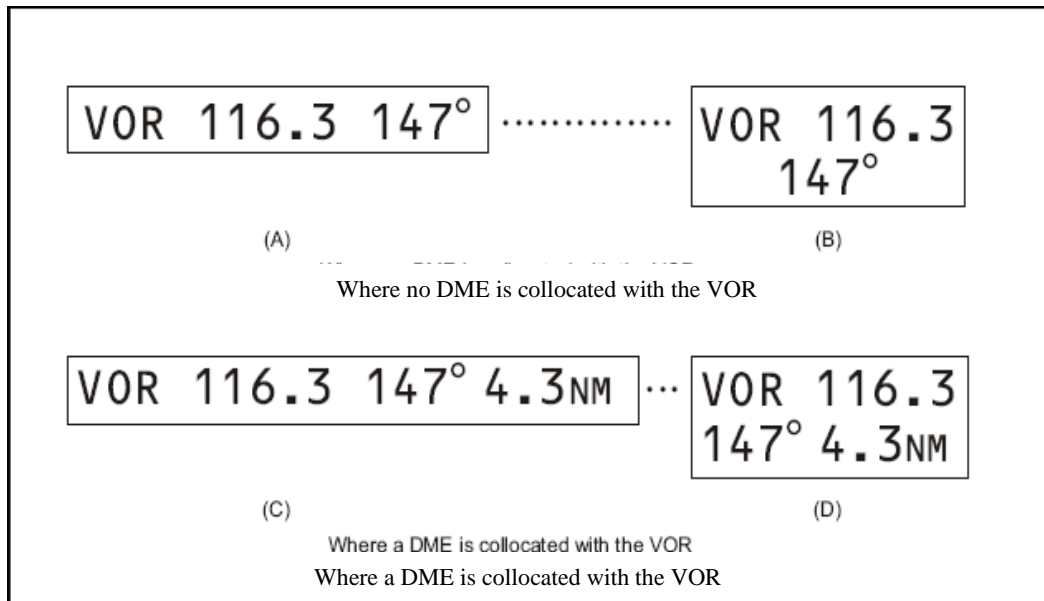

Figure 5-31. VOR aerodrome check point sign

— **Aerodrome identification sign**

Application

5.4.70 An aerodrome identification sign should be provided at an aerodrome where there is insufficient alternative means of visual identification.

Location

5.4.71 The aerodrome identification sign should be placed on the aerodrome so as to be legible, in so far as is practicable, at all angles above the horizontal.

Characteristics

5.4.72 The aerodrome identification sign should consist of the name of the aerodrome.

5.4.73 The colour selected for the sign should give adequate conspicuity when viewed against its background.

5.4.74 The characters should have a height of not less than 3 m.

— **Aircraft stand identification signs**

Application

5.4.75 An aircraft stand identification marking should be supplemented with an aircraft stand identification sign where feasible.

Location

5.4.76 An aircraft stand identification sign should be located so as to be clearly visible from the cockpit of an aircraft prior to entering the aircraft stand.

Characteristics

5.4.77 An aircraft stand identification sign should consist of an inscription in black on a yellow background.

— **Road-holding position sign**

The rule requirements for road-holding position signs are contained in Part 139, Appendix E.4.6.

5.4.78 A road-holding position sign must be provided at all road entrances to a runway.

Location

5.4.79 The road-holding position sign should be located 1.5 m from one edge of the road (left or right as appropriate to the local traffic regulations) at the holding position.

Characteristics

5.4.80 A road-holding position sign should consist of an inscription in white on a red background.

5.4.81 The inscription on a road-holding position sign should be in English, be in conformity with the local traffic regulations and include the following—

- (a) a requirement to stop
- (b) where appropriate:
 - (i) a requirement to obtain ATC clearance
 - (ii) location designator.

5.4.82 A road-holding position sign intended for night use should be retroreflective or illuminated.

5.5 Markers

The rule requirements for markers signs are contained in Part 139, Appendix E.4.7.

— **General**

5.5.1 Markers must be light-weight and frangible mounted. Those located near a runway or taxiway must be sufficiently low to preserve clearance for propellers and for the engine pods of jet aircraft.

— **Unpaved runway edge markers**

Application

5.5.2 Markers should be provided when the extent of an unpaved runway is not clearly indicated by the appearance of its surface compared with that of the surrounding ground.

Location

5.5.3 Where runway lights are provided, the markers should be incorporated in the light fixtures. Where there are no lights, markers of flat rectangular or conical shape should be placed so as to delimit the runway clearly.

Characteristics

5.5.4 The flat rectangular markers should have a minimum size of 1 m by 3 m and should be placed with their long dimension parallel to the runway centre line. The conical markers should have a height not exceeding 0.5 m.

— **Stopway edge markers**

Application

5.5.5 Stopway edge markers should be provided when the extent of a stopway is not clearly indicated by its appearance compared with that of the surrounding ground.

Characteristics

5.5.6 The stopway edge markers should be sufficiently different from any runway edge markers used to ensure that the two types of markers cannot be confused.

— **Edge markers for snow covered runways**

Application

5.5.7 Edge markers for snow covered runways should be used to indicate the useable limits of a snow covered runway when the limits are not otherwise indicated.

Note: Runway lights could be used to indicate the limits.

Location

5.5.8 Edge markers for snow covered runways should be placed along the sides of the runway at intervals of not more than 100 m, and should be located symmetrically about the runway centre line at such a distance from the centre line that there is adequate clearance for wing tips and power plants. Sufficient markers should be placed across the threshold and end of the runway.

Characteristics

5.5.9 Edge markers for snow covered runways should consist of light weight conspicuous frangible markers at a height not exceeding 0.5 m above snow level.

— **Taxiway edge markers**

Application

5.5.10 Taxiway edge markers should be provided on a taxiway where the code number is 1 or 2 and taxiway centre line or edge lights or taxiway centre line markers are not provided.

Location

5.5.11 Taxiway edge markers should be installed at least the same location as would the taxiway edge lights had they been used.

Characteristics

5.5.12 A taxiway edge marker should be retroreflective.

5.5.13 The marked surface as viewed by the pilot should be rectangular and should have a minimum viewing area of 150 cm².

5.5.14 Taxiway edge markers should be light weight and frangible. Their height should be sufficiently low to preserve clearance for propellers and engine pods of jet aircraft.

— **Taxiway centre line markers**

Application

5.5.15 Taxiway centre line markers should be provided on a taxiway where the code number is 1 or 2 and taxiway centre line or edge lights or edge markers are not provided.

5.5.16 Taxiway centre line markers should be provided on a taxiway where the code number is 3 or 4 and taxiway centre line lights are not provided if there is a need to improve the guidance provided by the taxiway centre line marking.

Location

5.5.17 Taxiway centre line markers should be installed at least at the same location as would taxiway centre line lights had they been used.

5.5.18 Taxiway centre line markers should normally be located on the taxiway centre line marking except they may be offset by not more than 0.3 m where it is not practicable to locate them on the marking.

Characteristics

5.5.19 A taxiway centre line marker should be retroreflective green.

5.5.20 The marked surface as viewed by the pilot should be a rectangle and have a minimum viewing area of 2 m².

5.5.21 Taxiway centre line markers should be so designed and fitted as to withstand being run over by the wheels of an aircraft without damage either to the aircraft or to the markers themselves.

— Unpaved taxiway edge markers

Application

5.5.22 Where the extent of an unpaved taxiway is not clearly indicated by its appearance compared with that of the surrounding ground, markers should be provided.

Location

5.5.23 Where taxiway lights are provided, the markers should be incorporated in the light fixtures. Where there are no lights, markers of conical shape should be placed so as to delimit the taxiway clearly.

— Boundary marking

Application

5.5.24 Boundary marking should be provided at an aerodrome where the landing area has no defined runway.

Location

5.5.25 Boundary markers should be spaced along the boundary of the landing area at intervals of not more than 200 m, if the type shown in Figure 5-32 is used, or approximately 90 m, if the conical type is used with a marker at any corner.

Characteristics

5.5.26 Boundary markers should be of a form similar to that shown in Figure 5-32, or in the form of a cone not more than 0.5 m high and not more than 0.75 m in diameter at the base. The markers should be coloured to contrast with the background against which they will be seen. A single colour, orange or red, or two contrasting colours, orange and white or alternatively red and white, should be used, except where such colours merge with the background. A marker board can be free standing (non-secured) if it has been suitably tested to withstand wind speeds of over

100km/hour

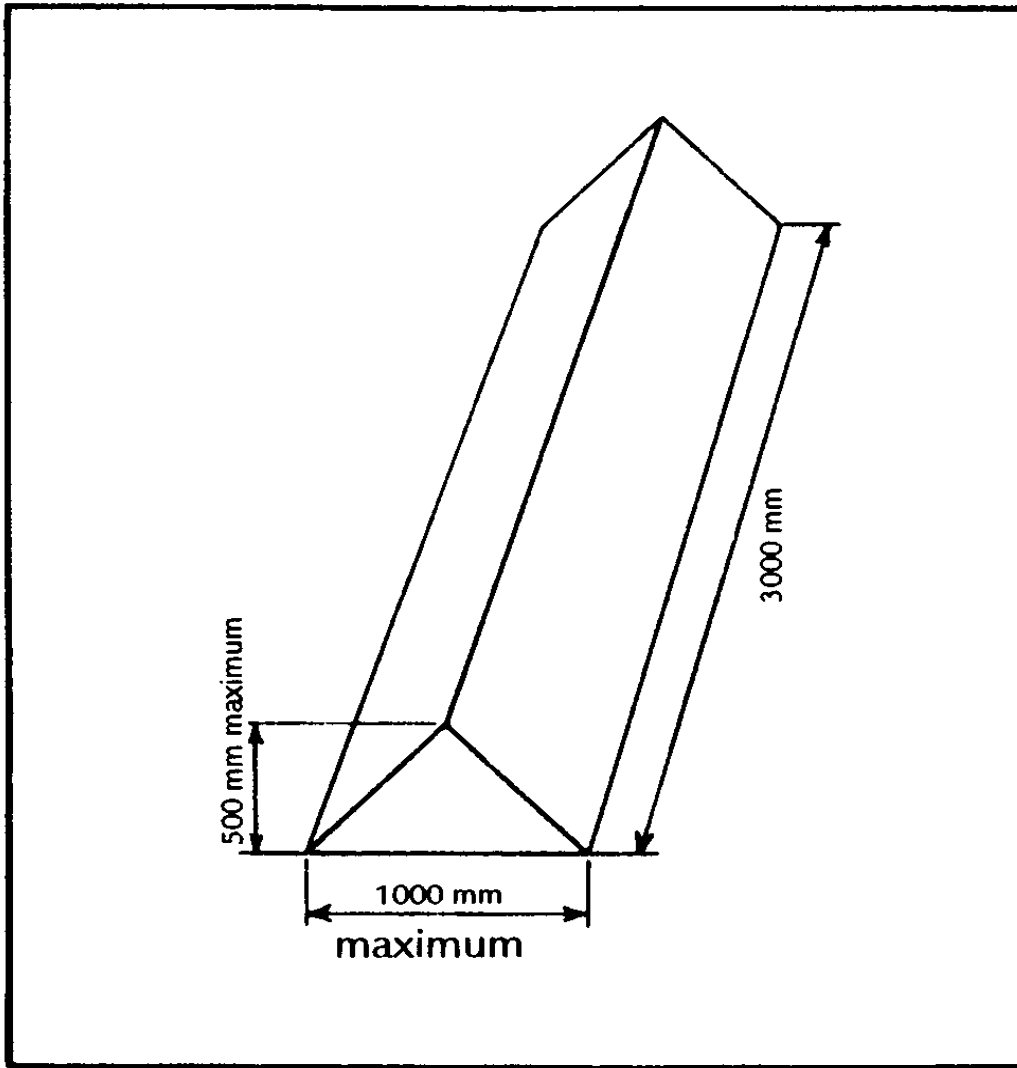

Figure 5-32 Marker Board

6. VISUAL AIDS FOR DENOTING OBSTACLES

6.1 Objects to be marked or lighted

The rule requirements for objects to be marked or lighted are contained in Part 139, Appendix F.1.

6.1.1 A fixed obstacle that extends above a take-off climb, approach, or transitional surface within 3000 m of the inner edge must be marked and, if the runway is used at night, lighted, except that:

- (a) such marking and lighting may be omitted when the obstacle is shielded by another fixed obstacle already marked or lit:
- (b) the marking may be omitted when the obstacle is lighted by medium-intensity obstacle lights, Type A, by day and its height above the level of the surrounding ground does not exceed 150 m:
- (c) the marking may be omitted when the obstacle is lighted by high-intensity obstacle lights by day:
- (d) the lighting may be omitted where the obstacle is a lighthouse and an aeronautical study indicates the lighthouse light to be sufficient.

6.1.2 A fixed object, other than an obstacle, adjacent to a take-off climb surface should be marked and, if the runway is used at night, lighted if such marking and lighting is considered necessary to ensure its avoidance, except that the marking may be omitted when:

- (a) the object is lighted by medium-intensity obstacle lights, Type A, by day and its height above the level of the surrounding ground does not exceed 150 m:
- (b) the object is lighted by high-intensity obstacle lights by day.

6.1.3 A fixed obstacle above a horizontal surface should be marked and, if the aerodrome is used at night, lighted except that:

- (a) such marking and lighting may be omitted when:
 - (i) the obstacle is shielded by another fixed obstacle:
 - (ii) for a circuit extensively obstructed by immovable objects or terrain, procedures have been established to ensure safe vertical clearance below prescribed flight paths:
 - (iii) an aeronautical study shows the obstacle not to be of operational significance
- (b) the object is lighted by medium-intensity obstacle lights, Type A, by day and its height above the level of the surrounding ground does not exceed 150 m
- (c) the lighting may be omitted where the obstacle is a lighthouse and an aeronautical study indicates the lighthouse light to be sufficient.

6.1.4. A fixed object that extends above an obstacle protection surface must be marked and, if the runway is used at night, lighted.

6.1.5 Vehicles and other mobile objects, excluding aircraft, on the movement area of an aerodrome are obstacles and must be marked and, if the vehicles and aerodrome are used at

night or in conditions of low visibility, lighted, except that aircraft servicing equipment and vehicles used only on aprons need not be marked or lighted.

6.1.6 Elevated aeronautical ground lights within the movement area must be marked so as to be conspicuous by day. Obstacle lights should not be installed on elevated ground lights or signs in the movement area.

6.1.7 All obstacles within the distance specified in Part 139 Appendix F, Table F-1, from the centre line of a taxiway, an apron taxiway, or aircraft stand taxiway must be marked and, if the taxiway, apron taxiway, or aircraft stand taxiway is used at night, lighted.

6.1.8 Obstacles in accordance with paragraph 4.3.2 should be marked and lighted, except that the marking may be omitted when the obstacle is lighted by high-intensity obstacle lights by day.

6.1.9 Overhead wires, cables, etc., crossing a river, valley or highway should be marked and their supporting towers marked and lighted if an aeronautical study indicates that the wires or cables could constitute a hazard to aircraft, except that the marking of the supporting towers may be omitted when they are lighted by high-intensity obstacle lights by day.

6.1.10 When it has been determined that an overhead wire, cable, etc., needs to be marked but it is not practicable to install markers on the wire, cable, etc., then high-intensity obstacle lights, Type B, should be provided on their supporting towers.

6.2 Marking of objects

The rule requirements for marking of objects are contained in Part 139, Appendix F.2.

— General

6.2.1 All fixed objects to be marked must, whenever practicable, be coloured, but if this is not practicable, markers or flags must be displayed on or above them, except that the objects that are sufficiently conspicuous by their shape, size or colour need not be otherwise marked.

6.2.2 All mobile objects to be marked must be coloured or display flags.

— Use of colours

6.2.3 An object should be coloured to show a chequered pattern if it has essentially unbroken surfaces and its projection on any vertical plane equals or exceeds 4.5 m in both dimensions. The pattern should consist of rectangles of not less than 1.5 m and not more than 3 m on a side, the corners being of the darker colour. The colours of the pattern should contrast each with the other and with the background against which they will be seen. Orange and white or alternatively red and white should be used, except where such colours merge with the background. See Figure 6-1.

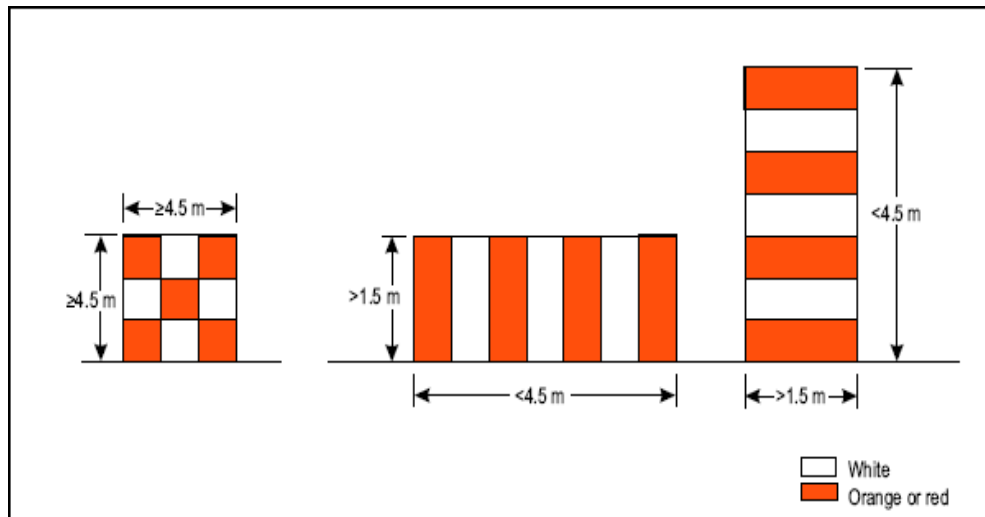

Figure 6-1. Basic marking patterns

6.2.4 An object should be coloured to show alternating contrasting bands if:

- (a) it has essentially unbroken surfaces, and has one dimension, horizontal or vertical, greater than 1.5 m, and the other dimension, horizontal or vertical, less than 4.5 m:
- (b) it is of skeletal type with either a vertical or a horizontal dimension greater than 1.5 m.

6.2.5 The bands should be perpendicular to the longest dimension and have a width approximately one seventh of the longest dimension or 30m, whichever is less. The colours of the bands should contrast with the background against which they will be seen. Orange and white should be used, except where such colours are not conspicuous when viewed against the background. The bands on the extremities of the object should be of the darker colour.

6.2.6 The following table shows a formula for determining band widths and for having an odd number of bands, thus permitting both the top and bottom bands to be of the darker colour.

Longest dimension		Band width
Greater than	Not exceeding	
1.5 m	210 m	1/7 of longest dimension
210 m	270 m	1/9 " " "
270 m	330 m	1/11 " " "
330 m	390 m	1/13 " " "
390 m	450 m	1/15 " " "
450 m	510 m	1/17 " " "
510 m	570 m	1/19 " " "
570 m	630 m	1/21 " " "

6.2.7 An object should be coloured in a single conspicuous colour if its projection on any vertical plane has both dimensions less than 1.5 m. Orange or red should be used except where such colours merge with the background.

6.2.8 Mobile objects regularly on the movement areas should be marked in colours to enhance contrast with the background environment and optimise day and night time visibility and identification. They should be marked in a single conspicuous colour, preferably red or yellowish green for emergency vehicles and yellow for service vehicles.

6.2.9 Other vehicles which are required to move about the manoeuvring area on occasion should display by day a red/white or orange/white chequered flag approximately one metre square on a pole some 2 m high, or display flashing amber or red lights.

6.2.10 It is acceptable to use un-marked vehicles for brief specific excursions onto the manoeuvring area provided that two-way radio control is exercised by the ATS unit.

6.2.11 All vehicles on the manoeuvring areas at night should display a flashing light, amber for service vehicles and red for emergency vehicles.

— **Use of markers**

The rule requirements for the use of markers are contained in Part 139, Appendix F.3.

6.2.12 Markers displayed on or adjacent to objects must be located in a conspicuous position so as to retain the general definition of the object. They must be recognisable in clear weather from a distance of at least 1000 m for an object to be viewed from the air and 300 m for an object to be viewed from the ground in all directions in which an aircraft is likely to approach the object. The shape of the markers must be distinctive to the extent necessary to ensure they are not mistaken for markers employed to convey other information, and they must be such that the hazard presented by the object they mark is not increased.

6.2.13 A marker displayed on an overhead wire, cable, etc., should be spherical and have a diameter of not less than 600mm.

6.2.14 The spacing between two consecutive markers or between a marker and a supporting tower should be appropriate to the diameter of the marker, but in no case should the distance exceed:

- (a) 30 m where the marker diameter is 0.6 m progressively increasing with the diameter of the marker to:
- (b) 35 m where the marker diameter is 0.8 m and further progressively increasing to a maximum of:
- (c) 40 m where the marker diameter is of at least 1.3 m.

6.2.15 Where multiple wires, cables, or similar are involved, a marker should be located not lower than the level of the highest wire at the point marked.

6.2.16 A marker should be of one colour. When installed, white and red, or white and orange markers should be displayed alternately. The colour selected should contrast with the background against which it will be seen.

— **Use of flags**

The rule requirements for the use of flags are contained in Part 139, Appendix F.4.

6.2.17 Flags used to mark objects must be displayed around, on top of, or around the highest edge of, the object. When flags are used to mark extensive objects or groups of closely spaced objects, they must be displayed at least every 15 m. Flags must not increase the hazard presented by the object they mark.

6.2.18 Flags used to mark fixed objects must not be less than 0.6 m by 0.6 m and flags used to mark mobile objects, not less than 0.9 m by 0.9 m.

6.2.19 Flags used to mark fixed objects should be orange in colour or a combination of two triangular sections, one orange and the other white, or one red and the other white, except that where such colours merge with the background, other conspicuous colours should be used.

6.2.20 Flags used to mark mobile objects must consist of a chequered pattern, each square having sides of not less than 0.3 m. The colours of the pattern must contrast each with the other and with the background against which they will be seen. Orange and white or alternatively red and white should be used, except where such colours merge with the background.

6.3 Lighting of objects

The rule requirements for the lighting of objects are contained in Part 139, Appendix F.5.

— Use of obstacle lights

6.3.1 The purpose of lighting an obstacle is to warn pilots of its presence during the hours of darkness and during periods of poor daytime visibility. This should be done in such a manner that it will attract the attention of the pilot of any aircraft that is approaching the obstacle from any angle while at any altitude up to 450 m (1500 ft) above the highest point on the obstruction.

6.3.2 Obstacles that are deemed to be shielded by others need not be lit as they benefit from the lighting of the object that shields them. However, where a shielded object is only a little lower than the prime one, and some distance removed but virtually abeam or a little rearwards of it, it may require lighting.

6.3.3 The presence of objects which must be lighted must be indicated by low-, medium- or high-intensity obstacle lights, or a combination of such lights. High-intensity obstacle lights are intended for day use as well as night use. Care is needed to ensure that these lights do not create disconcerting dazzle.

The characteristics of obstacle lights are detailed in Table 6-2.

6.3.4 Low-intensity obstacle lights, Type A or B, should be used where the object is a less extensive one and its height above the surrounding ground is less than 45 m.

6.3.5 Where the use of low-intensity obstacle lights, Type A or B, would be inadequate or an early special warning is required, then medium- or high-intensity obstacle lights should be used.

6.3.6 Low-intensity obstacle lights, Type C, must be displayed on vehicles and other mobile objects excluding aircraft.

6.3.7 Low-intensity obstacle lights, Type D, must be displayed on follow-me vehicles.

6.3.8 Low-intensity obstacle lights, Type B, should be used either alone or in combination with medium-intensity obstacle lights, Type B, in accordance with paragraph 6.3.9.

6.3.9 Medium-intensity obstacle lights, Type A, B or C, should be used where the object is an extensive one or its height is greater than 45 m. Medium-intensity obstacle lights, Type A and C,

should be used alone, whereas medium intensity lights, Type B, should be either alone or in combination with low-intensity obstacle lights, Type B.

A group of trees or buildings is regarded as an extensive object.

6.3.10 High-intensity obstacle lights, Type A, should be used to indicate the presence of an object if its height above the level of the surrounding ground exceeds 150 m and an aeronautical study indicates such lights to be essential for the recognition of the object by day.

6.3.11 High-intensity obstacle lights, Type B, should be used to indicate the presence of a tower supporting overhead wires, cables, etc., where:

- (a) an aeronautical study indicates such lights to be essential for the recognition of the presence of wires, cables, etc.:
- (b) it has not been found practicable to install markers on the wires, cables, etc.

6.3.12 Where, in the opinion of the appropriate authority, the use of high-intensity obstacle lights, Type A or B, or medium-intensity obstacle lights, Type A, at night may dazzle pilots in the vicinity of an aerodrome (within approximately 10,000 m radius) or cause significant environmental concerns, a dual obstacle lighting system should be provided. This system should be composed of high-intensity obstacle lights, Type A or B, or medium intensity obstacle lights, Type A, as appropriate, for daytime and twilight use and medium-intensity obstacle lights, Type B or C, for night-time use.

— **Location of obstacle lights**

6.3.13 One or more low-, medium- or high-intensity obstacle lights should be located as close as practicable to the top of the object. The top lights should be so arranged as to at least indicate the points or edges of the object highest in relation to the obstacle limitation surface.

6.3.14 In the case of chimney or other structure of like function, the top lights should be placed sufficiently below the top so as to minimize contamination by smoke etc. (see Figures 6-2 and 6-3).

6.3.15 In the case of a tower or antenna structure indicated by high-intensity obstacle lights by day with an appurtenance, such as a rod or an antenna, greater than 12 m where it is not practicable to locate a high-intensity obstacle light on the top of the appurtenance, such a light should be located at the highest practicable point and, if practicable, a medium-intensity obstacle light, Type A, mounted on the top.

6.3.16 In the case of an extensive object or of a group of closely spaced objects, top lights should be displayed at least on the points or edges of the objects highest in relation to the obstacle limitation surface, so as to indicate the general definition and the extent of the objects. If two or more edges are of the same height, the edge nearest the landing area should be marked. Where low-intensity lights are used, they should be spaced at longitudinal intervals not exceeding 45 m. Where medium-intensity lights are used, they should be spaced at longitudinal intervals not exceeding 900 m.

6.3.17 When the obstacle limitation surface concerned is sloping and the highest point above the obstacle limitation surface is not the highest point of the object, additional obstacle lights should be placed on the highest point of the object.

6.3.18 Where an object is indicated by medium-intensity obstacle lights, Type A, and the top of the object is more than 105 m above the level of the surrounding ground or the elevation of tops

of nearby buildings (when the object to be marked is surrounded by buildings), additional lights should be provided at intermediate levels. These additional intermediate lights should be spaced as equally as practicable, between the top lights and ground level or the level of tops of nearby buildings, as appropriate, with the spacing not exceeding 105m (see paragraph 6.3.9).

6.3.19 Where an object is indicated by medium-intensity obstacle lights, Type B, and the top of the object is more than 45 m above the level of the surrounding ground or the elevation of tops of nearby buildings (when the object to be marked is surrounded by buildings), additional lights should be provided at intermediate levels. These additional intermediate lights should be alternately low-intensity obstacle lights, Type B, and medium-intensity obstacle lights, Type B, and should be spaced as equally as practicable between the top lights and ground level or the level of tops of nearby buildings, as appropriate, with the spacing not exceeding 52 m.

6.3.20 Where an object is indicated by medium-intensity obstacle lights, Type C, and the top of the object is more than 45 m above the level of the surrounding ground or the elevation of tops of nearby buildings (when the object to be marked is surrounded by buildings), additional lights should be provided at intermediate levels. These additional intermediate lights should be spaced as equally as practicable, between the top lights and ground level or the level of tops of nearby buildings, as appropriate, with the spacing not exceeding 52 m.

6.3.21 Where high-intensity obstacle lights, Type A, are used, they should be spaced at uniform intervals not exceeding 105 m between the ground level and the top light(s) specified in paragraph 6.3.13 except that where an object to be marked is surrounded by buildings, the elevation of the tops of the buildings may be used as the equivalent of the ground level when determining the number of light levels.

6.3.22 Where high-intensity obstacle lights, Type B, are used, they should be located at three levels:

- (1) at the top of the tower:
- (2) at the lowest level of the catenary of the wires or cables:
- (3) at approximately midway between these two levels.

Note: *In some cases, this may require locating the lights off the tower.*

6.3.23 The installation setting angles for high-intensity obstacle lights, Types A and B, should be in accordance with Table 6-1.

Table 6-1 Installation setting angles for high-intensity obstacle lights.

Height of light unit above terrain	Angle of the peak of the beam above the horizontal
Greater than 151 m AGL	0°
122 m to 151 m AGL	1°
92 m to 122 m AGL	2°
Less than 92 m AGL	3°

6.3.24 The number and arrangement of lights at each level to be marked should be such that the object is marked from every angle in azimuth. Where a light is shielded in any direction by an adjacent object, additional lights should be provided on the object in such a way as to retain the general definition of the object to be lighted, the shielded light to be omitted if it does not contribute to the definition of the object to be lighted.

6.3.25 The top lights should be so arranged as to at least indicate the points or edges of the object highest in relation to the obstacle limitation surface. In the case of a chimney or other structures of like function, the top lights should be placed between 1.5 m and 3 m below the top. (See Figures 6-2 and 6-3). In the case of a guyed tower or antenna where it is not possible to locate a high-intensity obstacle light on the top, such a light should be located at the highest practicable point and a medium-intensity obstacle light showing white mounted on the top.

6.3.26 In the case of an extensive object or a group of closely spaced objects, top lights should be displayed at least on the points or edges of the objects highest in relation to the obstacle limitation surface, so as to indicate the general definition and extent of the objects. If two or more edges are of the same height, the edge nearest the landing area should be marked. Where low intensity lights are used, they should be spaced at intervals not to exceed 45 m. Where medium-intensity lights are used, they should be spaced at intervals not to exceed 90 m.

6.3.27 When the obstacle limitation surface concerned is sloping, and the highest point above the obstacle limitation surface is not the highest point of the object, additional obstacle lights should be placed on the highest part of the object.

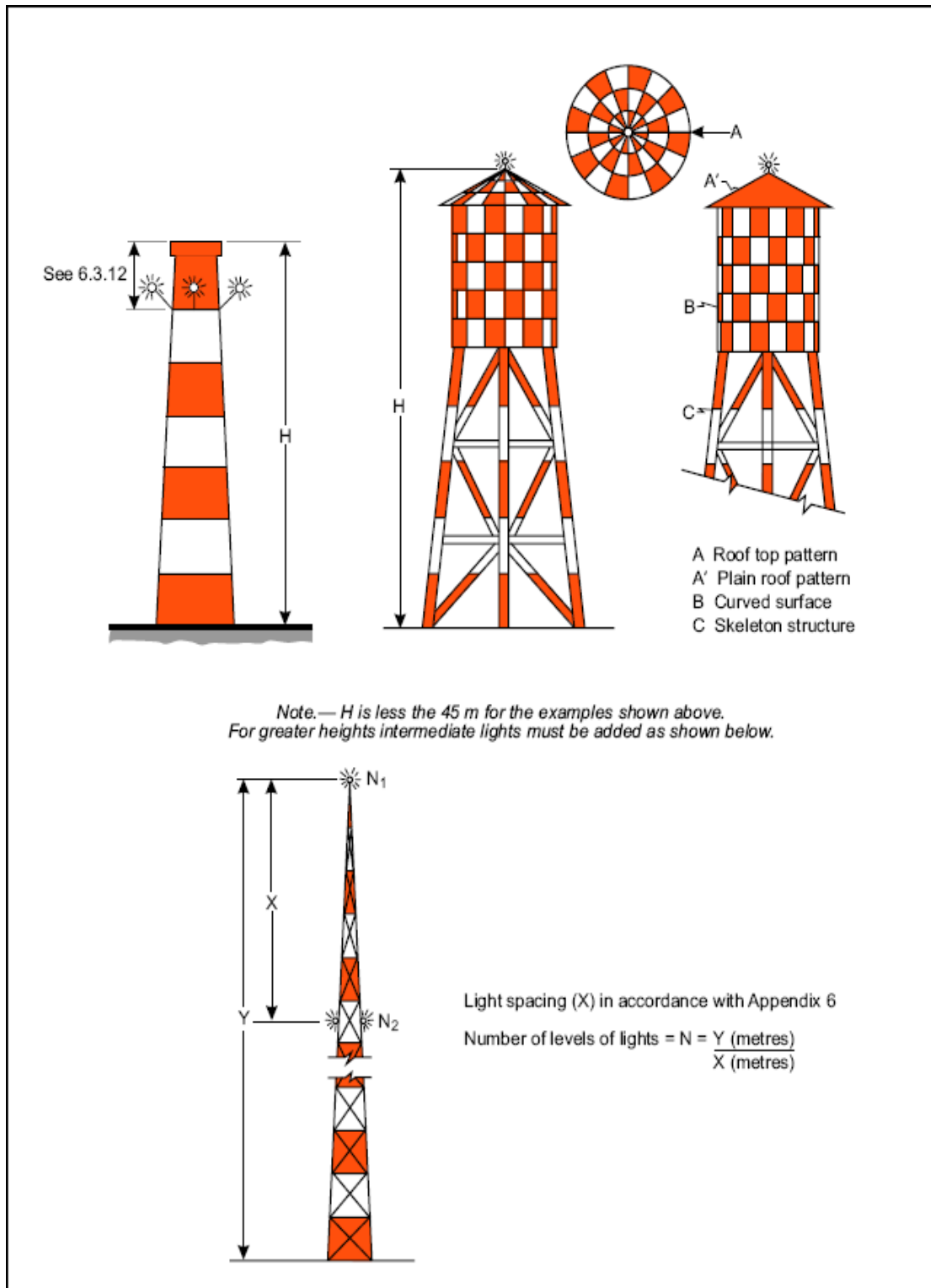

Figure 6-2 Examples of marking and lighting of tall structures

— Low-intensity obstacle light

6.3.28 Low-intensity obstacle lights on fixed objects, Type A and B, should be fixed red lights having an intensity sufficient to ensure conspicuity considering the intensity of the adjacent lights and the general level of illumination against which they would normally be viewed. In no case should the intensity be less than 10 cd of red light.

6.3.29 Low-intensity obstacle lights on mobile objects should be flashing lights, either red or, preferably, yellow. The flash frequency should be between 60 and 90 per minute. The effective intensity of the flash should not be less than 40 cd of red or yellow light.

It is an advantage to be able to distinguish between fixed and mobile objects, and this can be done by using fixed lights for fixed objects and flashing lights for mobile objects. It is also an advantage to be able to distinguish between aircraft and other mobile objects. Care is necessary to avoid an intensity which would be dazzling.

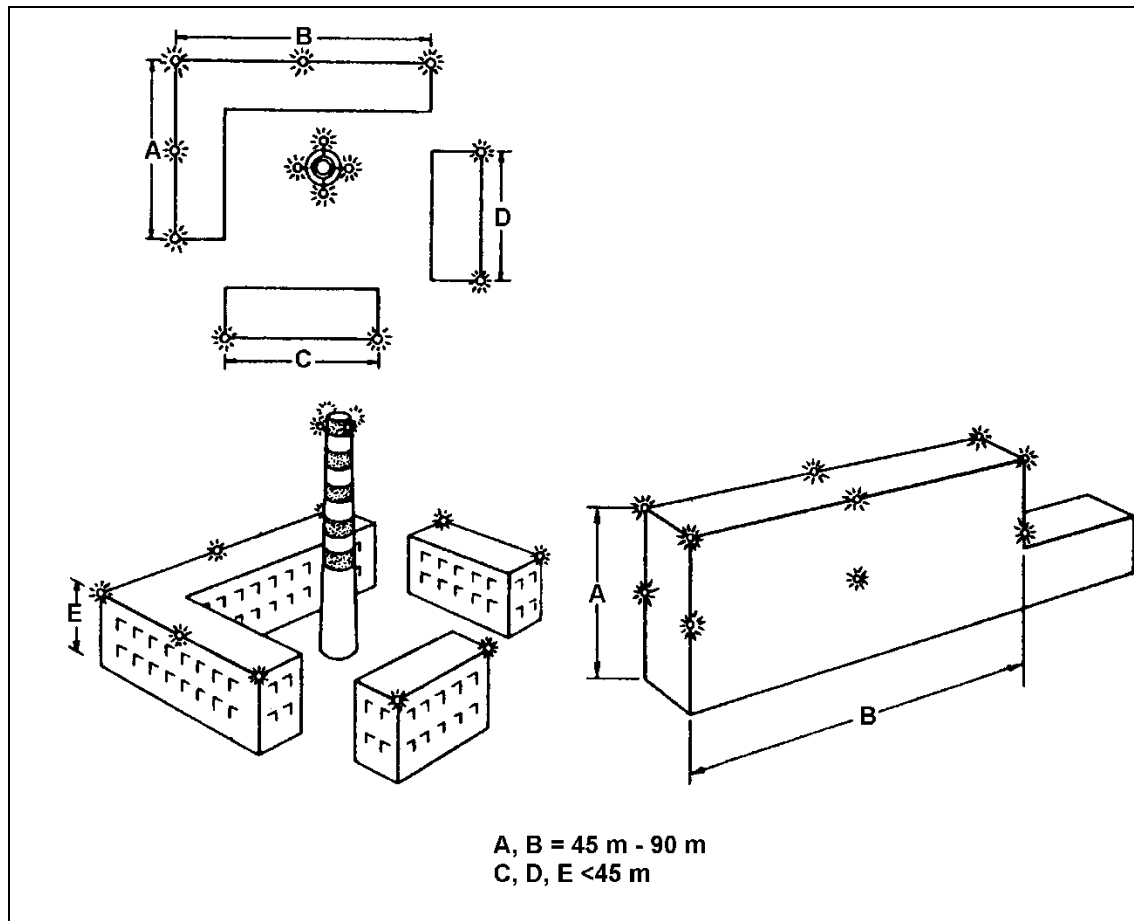

Figure 6-3 Lighting of Buildings

— **Medium-intensity obstacle lights**

6.3.30 Medium-intensity obstacle lights should be flashing red lights, except when used in conjunction with high-intensity obstacle lights they should be flashing white lights. The flash frequency should be between 20 and 60 per minute. The effective intensity of the flash should not be less than 1600 cd of red light.

— **High-intensity obstacle lights**

6.3.31 High-intensity obstacle lights should be flashing white lights. The effective intensity of a high-intensity obstacle light located on an object other than a tower supporting overhead wires or cables should be variable and dependent on the background luminance as follows:

Background luminance	Effective intensity
Above 500 cd/m ²	200 000 cd minimum
50 to 500 cd/m ²	20 000 ± 25% cd
Less than 50 cd/m ²	4000 ± 25% cd

6.3.32 The effective intensity of a high-intensity obstacle light located on a tower supporting overhead wires, cables, and suchlike, should be variable and dependent on the background luminance as follows:

Background luminance	Effective intensity
Above 500 cd/m ²	100 000 cd minimum
50 to 500 cd/m ²	20 000 ± 25% cd
Less than 50 cd/m ²	4000 ± 25% cd

6.3.33 High-intensity obstacle lights located on an object other than a tower supporting overhead wires, cables, etc., should flash simultaneously at a rate between 40 and 60 per minute.

6.3.34 High-intensity obstacle lights on a tower supporting overhead wires, cables, and suchlike should flash sequentially; first the middle light, second the top light and last, the bottom light. The intervals between flashes of the lights should approximate the following ratios:

Flash interval between	Ratio of cycle time
Middle and top light	1/13
Top and bottom light	2/13
Bottom and middle light	10/13

The cycle frequency should be 60 per minute.

Table 6-2 Characteristics of obstacle lights

1 Light Type	2 Colour	3 Signal type/ (flash rate)	4 Peak intensity (cd) at given Background Luminance		5 Peak intensity (cd) at given Background Luminance		6 Vertical Beam Spread (c)	8 Intensity (cd) at given Elevation Angles when the light unit is levelled (d)			
			Above 500 cd/m ²	N/A	50-500 cd/m ²	Below 50 cd/m ²		8 -10° (e)	9 -1° (f)	10 ±0° (f)	11 +6°
Low-intensity, Type A (fixed obstacle)	Red	Fixed	N/A	10 mmm	10 mmm	10°	—	—	±0° (f)	+6°	+10°
Low-intensity, Type B (fixed obstacle)	Red	Fixed	N/A	32 mmm	32 mmm	10°	—	—	—	32 mmm (g)	32 mmm (g)
Low-intensity, Type C (mobile obstacle)	Yellow/Blue (a)	Flashing (60-90 fpm)	N/A	40 mmm (b) 400 max	40 mmm (b) 400 max	12° (h)	—	—	—	—	—
Low-intensity, Type D Follow-me Vehicle	Yellow	Flashing (60-90 fpm)	N/A	200 mmm (b) 400 max	200 mmm (b) 400 max	12° (i)	—	—	—	—	—
Medium-intensity, Type A	White	Flashing (20-60 fpm)	20 000 (b) ± 25%	20 000 (b) ± 25%	2 000 (b) ± 25%	3° mmm	3% max	50% mmm 75% max	100% mmm	—	—
Medium-intensity, Type B	Red	Flashing (20-60 fpm)	N/A	N/A	2 000 (b) ± 25%	3° mmm	—	50% mmm 75% max	100% mmm	—	—
Medium-intensity, Type C	Red	Fixed	N/A	N/A	2 000 (b) ± 25%	3° mmm	—	50% mmm 75% max	100% mmm	—	—
High-intensity, Type A	White	Flashing (40-60 fpm)	200 000 (b) ± 25%	20 000 (b) ± 25%	2 000 (b) ± 25%	3°-7°	3% max	50% mmm 75% max	100% mmm	—	—
High-intensity, Type B	White	Flashing (40-60 fpm)	100 000 (b) ± 25%	20 000 (b) ± 25%	2 000 (b) ± 25%	3°-7°	3% max	50% mmm 75% max	100% mmm	—	—

Note.— This table does not include recommended horizontal beam spreads. 6.3.22 requires 360° coverage around an obstacle. Therefore, the number of lights needed to meet this requirement will depend on the horizontal beam spreads of each light as well as the shape of the obstacle. Thus, with narrower beam spreads, more lights will be required.

- a) See 6.3.25
- b) Effective intensity, as determined in accordance with the *Aerodrome Design Manual*, Part 4.
- c) Beam spread is defined as the angle between two directions in a plane for which the intensity is equal to 50% of the lower tolerance value of the intensity shown in columns 4, 5 and 6. The beam pattern is not necessarily symmetrical about the elevation angle at which the peak intensity occurs.
- d) Elevation (vertical) angles are referenced to the horizontal.
- e) Intensity at any specified horizontal radial as a percentage of the actual peak intensity at the same radial when operated at each of the intensities shown in columns 4, 5 and 6.
- f) Intensity at any specified horizontal radial as a percentage of the lower tolerance value of the intensity shown in columns 4, 5 and 6.
- g) In addition to specified values, lights shall have sufficient intensity to ensure conspicuity at elevation angles between ± 0° and 50°.
- h) Peak intensity should be located at approximately 2.5° vertical.
- i) Peak intensity should be located at approximately 17° vertical.

fpm — flashes per minute; N/A — not applicable

7. VISUAL AIDS FOR DENOTING RESTRICTED USE AREAS

7.1 Closed runways and taxiways, or parts thereof

The rule requirements for closed runways and taxiways are contained in Part 139, Appendix G.1.

— Application

7.1.1 A closed marking must be displayed on a runway or taxiway, or portion thereof, which is permanently closed to the use of all aircraft.

7.1.2 A closed marking should be displayed on a temporarily closed runway or taxiway or portion thereof, except that such marking may be omitted when the closing is of a short duration and adequate warning by air traffic services is provided.

— Location

7.1.3 On a runway a closed marking should be placed at the end of the runway, or portion declared closed, and additional markings should be placed at intervals not exceeding 300 m. On a taxiway a closed marking should be placed at each end of the taxiway or closed portion.

— Characteristics

7.1.4 The closed marking should be of the form and proportions as detailed in Figure 7-1, Illustration a), when displayed on a runway, and should be in the form and proportions as detailed in Figure 7-1 Illustration b), when displayed on a taxiway. The marking should be white when displayed on a runway and yellow when displayed on a taxiway.

If an area is closed temporarily, marking utilising materials other than paint may be suitable. Consideration should be given to the use of mobile “crosses” that are frangible and can be illuminated if required.

7.1.5 When a runway or taxiway or portion thereof is permanently closed all normal runway and taxiway markings should be obliterated and any lighting should be de-activated.

7.1.6 When a closed runway or taxiway is intercepted by a useable runway or taxiway the white crosses should be placed on each side of the useable surface and if the runway or taxiway is used at night then unserviceability lights should be placed across the entrance to the closed area at intervals not exceeding 3 m. See paragraph 7.4.4.

7.2 Non load-bearing surfaces

The rule requirements for non load bearing surfaces are contained in Part 139, Appendix G.2.

— Application

7.2.1 Shoulders for taxiways, holding bays and aprons and other non load-bearing surfaces which cannot readily be distinguished from load-bearing surfaces and which, if used by aircraft, might result in damage to the aircraft must have the boundary between such areas and the non load-bearing surface marked by a taxi side stripe marking.

The markings of runway sides are specified in paragraph 5.2.40.

— **Location**

7.2.2 A taxi side stripe marking should be placed along the edge of the load-bearing pavement, with the outer edge of the marking approximately on the edge of the load-bearing surface.

— **Characteristics**

7.2.3 A taxi side stripe marking should consist of a pair of solid lines, each 150 mm wide and spaced 150 mm apart and the same colour as the taxiway centre line marking.

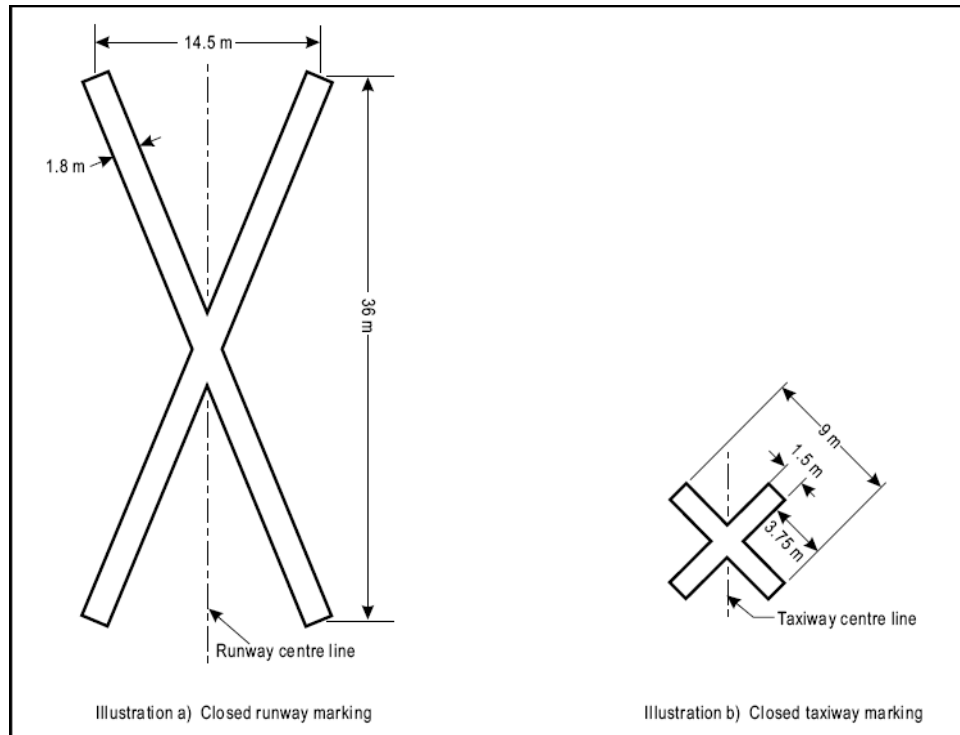

Figure 7-1 Closed runway and taxiway markings

7.3 Pre-threshold area

— **Application**

7.3.1 When the surface before a threshold is paved and exceeds 60 m in length and is not suitable for normal use by aircraft, the entire length before the threshold should be marked with a chevron marking.

— **Location**

7.3.2 A chevron marking should point in the direction of the runway and be placed as shown in Figure 7-2.

— **Characteristics**

7.3.3 A chevron marking should be of a conspicuous colour and contrast with the colour used for the runway markings, preferably yellow. It should have an overall width of at least 0.9 m.

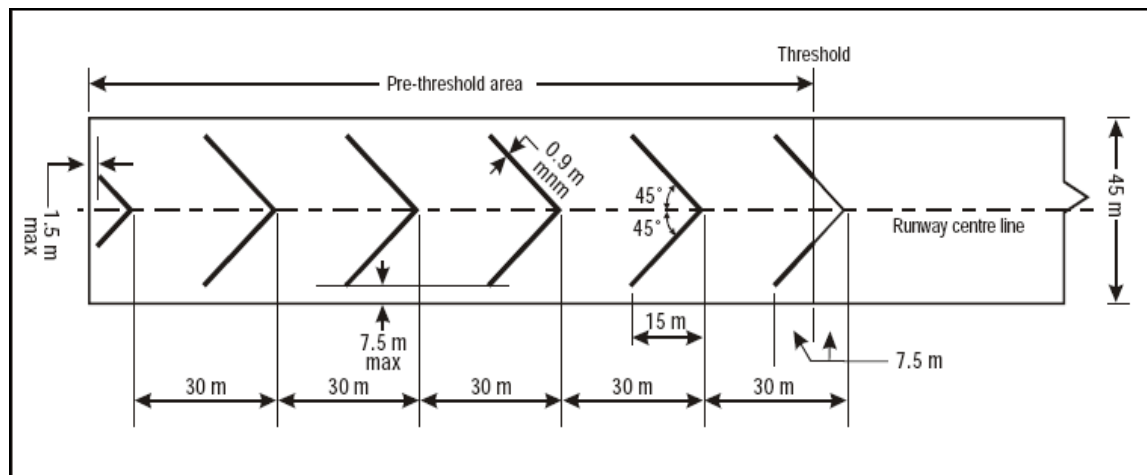

Figure 7-2 Pre-threshold marking

7.4 Unserviceable areas

The rule requirements for unserviceable areas are contained in Part 139, Appendix G.3.

Application

7.4.1 Unserviceability markers must be displayed wherever any portion of a taxiway, apron or holding bay is unfit for the movement of aircraft but it is still possible for aircraft to bypass the area safely. On a movement area used at night, unserviceability lights must be used.

Unserviceability markers are used for such purposes as warning pilots of a hole in a taxiway or apron pavement or outlining a portion of pavement that is under repair. They are not suitable for use when a portion of a runway becomes unserviceable, nor on a taxiway when a major portion of the width becomes unserviceable. In such instances, the runway or taxiway should be closed.

Location

7.4.2 Unserviceability markers should be placed at intervals sufficiently close so as to delineate the unserviceable area.

Characteristics

7.4.3 Unserviceability markers should consist of conspicuous upstanding devices such as flags, cones, lights or marker boards or tyres.

Characteristics of unserviceability lights

7.4.4 An unserviceability light should consist of a red fixed light or a red or yellow flashing light. The red fixed light should have an intensity sufficient to ensure conspicuity considering the intensity of the adjacent lights and the general level of illumination against which it would normally be viewed. The red or yellow flashing light should have an effective intensity of not less than 5 cd.

It is advisable that flashing unserviceability lights be distinguishable from the flashing lights used to mark mobile objects or aircraft. Features which provide differentiation are random flashing of a number of such lights, their size, position and intensity and their ratio of on-to-off time.

Characteristics of unserviceability cones

7.4.5 An unserviceability cone should not exceed 0.5 m in height and should be coloured red, orange or yellow or any one of these colours in combination with white.

Characteristics of unserviceability flags

7.4.6 An unserviceability flag should be at least 0.5 m square and red, orange or yellow or any one of these colours in combination with white.

Characteristics of unserviceability marker boards or tyres

7.4.7 An unserviceability marker board or tyre should be painted white. A marker board should not exceed 0.5 m in height and 0.9 m in width. If longer than 3 m in length, the marker board should be marked with alternate red and white or orange and white vertical stripes. A marker board can be free standing (non-secured) if it has been suitably tested to withstand wind speeds of over 100km/hour

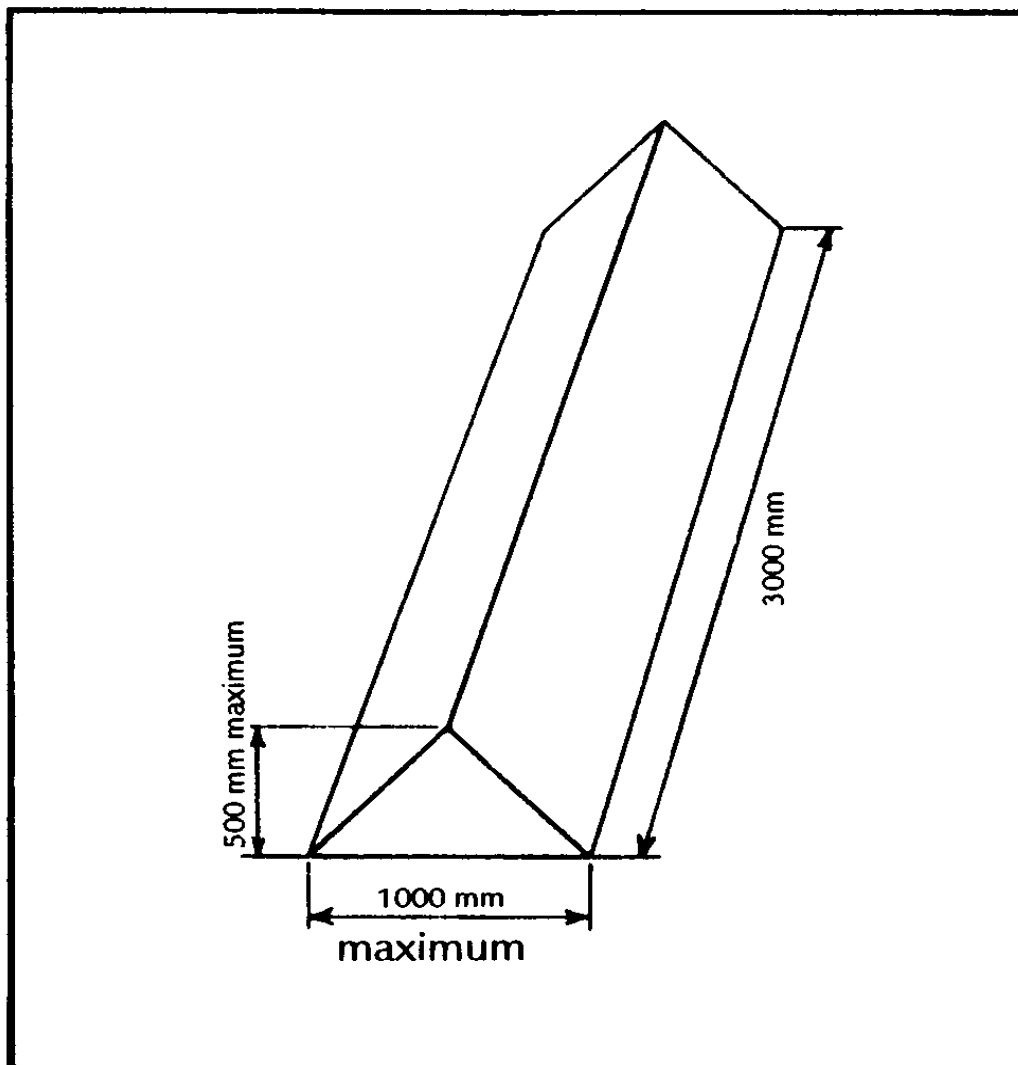

8. EQUIPMENT AND INSTALLATIONS

The rule requirements for power supply systems for air navigation facilities are contained in Part 139, Appendix H.1.

8.1 Secondary power supply

— General

Application

8.1.1 A secondary power supply should be provided, capable of supplying the power requirements of at least the aerodrome facilities listed below:

- (a) the signalling lamp and the minimum lighting necessary to enable air traffic services personnel to carry out their duties

The requirement for minimum lighting may be met by other than electrical means.

- (b) all obstacle lights which are essential to ensure the safe operation of aircraft
- (c) approach, runway and taxiway lighting as specified in paragraphs 8.1.5 to 8.1.8
- (d) meteorological equipment
- (e) essential equipment and facilities for the aerodrome responding emergency agencies
- (f) floodlighting on a designated isolated parking position if provided in accordance with paragraph 5.3.183.

Characteristics

8.1.2 Electric power supply connections to those facilities for which secondary power is required should be so arranged that the facilities are automatically connected to the secondary power supply on failure of the normal supply of power.

8.1.3 The time interval between failure of the normal source of power and the complete restoration of the services required by paragraph 8.1.1 should be as short as practicable and should not exceed two minutes, except that for visual aids the requirements of Part 139, Appendix H, Table H.1, should apply.

8.1.4 Requirements for a secondary power supply should be met by either of the following:

- (a) independent public power, which is a source of power supplying the aerodrome service from a substation other than the normal substation through a transmission line following a route different from the normal power supply route and such that the possibility of a simultaneous failure of the normal and independent public power supplies is extremely remote: or
- (b) standby power unit(s), which are engine generators, batteries, or otherwise, from which electric power can be obtained.

— Visual Aids

Application

8.1.5 At an aerodrome where the primary runway is a non-instrument runway, a secondary power supply capable of meeting the requirements of Part 139, Appendix H, Table H.1, should be provided.

8.1.6 At an aerodrome where the primary runway is a non-precision approach runway, a secondary power supply capable of meeting the requirements of Table 8-1 should be provided except that a secondary power supply for visual aids need not be provided for more than one precision approach runway.

8.1.7 For a precision approach runway, a secondary power supply capable of meeting the requirements of Part 139, Appendix H, Table H.1, for the appropriate category of precision approach runway should be provided. Electric power supply connections to those facilities for which secondary power is required should be so arranged that the facilities are automatically connected to the secondary power supply on failure of the normal source of power.

8.1.8 For the take-off runway intended for use in runway visual range conditions less than a value in order of 400 m, a secondary power supply capable of meeting the requirements of Part 139, Appendix H, Table H.1, should be provided.

8.2 Circuit design

The rule requirements for circuit design are contained in Part 139, Appendix H.3.

8.2.1 For a runway meant for use in runway visual range conditions less than a value of 550 m, the electrical circuits for the main power supply, lighting and control of the lighting systems included in Part 139, Appendix H, Table H.1, must be so designed that an equipment failure will not leave the pilot without visual guidance or will not result in a misleading pattern.

8.2.2 Where a runway forming part of a standard taxi route is provided with runway lighting and taxiway lighting, the lighting systems must be interlocked to preclude the possibility of simultaneous operation of both forms of lighting.

8.3 Monitoring

The rule requirements for monitoring are contained in Part 139, Appendix H.4.

8.3.1 A system of monitoring visual aids should be employed to ensure lighting system reliability.

8.3.2 Where lighting systems are used for aircraft control purposes, such systems must be monitored automatically to provide an immediate indication of any fault which may affect the control functions. This information must be automatically relayed to the air traffic service unit.

8.3.3 For a runway meant for use in runway visual range conditions less than a value of 550 m, the lighting systems detailed in Part 139, Appendix H, Table H.1, should be monitored so as to provide an immediate indication when the serviceability level of any element falls below the minimum serviceability level specified in paragraphs 8.6.7 to 8.6.11 as appropriate. This information should be immediately relayed to the maintenance crew.

8.3.4 For a runway meant for use in runway visual range conditions less than a value of 550 m, the lighting systems detailed in Part 139, Appendix H, Table H.1, should be monitored automatically to provide an immediate indication when the serviceability level of any element falls below the minimum level specified by the appropriate authority below which operations

should not continue. This information should be automatically relayed to the air traffic services unit and displayed in a prominent position.

8.4 Siting and construction of equipment and installations on operational areas

Requirements for obstacle limitation surfaces are specified in subsection 4.2

The design of light fixtures and their supporting structures, light units of visual approach slope indicators, signs, and markers, is specified in section 5.

8.4.1 Unless its function requires it to be there for air navigation purposes, no equipment or installation should be:

- (a) on a runway strip, a runway end safety area, a taxiway strip or within the distances specified in Table 3-1, column 11, if it would endanger an aircraft; or
- (b) on a clearway if it would endanger an aircraft in the air; or
- (c) derogate the operation of an electric or visual navigation aid or air traffic service on the aerodrome.

8.4.2 Any equipment or installation required for air navigation purposes which must be located in an area identified above should be regarded as an obstacle and should be of minimum practicable mass and height, frangible designed and mounted, and sited in such a manner as to reduce the hazard to aircraft to a minimum.

8.4.3 Any equipment or installation required for air navigation purposes which must be located on or near a strip of a precision approach runway category I, II or III and which:

- (a) situated on that portion of the strip within 77.5 m of the runway centre line where the code number is 4 and the code letter is F:
- (b) is situated within 240m from the end of the strip and within:
 - (i) 60 m of the runway centre line where the code number is 3 or 4; or
 - (ii) 45 m of the runway centre line where the code number is 1 or 2; or
- (c) penetrates the inner approach surface, the inner transitional surface or the balked landing surface.

Should be of minimum practicable mass and height, frangible designed and mounted, and sited in such a manner as to reduce the hazard to aircraft to a minimum.

8.4.4 Any equipment or installation required for air navigation purposes which is an obstacle of operational significance in accordance with paragraph 4.2.4, or paragraph 4.2.11, should be frangible and mounted as low as possible.

8.5 Surface movement guidance and control systems

Application

8.5.1 A surface movement guidance and control system should be provided at an aerodrome.

Characteristics

8.5.2 The design of a surface movement guidance and control system should take into account:

- (a) the density of air traffic:
- (b) the visibility conditions under which operations are intended:
- (c) the need for pilot orientation:
- (d) the complexity of the aerodrome layout:
- (e) movements of vehicles.

8.5.3 The visual aid components of a surface movement guidance and control system, i.e. markings, lights and signs should be designed to conform with the relevant specifications in subsections 5.2, 5.3 and 5.4, respectively.

8.5.4 A surface movement guidance and control system should be designed to assist in the prevention of inadvertent incursions of aircraft and vehicles onto an active runway.

8.5.5 The system should be designed to assist in the prevention of collisions between aircraft, and between aircraft and vehicles or objects, on any part of the movement area.

8.5.6 Where a surface movement guidance and control system is provided by selective switching of stop bars and taxiway centre line lights, the following requirements should be met:

- (a) taxiway routes which are indicated by illuminated taxiway centre line lights should be capable of being terminated by an illuminated stop bar
- (b) the control circuits should be so arranged that when a stop bar located ahead of an aircraft is illuminated the appropriate section of taxiway centre line lights beyond it is suppressed
- (c) the taxiway centre line lights are activated ahead of an aircraft when the stop bar is suppressed.

Note: See paragraphs 5.3.164 and 5.3.171 for specifications on taxiway centre line lights and stop bars, respectively.

8.5.7 A surface movement surveillance system for the manoeuvring area should be provided at an aerodrome intended for use in runway visual range conditions less than a value of 350 m.

8.5.8 A surface movement surveillance system for the manoeuvring area should be provided at an aerodrome other than that in paragraph 8.5.7 when traffic density and operating conditions are such that regularity of traffic flow cannot be maintained by alternative procedures and facilities.

8.6 Visual aids

Note: These specifications are intended to define the maintenance performance level objectives. They are not intended to define whether the lighting system is operationally out of service.

8.6.1 A light should be deemed to be unserviceable when the main beam average intensity is less than 50% of the value specified in the appropriate figure in Appendix 2 of this AC. For light

units where the designed main beam average intensity is above the value shown in Appendix 2 of this AC, the 50% value should be related to that design value.

8.6.2 A system of preventive maintenance of visual aids should be employed to ensure lighting and marking system reliability.

8.6.3 The system of preventive maintenance employed for a precision approach runway category II or III should include at least the following checks:

- (a) visual inspection and in-field measurement of the intensity, beam spread and orientation of lights included in the approach and runway lighting systems
- (b) control and measurement of the electrical characteristics of each circuitry included in the approach and runway lighting systems
- (c) control of the correct functioning of light intensity settings used by air traffic control.

8.6.4 In-field measurement of intensity, beam spread and orientation of lights included in approach and runway lighting systems for a precision approach runway category II or III should be undertaken by measuring all lights, as far as practicable, to ensure conformance with the applicable specification of Appendix 2 of this AC.

8.6.5 Measurement of intensity, beam spread and orientation of lights included in approach and runway lighting systems for a precision approach runway category II or III should be undertaken using a mobile measuring unit of sufficient accuracy to analyse the characteristics of the individual lights.

8.6.6 The frequency of measurement of lights for a precision approach runway category II or III should be based on traffic density, the local pollution level, the reliability of the installed lighting equipment and the continuous assessment of the results of the in-field measurements but, in any event, should not be less than twice a year for in-pavement lights and not less than once a year for other lights.

8.6.7 The system of preventive maintenance employed for a precision approach runway category II or III must have as its objective that, during any period of category II or III operations, all approach and runway lights are serviceable and that, in any event, at least:

- (a) 95% of the lights are serviceable in each of the following particular significant elements—
 - (i) precision approach category II and III lighting system, the inner 450 m
 - (ii) runway centre line lights
 - (iii) runway threshold lights
 - (iv) runway edge lights
- (d) 90% of the lights are serviceable in the touchdown zone lights
- (b) 85% of the lights are serviceable in the approach lighting system beyond 450 m
- (c) 75% of the lights are serviceable in the runway end lights.

In order to provide continuity of guidance, the allowable percentage of unserviceable lights must not be permitted in such a way as to alter the basic pattern of the lighting system. Additionally, an

unserviceable light must not be permitted adjacent to another unserviceable light, except in a barrette or a crossbar where two adjacent unserviceable lights may be permitted.

Note: *With respect to barrettes, crossbars and runway edge lights, lights are considered to be adjacent if located consecutively and:*

— *laterally: in the same barrette or crossbar:*

— *longitudinally: in the same row of edge lights or barrettes.*

8.6.8 The system of preventive maintenance employed for a stop bar provided at a runway-holding position used in conjunction with a runway intended for operations in runway visual range conditions less than a value of 350 m should have the following objectives:

- (a) no more than two lights will remain unserviceable
- (b) two adjacent lights will not remain unserviceable unless the light spacing is significantly less than that specified.

8.6.9 The system of preventive maintenance employed for a taxiway intended for use in runway visual range conditions less than a value of 350 m should have as its objective that no two adjacent taxiway centre line lights be unserviceable.

8.6.10 The system of preventive maintenance employed for a precision approach runway category I should have as its objective that, during any period of category I operations, all approach and runway lights are serviceable and that, in any event, at least 85% of the lights are serviceable in each of the following:

- (a) precision approach category I lighting system
- (b) runway threshold lights
- (c) runway edge lights
- (d) runway end lights.

In order to provide continuity of guidance an unserviceable light must not be permitted adjacent to another unserviceable light unless the light spacing is significantly less than that specified.

Note: *In barrettes and crossbars, guidance is not lost by having two adjacent unserviceable lights.*

8.6.11 The system of preventive maintenance employed for a runway meant for take-off in runway visual range conditions less than a value of 550 m should have as its objective that, during any period of operations, all runway lights are serviceable and that in any event:

- (a) at least 95% of the lights are serviceable in the runway centre line lights (where provided) and in the runway edge lights
- (b) at least 75% of the lights are serviceable in the runway end lights.

In order to provide continuity of guidance, an unserviceable light must not be permitted adjacent to another unserviceable light.

8.6.12 The system of preventive maintenance employed for a runway meant for take-off in runway visual range conditions of a value of 550 m or greater should have as its objective that,

during any period of operations, all runway lights are serviceable and that, in any event, at least 85% of the lights are serviceable in the runway edge lights and runway end lights. In order to provide continuity of guidance, an unserviceable light must not be permitted adjacent to another unserviceable light.

8.6.13 During low visibility procedures, construction or maintenance activities should be restricted in the proximity of aerodrome electrical systems.

APPENDICES

- Appendix 1 Colours for aeronautical ground lights, markings, signs and panels
- Appendix 2 Aeronautical ground light characteristics
- Appendix 3 Mandatory instruction markings and information markings
- Appendix 4 Requirements concerning design of taxiing signs
- Appendix 5 Aeroplane characteristics

Appendix 1 Colours for aeronautical ground lights, markings, signs and panels

1. General

Introductory Note: *The following specifications define the chromaticity limits of colours to be used for aeronautical ground lights, markings, signs and panels. The specifications are in accord with the 1983 specifications of the International Commission on Illumination (CIE).*

It is not possible to establish specifications for colours such that there is no possibility of confusion. For reasonably certain recognition, it is important that the eye illumination be well above the threshold of perception, that the colour not be greatly modified by selective atmospheric attenuations and that the observer's colour vision be adequate. There is also a risk of confusion of colour at an extremely high level of eye illumination such as may be obtained from a high-intensity source at very close range. Experience indicates that satisfactory recognition can be achieved if due attention is given to these factors.

The chromaticities are expressed in terms of the standard observer and coordinate system adopted by the International Commission on Illumination (CIE) at its Eighth Session at Cambridge, England, in 1931. (See CIE Publication No. 15, Colorimetry(1971)).

2. Colours for aeronautical ground lights

2.1 Chromaticity's

2.1.1 The chromaticity's of aeronautical ground lights must be within the following boundaries:

CIE Equations (see Figure A1-1):

- (a) Red
 - Purple boundary $y = 0.980 - x$
 - Yellow boundary $y = 0.335$
- (b) Yellow
 - Red boundary $y = 0.382$
 - White boundary $y = 0.790 - 0.667x$
 - Green boundary $y = x - 0.120$
- (c) Green
 - Yellow boundary $x = 0.360 - 0.080y$
 - White boundary $x = 0.650y$
 - Blue boundary $y = 0.390 - 0.171x$
- (d) Blue ~
 - Green boundary $y = 0.805x + 0.065$
 - White boundary $y = 0.400 - x$
 - Purple boundary $x = 0.600y + 0.133$
- (e) White
 - Yellow boundary $x = 0.500$
 - Blue boundary $x = 0.285$
 - Green boundary $y = 0.440$
 - and $y = 0.150 + 0.640x$

Purple boundary $y = 0.050 + 0.750x$
and $y = 0.382$

(f) Variable white

Yellow boundary $x = 0.255 + 0.750y$
and $x = 1.185 - 1.500y$

Blue boundary $x = 0.285$

Green boundary $y = 0.440$

and $y = 0.150 + 0.640x$

Purple boundary $y = 0.050 + 0.750x$

and $y = 0.382$

Note: *Guidance on chromaticity changes resulting from the effect of temperature on filtering elements is given in the Aerodrome Design Manual (ICAO Doc 9157), Part 4.*

2.1.2 Where dimming is not required, or where observers with defective colour vision must be able to determine the colour of the light, green signals should be within the following boundaries:

Yellow boundary $y = 0.726 - 0.726x$

White boundary $x = 0.650y$

Blue boundary $y = 0.390 - 0.171x$

2.1.3 Where increased certainty of recognition is more important than maximum visual range, green signals should be within the following boundaries—

Yellow boundary $y = 0.726 - 0.726x$

White boundary $x = 0.625y - 0.041$

Blue boundary $y = 0.390 - 0.171x$

2.2 Discrimination between lights

2.2.1 If there is a requirement to discriminate yellow and white from each other, they should be displayed in close proximity of time or space as, for example, by being flashed successively from the same beacon.

2.2.2 If there is a requirement to discriminate yellow from green and/or white, as for example on exit taxiway centre line lights, the y coordinates of the yellow light should not exceed a value of 0.40.

Note: *The limits of white have been based on the assumption that they will be used in situations in which the characteristics (colour temperature) of the light source will be substantially constant.*

2.2.3 The colour variable white is intended to be used only for lights that are to be varied in intensity, e.g. to avoid dazzling. If this colour is to be discriminated from yellow, the lights should be so designed and operated that:

- (a) the x coordinate of the yellow is at least 0.050 greater than the x coordinate of the white
- (b) the disposition of the lights will be such that the yellow lights are displayed simultaneously and in close proximity to the white lights.

2.2.4 The colour of aeronautical ground lights should be verified as being within the boundaries specified in Figure A1-1 by measurement at five points within the area limited by the innermost isocandela curve (isocandela diagrams in Appendix 2 of this AC refer), with operation at

rated current or voltage. In the case of elliptical or circular isocandela curves, the colour measurements must be taken at the centre and at the horizontal and vertical limits. In the case of rectangular isocandela curves, the colour measurements must be taken at the centre and the limits of the diagonals (corners). In addition, the colour of the light must be checked at the outermost isocandela curve to ensure that there is no colour shift that might cause signal confusion to the pilot.

Note 1: *For the outermost isocandela curve, a measurement of colour coordinates should be made and recorded for review and judgement of acceptability by the appropriate authority.*

Note 2: *Certain light units may have application so that they may be viewed and used by pilots from directions beyond that of the outermost isocandela curve (e.g. stop bar lights at significantly wide runway-holding positions). In such instances, the appropriate authority should assess the actual application and if necessary require a check of colour shift at angular ranges beyond the outermost curve.*

2.2.5 In the case of visual approach slope indicators and other light units having a colour transition sector, the colour should be measured at points in accordance with paragraph 2.2.4, except that the colour areas should be treated separately and no point should be within 0.5° of the transition sector.

3. Colours for markings, signs and panels

Note 1: *The specifications of surface colours given below apply only to freshly coloured surfaces. Colours used for markings, signs and panels usually change with time and therefore require renewal.*

Note 2: *Guidance on surface colours is contained in the CIE document entitled "Recommendations for Surface Colours for Visual Signalling -Publication No. 39-2 (TC-106) 1983".*

Note 3: *The specifications recommended in subsection 3.4 for transilluminated panels are interim in nature and are based on the CIE specifications for transilluminated signs. It is intended that these specifications will be reviewed and updated as and when CIE develops specifications for transilluminated panels.*

3.1 The chromaticities and luminance factors of ordinary colours, colours of retroreflective materials and colours of Trans illuminated (internally illuminated) signs and panels should be determined under the following standard conditions:

- (a) angle of illumination: 45°
- (b) direction of view: perpendicular to surface
- (c) illuminant: CIE standard illuminant D₆₅.

3.2 The chromaticity and luminance factors of ordinary colours for markings and externally illuminated signs and panels should be within the following boundaries when determined under standard conditions.

CIE Equations (see Figure AI-2):

- (a) Red
- | | |
|------------------|----------------------|
| Purple boundary | $y = 0.345 - 0.051x$ |
| White boundary | $y = 0.910 - x$ |
| Orange boundary | $y = 0.314 + 0.047x$ |
| Luminance factor | $\beta = 0.07$ (mnm) |
- (b) Orange
- | | |
|------------------|----------------------|
| Red boundary | $y = 0.285 + 0.100x$ |
| White boundary | $y = 0.940 - x$ |
| Yellow boundary | $y = 0.250 + 0.220x$ |
| Luminance factor | $\beta = 0.20$ (mnm) |
- (c) Yellow
- | | |
|------------------|----------------------|
| Orange boundary | $y = 0.108 + 0.707x$ |
| White boundary | $y = 0.910 - x$ |
| Green boundary | $y = 1.35x - 0.093$ |
| Luminance factor | $\beta = 0.45$ (mnm) |
- (d) White
- | | |
|------------------|----------------------|
| Purple boundary | $y = 0.010 + x$ |
| Blue boundary | $y = 0.610 - x$ |
| Green boundary | $y = 0.030 + x$ |
| Yellow boundary | $y = 0.710 - x$ |
| Luminance factor | $\beta = 0.75$ (mnm) |
- (e) Black
- | | |
|------------------|----------------------|
| Purple boundary | $y = x - 0.030$ |
| Blue boundary | $y = 0.570 - x$ |
| Green boundary | $y = 0.050 + x$ |
| Yellow boundary | $y = 0.740 - x$ |
| Luminance factor | $\beta = 0.03$ (max) |
- (f) Yellowish green
- | | |
|-----------------|--------------------|
| Green boundary | $y = 1.317x + 0.4$ |
| White boundary | $y = 0.910 - x$ |
| Yellow boundary | $y = 0.867x + 0.4$ |
- (g) Green
- | | |
|------------------|----------------------|
| Yellow boundary | $x = 0.313$ |
| White boundary | $y = 0.243 + 0.670x$ |
| Blue boundary | $y = 0.493 - 0.524x$ |
| Luminance factor | $\beta = 0.10$ (mnm) |

Note: *The small separation between surface red and surface orange is not sufficient to ensure the distinction of these colours when seen separately.*

3.3 The chromaticity and luminance factors of colours of retroreflective materials for markings, signs and panels should be within the following boundaries when determined under standard conditions.

CIE Equations (see FigureAI-3):

- (a) Red
- | | |
|-----------------|----------------------|
| Purple boundary | $y = 0.345 - 0.051x$ |
|-----------------|----------------------|

- | | |
|------------------|----------------------|
| White boundary | $y = 0.910 - x$ |
| Orange boundary | $y = 0.314 + 0.047x$ |
| Luminance factor | $\beta = 0.03$ (mnm) |
- (b) Orange
- | | |
|------------------|----------------------|
| Red boundary | $y = 0.265 + 0.205x$ |
| White boundary | $y = 0.910 - x$ |
| Yellow boundary | $y = 0.207 + 0.390x$ |
| Luminance factor | $\beta = 0.14$ (mnm) |
- (c) Yellow
- | | |
|------------------|----------------------|
| Orange boundary | $y = 0.160 + 0.540x$ |
| White boundary | $y = 0.910 - x$ |
| Green boundary | $y = 1.35x - 0.093$ |
| Luminance factor | $\beta = 0.16$ (mnm) |
- (d) White
- | | |
|------------------|----------------------|
| Purple boundary | $y = x$ |
| Blue boundary | $y = 0.610 - x$ |
| Green boundary | $y = 0.040 + x$ |
| Yellow boundary | $y = 0.710 - x$ |
| Luminance factor | $\beta = 0.27$ (mnm) |
- (e) Blue
- | | |
|------------------|----------------------|
| Green boundary | $y = 0.118 + 0.675x$ |
| White boundary | $y = 0.370 - x$ |
| Purple boundary | $y = 1.65x - 0.187$ |
| Luminance factor | $\beta = 0.01$ (mnm) |
- (f) Green
- | | |
|------------------|----------------------|
| Yellow boundary | $y = 0.711 - 1.22x$ |
| White boundary | $y = 0.243 + 0.670x$ |
| Blue boundary | $y = 0.405 - 0.243x$ |
| Luminance factor | $\beta = 0.03$ (mnm) |

3.4 The chromaticity and luminance factors of colours for luminescent or Trans illuminated (internally illuminated) signs and panels should be within the following boundaries when determined under standard conditions.

CIE Equations (see Figure AI-4):

- (a) Red
- | | |
|---------------------------|----------------------|
| Purple boundary | $y = 0.345 - 0.051x$ |
| White boundary | $y = 0.910 - x$ |
| Orange boundary | $y = 0.314 + 0.047x$ |
| Luminance factor | $\beta = 0.07$ (mnm) |
| (day condition) | |
| Relative luminance | 5% (mnm) |
| to white (night 20% (max) | |
| condition) | |
- (b) Yellow
- | | |
|-----------------|----------------------|
| Orange boundary | $y = 0.108 + 0.707x$ |
| White boundary | $y = 0.910 - x$ |

Green boundary $y = 1.35x - 0.093$
 Luminance factor $\beta = 0.45$ (mnm)
 (day condition)
 Relative luminance 30% (mnm)
 to white (night 80% (max)
 condition)

(c) White

Purple boundary $y = 0.010 + x$
 Blue boundary $y = 0.610 - x$
 Green boundary $y = 0.030 + x$
 Yellow boundary $y = 0.710 - x$
 Luminance factor $\beta = 0.75$ (mnm)
 (day condition)
 Relative luminance 100%
 to white (night condition)

(d) Black

Purple boundary $y = x - 0.030$
 Blue boundary $y = 0.570 - x$
 Green boundary $y = 0.050 + x$
 Yellow boundary $y = 0.740 - x$
 Luminance factor $\beta = 0.03$ (max)
 (day condition)
 Relative luminance 0% (mnm)
 to white (night 2% (max)
 condition)

(e) Green

Yellow boundary $x = 0.313$
 White boundary $y = 0.243 + 0.670x$
 Blue boundary $y = 0.493 - 0.524x$
 Luminance factor: $\beta = 0.10$ minimum
 (day conditions)
 Relative luminance 5% (minimum)
 to white (night 30% (maximum)
 conditions)

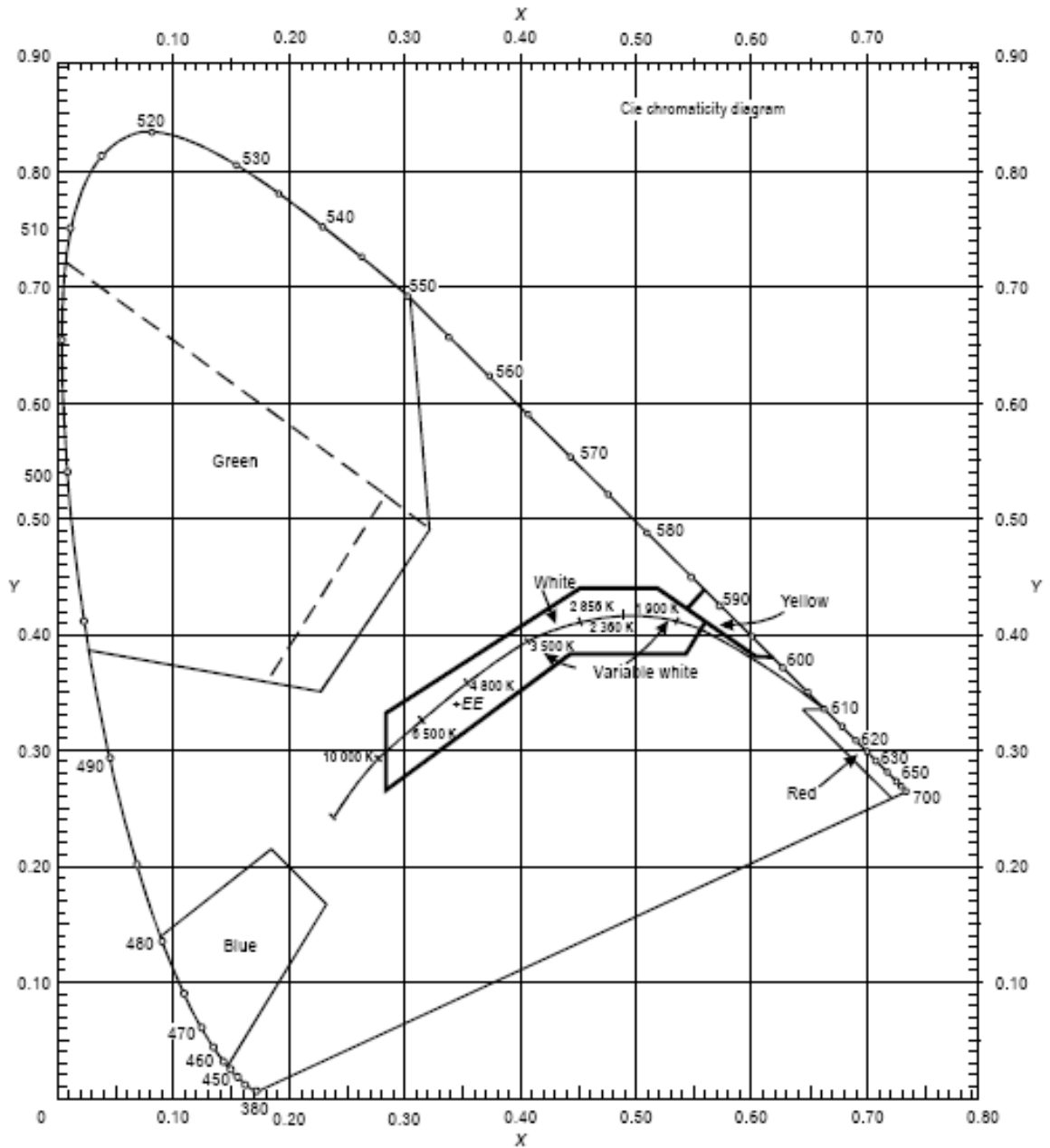

Figure A1-1. Colours for aeronautical ground lights

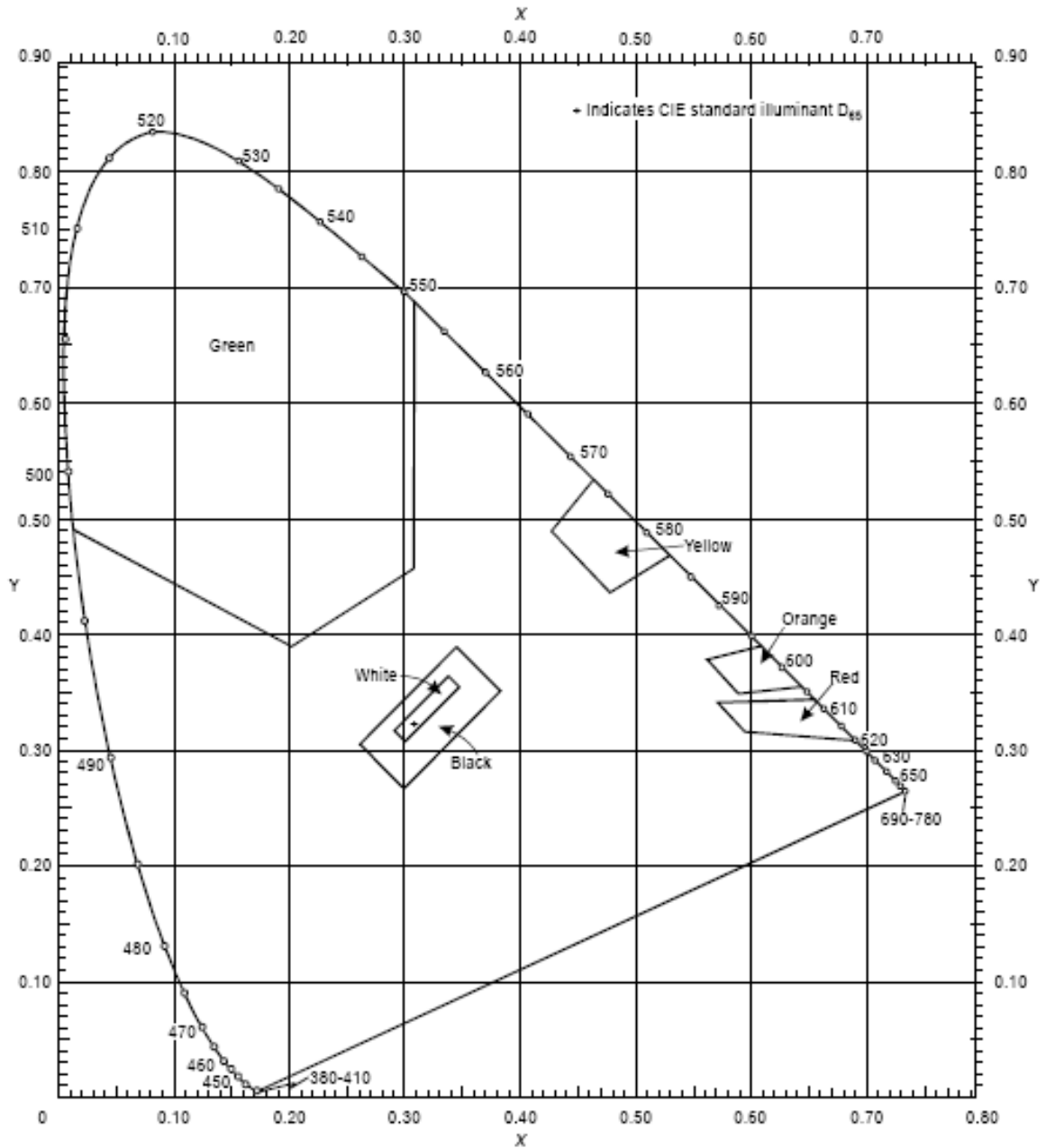

Figure A1-2. Ordinary colours for markings and externally illuminated signs and panels

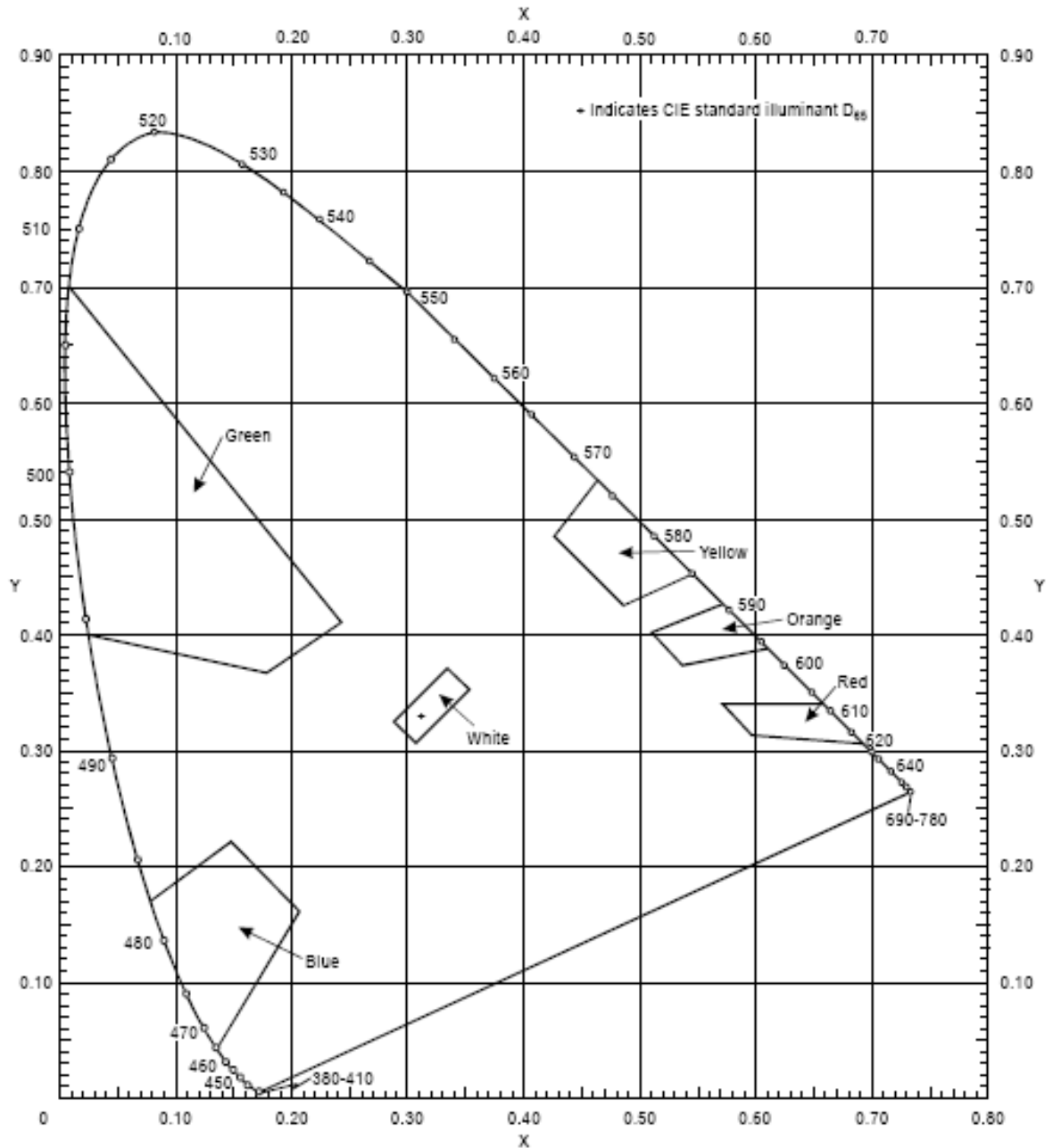

Figure A1-3. Colours of retroreflective materials for markings, signs and panels

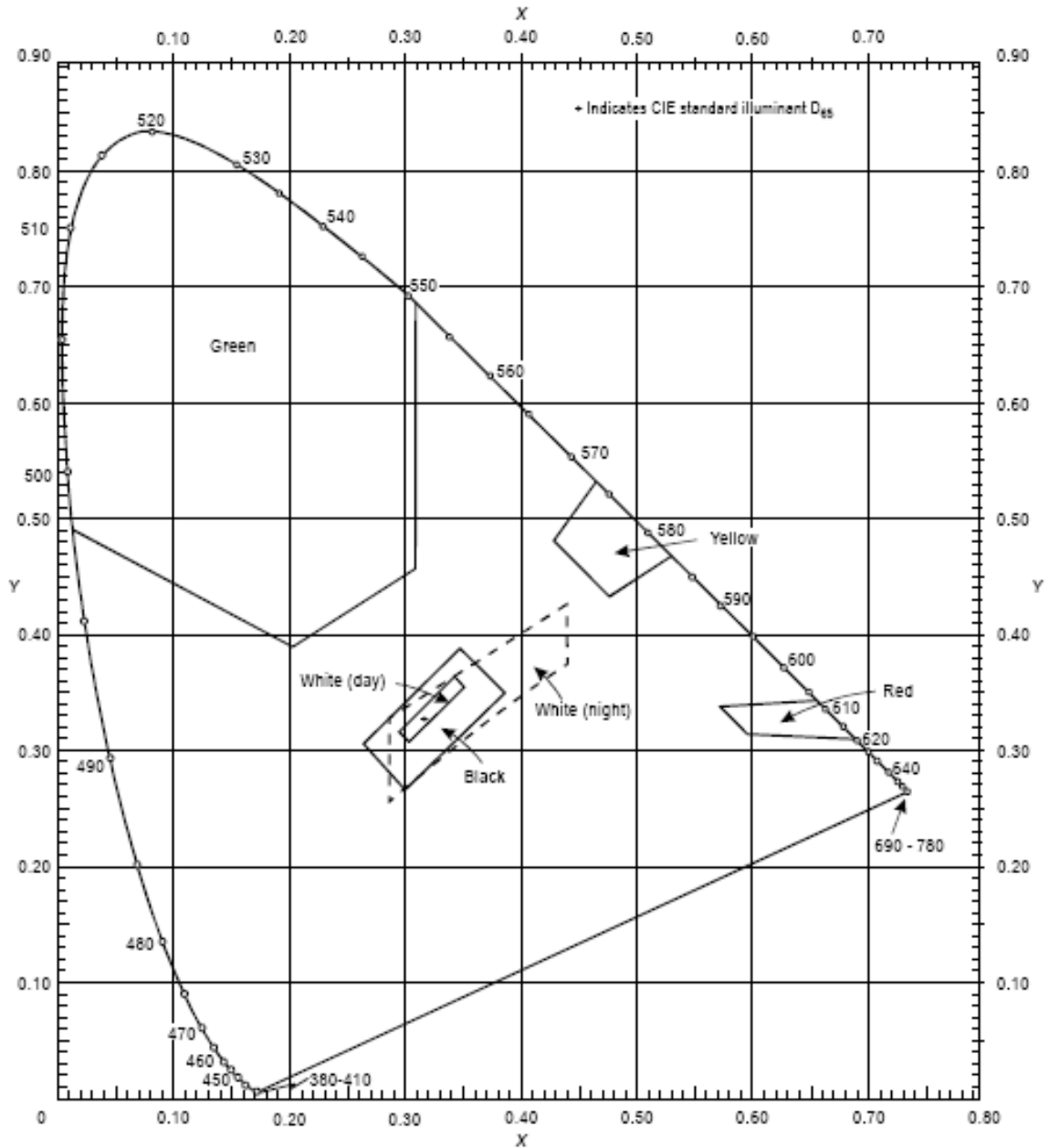
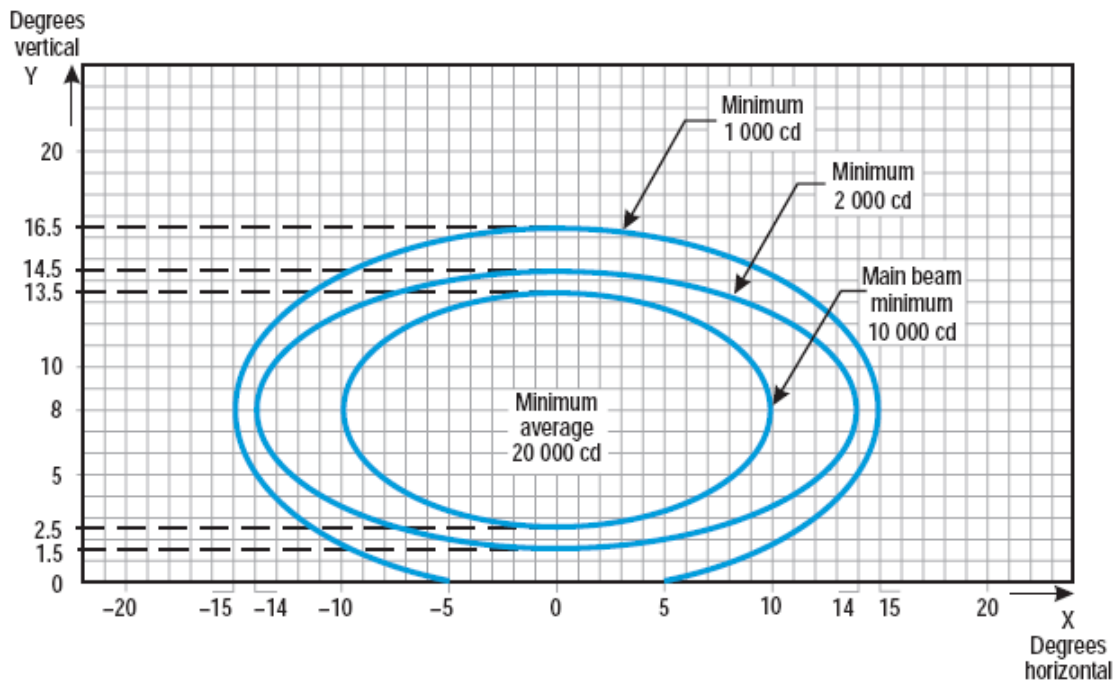

Figure A1-4. Colours of luminescent or transilluminated (internally illuminated) signs and panels

Appendix 2 Aeronautical ground light characteristics



Notes:

1. Curves calculated on formula

$$\frac{x^2}{a^2} + \frac{y^2}{b^2} = 1$$

a	10	14	15
b	5.5	6.5	8.5

2. Vertical setting angles of the lights shall be such that the following vertical coverage of the main beam will be met:

distance from threshold	vertical main beam coverage
threshold to 315 m	0° — 11°
316 m to 475 m	0.5° — 11.5°
476 m to 640 m	1.5° — 12.5°
641 m and beyond	2.5° — 13.5° (as illustrated above)

3. Lights in crossbars beyond 22.5 m from the centre line shall be toed-in 2 degrees. All other lights shall be aligned parallel to the centre line of the runway.
4. See collective notes for Figures A2-1 to A2-11.

Figure A2-1. Isocandela diagram for approach centre line light and crossbars (white light)

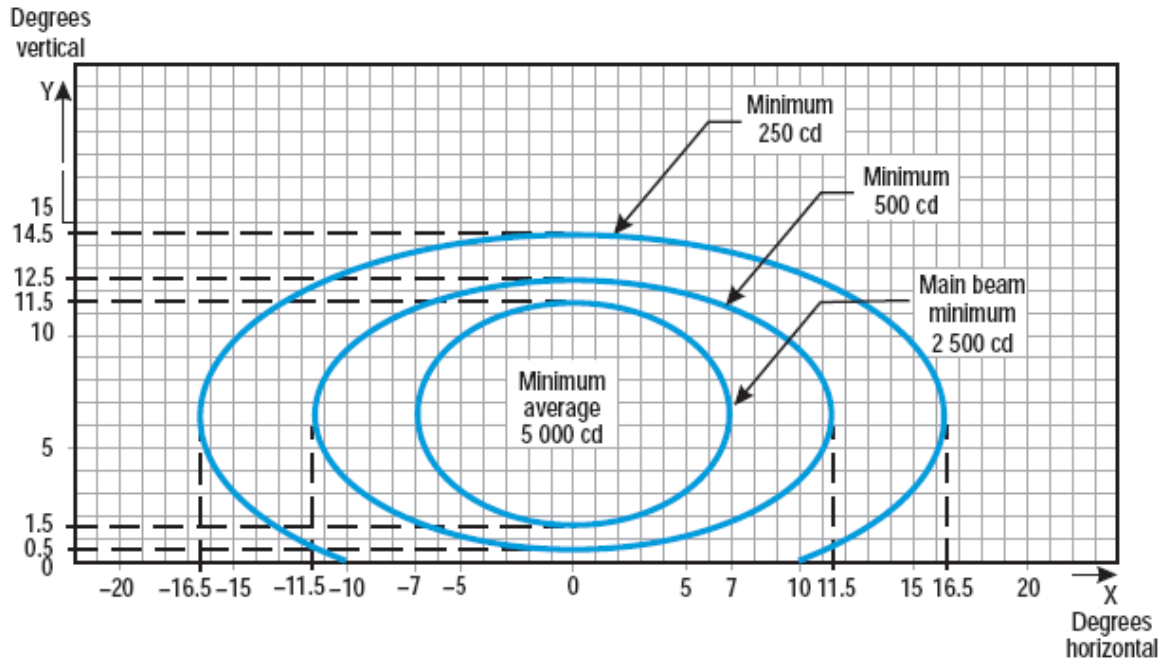

Notes:

1. Curves calculated on formula

$$\frac{x^2}{a^2} + \frac{y^2}{b^2} = 1$$

a	7.0	11.5	16.5
b	5.0	6.0	8.0

2. Toe-in 2 degrees
3. Vertical setting angles of the lights shall be such that the following vertical coverage of the main beam will be met:

distance from threshold	vertical main beam coverage
threshold to 115 m	0.5° — 10.5°
116 m to 215 m	1° — 11°
216 m and beyond	1.5° — 11.5° (as illustrated above)

4. See collective notes for Figures A2-1 to A2-11.

Figure A2-2. Isocandela diagram for approach side row light (red light)

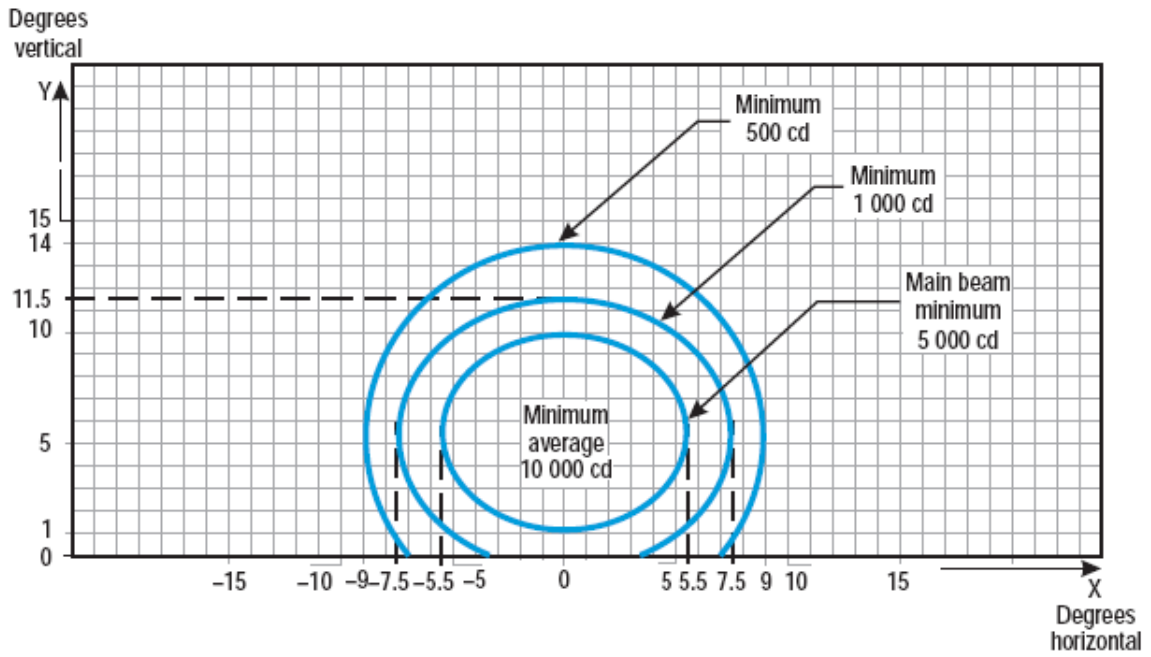

Notes:

1. Curves calculated on formula

$$\frac{x^2}{a^2} + \frac{y^2}{b^2} = 1$$

a	5.5	7.5	9.0
b	4.5	6.0	8.5

2. Toe-in 3.5 degrees
3. See collective notes for Figures A2-1 to A2-11.

Figure A2-3. Isocandela diagram for threshold light (green light)

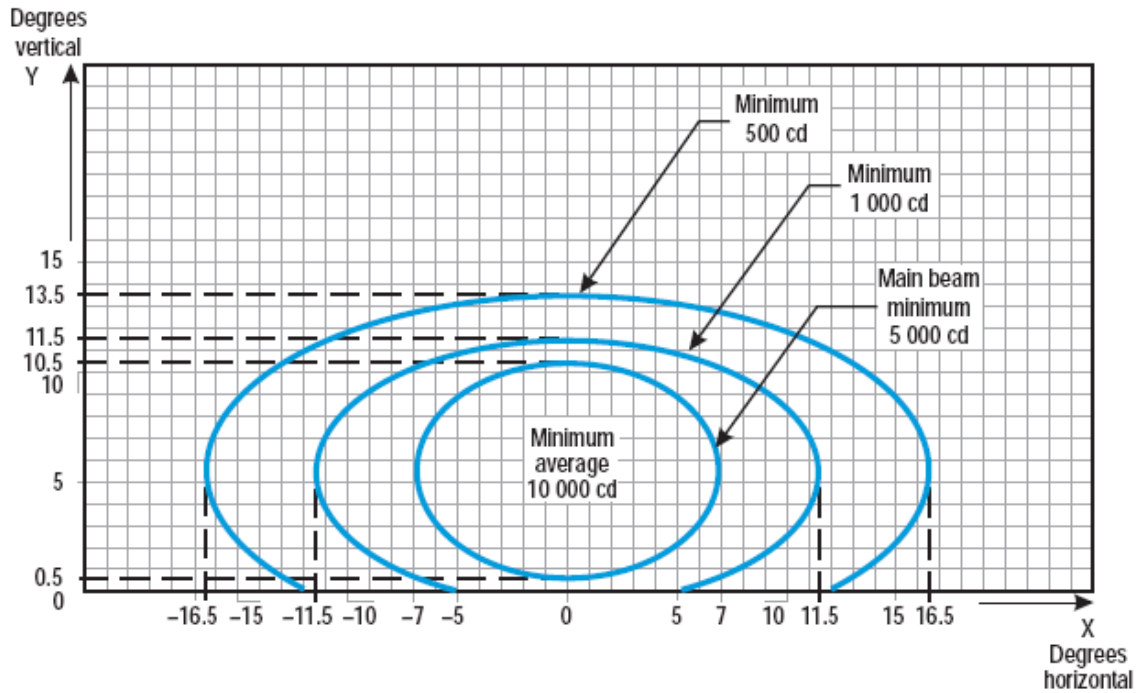

Notes:

1. Curves calculated on formula $\frac{x^2}{a^2} + \frac{y^2}{b^2} = 1$
2. Toe-in 2 degrees
3. See collective notes for Figures A2-1 to A2-11.

a	7.0	11.5	16.5
b	5.0	6.0	8.0

Figure A2-4. Isocandela diagram for threshold wing bar light (green light)

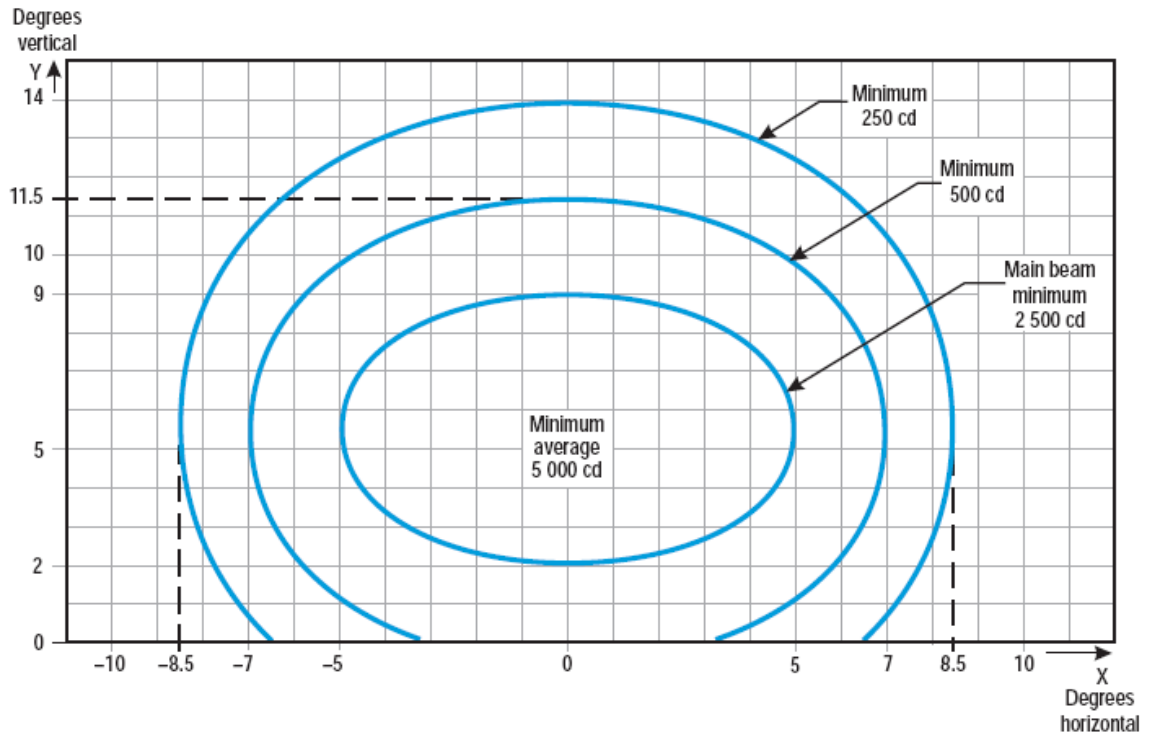

Notes:

1. Curves calculated on formula

$$\frac{x^2}{a^2} + \frac{y^2}{b^2} = 1$$

a	5.0	7.0	8.5
b	3.5	6.0	8.5

2. Toe-in 4 degrees
3. See collective notes for Figures A2-1 to A2-11.

Figure A2-5. Isocandela diagram for touchdown zone light (white light)

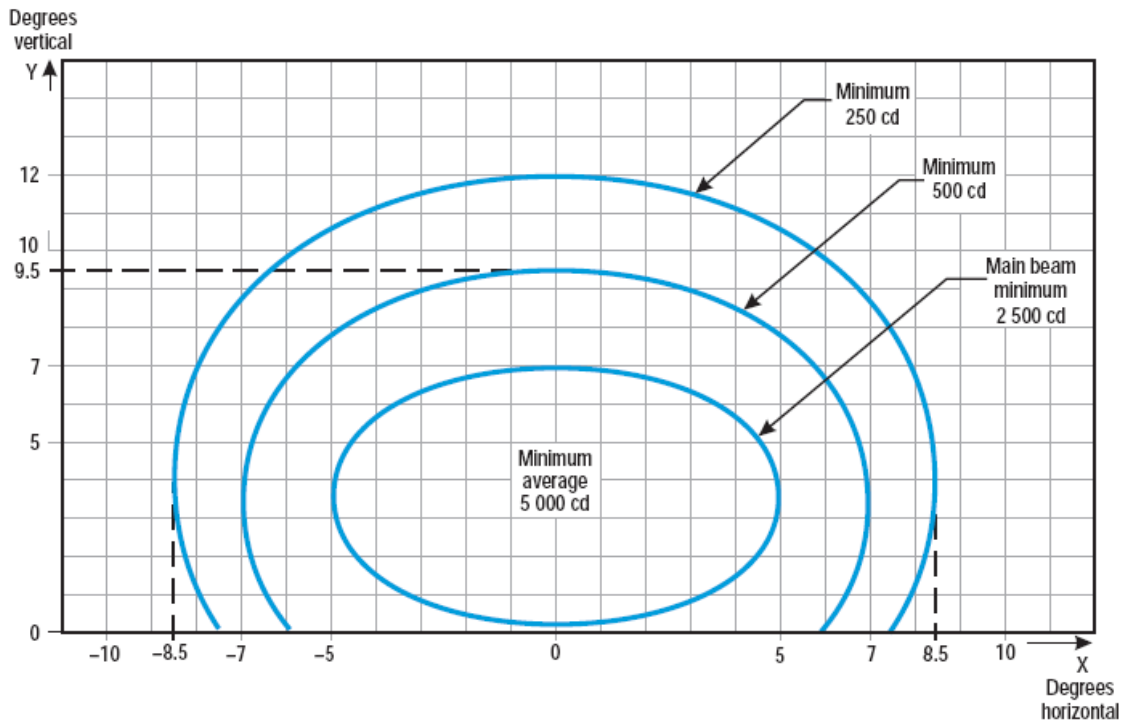

Notes:

1. Curves calculated on formula

$$\frac{x^2}{a^2} + \frac{y^2}{b^2} = 1$$

a	5.0	7.0	8.5
b	3.5	6.0	8.5

2. For red light, multiply values by 0.15.
3. For yellow light, multiply values by 0.40.
4. See collective notes for Figures A2-1 to A2-11.

Figure A2-6. Isocandela diagram for runway centre line light with 30 m longitudinal spacing (white light) and rapid exit taxiway indicator light (yellow light)

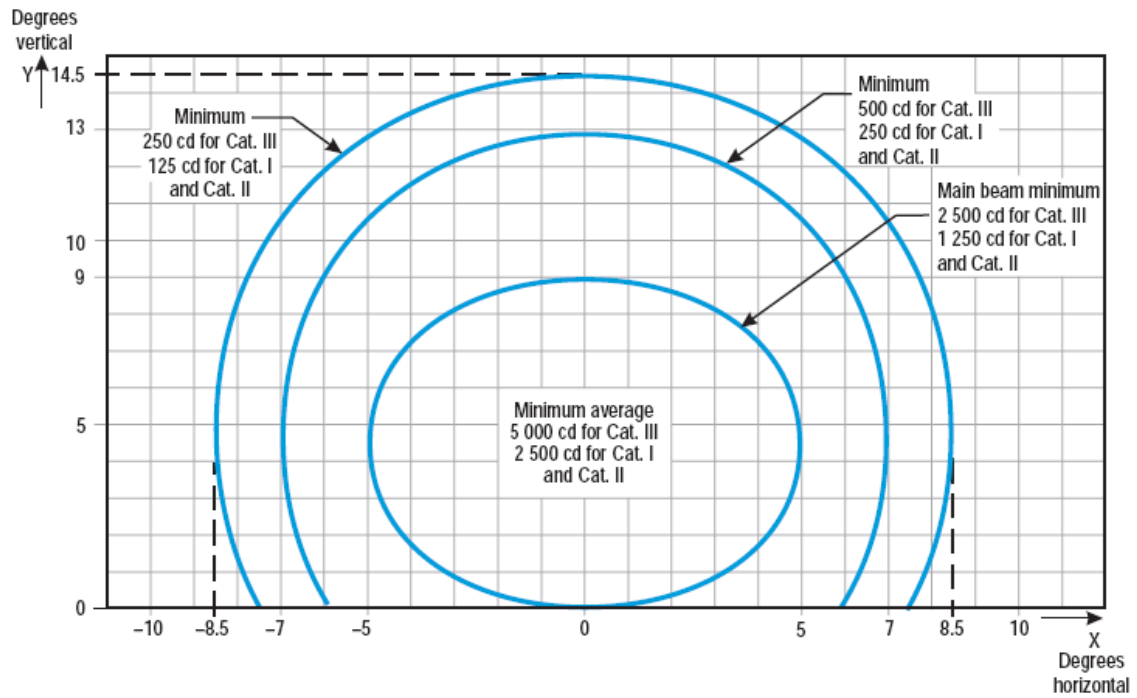

Notes:

1. Curves calculated on formula $\frac{x^2}{a^2} + \frac{y^2}{b^2} = 1$
2. For red light, multiply values by 0.15.
3. For yellow light, multiply values by 0.40.
4. See collective notes for Figures A2-1 to A2-11.

a	5.0	7.0	8.5
b	4.5	8.5	10

Figure A2-7. Isocandela diagram for runway centre line light with 15 m longitudinal spacing (white light) and rapid exit taxiway indicator light (yellow light)

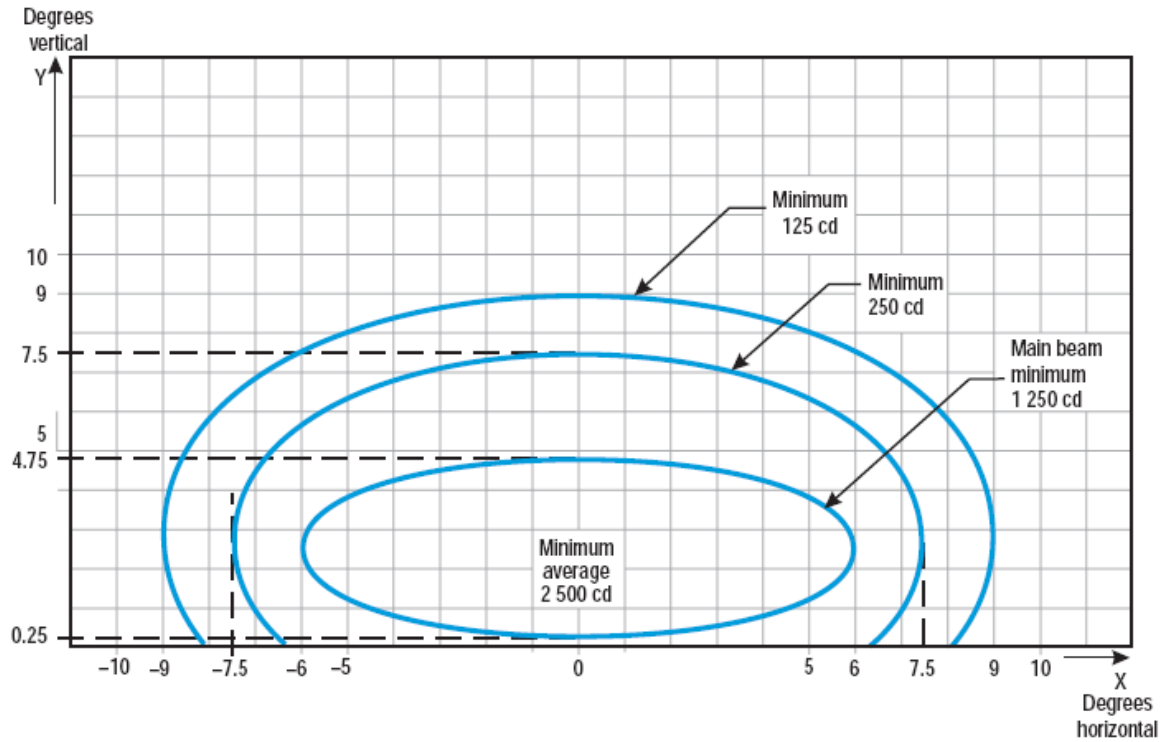

Notes:

1. Curves calculated on formula $\frac{x^2}{a^2} + \frac{y^2}{b^2} = 1$

a	6.0	7.5	9.0
b	2.25	5.0	6.5

2. See collective notes for Figures A2-1 to A2-11.

Figure A2-8. Isocandela diagram for runway end light (red light)

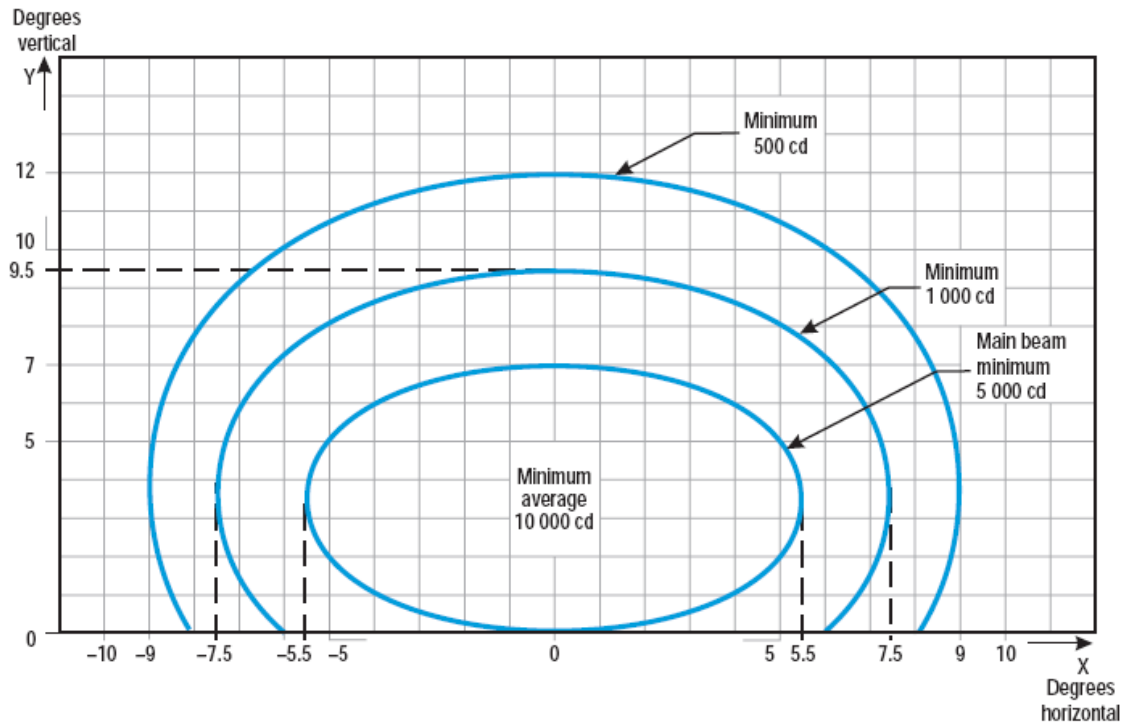

Notes:

1. Curves calculated on formula

$$\frac{x^2}{a^2} + \frac{y^2}{b^2} = 1$$

a	5.5	7.5	9.0
b	3.5	6.0	8.5

2. Toe-in 3.5 degrees
3. For red light, multiply values by 0.15.
4. For yellow light, multiply values by 0.40.
5. See collective notes for Figures A2-1 to A2-11.

Figure A2-9. Isocandela diagram for runway edge light where width of runway is 45 m (white light)

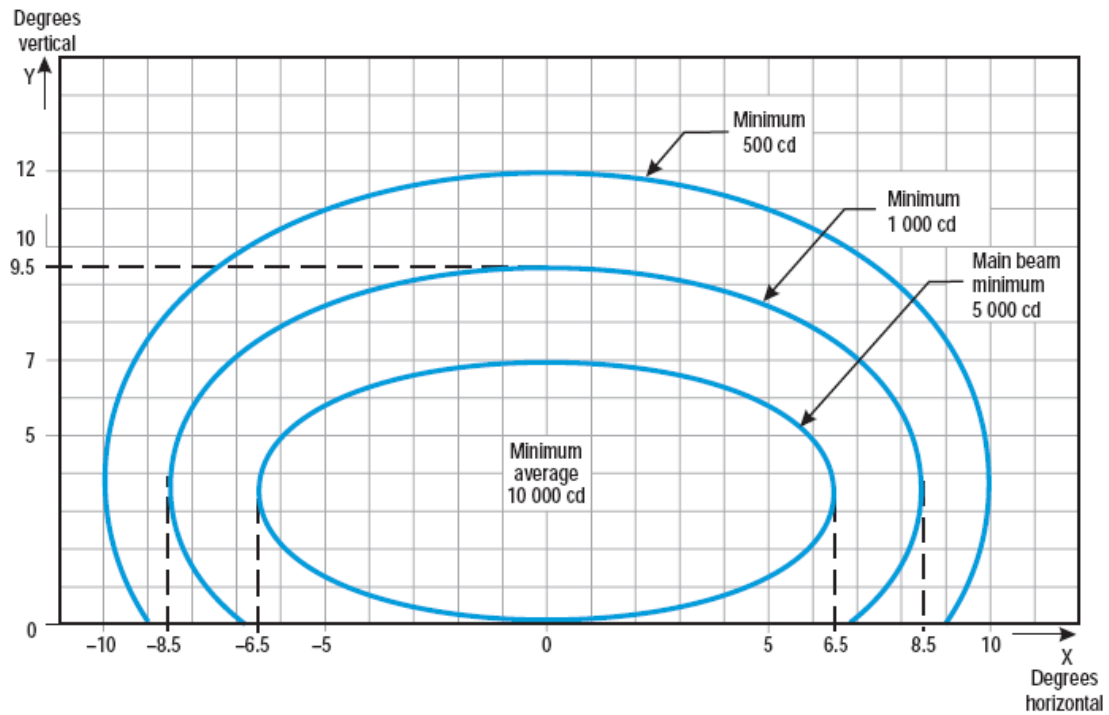

Notes:

1. Curves calculated on formula
2. Toe-in 4.5 degrees
3. For red light, multiply values by 0.15.
4. For yellow light, multiply values by 0.40.
5. See collective notes for Figures A2-1 to A2-11.

$$\frac{x^2}{a^2} + \frac{y^2}{b^2} = 1$$

a	6.5	8.5	10.0
b	3.5	6.0	8.5

Figure A2-10. Isocandela diagram for runway edge light where width of runway is 60 m (white light)

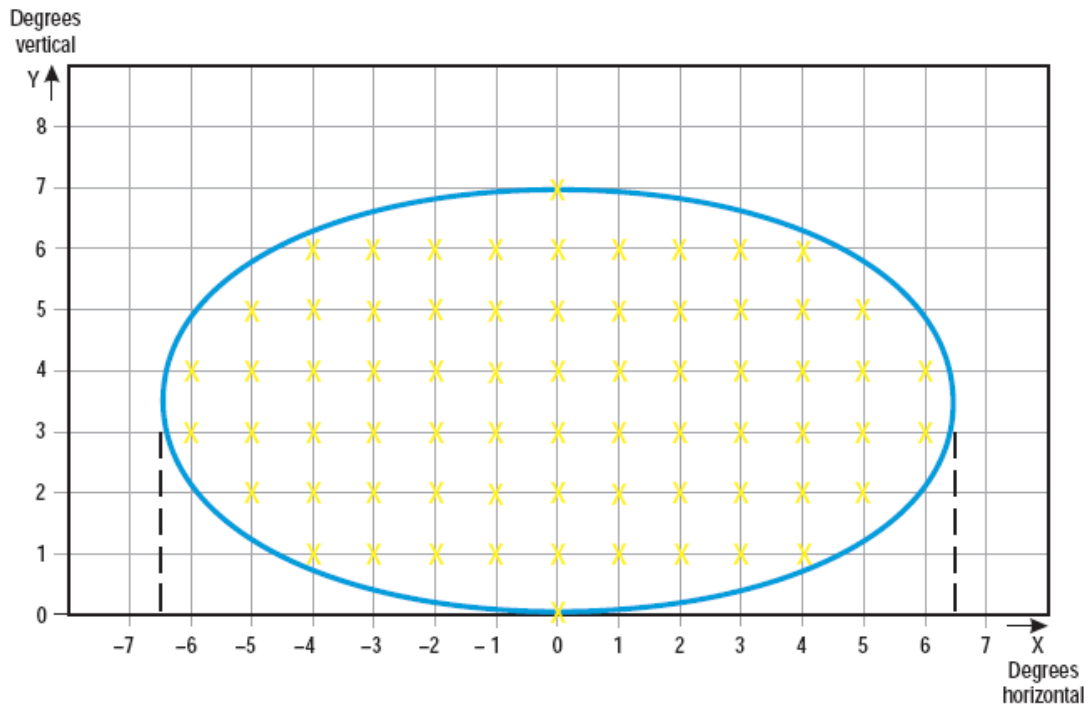

Figure A2-11. Grid points to be used for the calculation of average intensity of approach and runway lights

Collective notes to Figures A2-1 to A2-11

1. The ellipses in each figure are symmetrical about the common vertical and horizontal axes.
2. Figures A2-1 to A2-10 show the minimum allowable light intensities. The average intensity of the main beam is calculated by establishing grid points as shown in Figure A2-11 and using the intensity value measures at all grid points located within and on the perimeter of the ellipse representing the main beam. The average value is the arithmetic average of light intensities measured at all considered grid points.
3. No deviations are acceptable in the main beam pattern when the lighting fixture is properly aimed.
4. Average intensity ratio. The ratio between the average intensity within the ellipse defining the main beam of a typical new light and the average light intensity of the main beam of a new runway edge light shall be as follows:

Figure A2-1	Approach centre line and crossbars	1.5 to 2.0 (white light)
Figure A2-2	Approach side row	0.5 to 1.0 (red light)
Figure A2-3	Threshold	1.0 to 1.5 (green light)
Figure A2-4	Threshold wing bar	1.0 to 1.5 (green light)
Figure A2-5	Touchdown zone	0.5 to 1.0 (white light)
Figure A2-6	Runway centre line (longitudinal spacing 30 m)	0.5 to 1.0 (white light)
Figure A2-7	Runway centre line (longitudinal spacing 15 m)	0.5 to 1.0 for CAT III (white light)
		0.25 to 0.5 for CAT I, II (white light)
Figure A2-8	Runway end	0.25 to 0.5 (red light)
Figure A2-9	Runway edge (45 m runway width)	1.0 (white light)
Figure A2-10	Runway edge (60 m runway width)	1.0 (white light)

5. The beam coverages in the figures provide the necessary guidance for approaches down to an RVR of the order of 150 m and take-offs down to an RVR of the order of 100 m.

6. Horizontal angles are measured with respect to the vertical plane through the runway centre line. For lights other than centre line lights, the direction towards the runway centre line is considered positive. Vertical angles are measured with respect to the horizontal plane.

7. Where, for approach centre line lights and crossbars and for approach side row lights, inset lights are used in lieu of elevated lights, e.g. on a runway with a displaced threshold, the intensity requirements can be met by installing two or three fittings (lower intensity) at each position.

8. The importance of adequate maintenance cannot be overemphasized. The average intensity should never fall to a value less than 50 per cent of the value shown in the figures, and it should be the aim of airport authorities to maintain a level of light output close to the specified minimum average intensity.

9. The light unit shall be installed so that the main beam is aligned within one-half degree of the specified requirement.

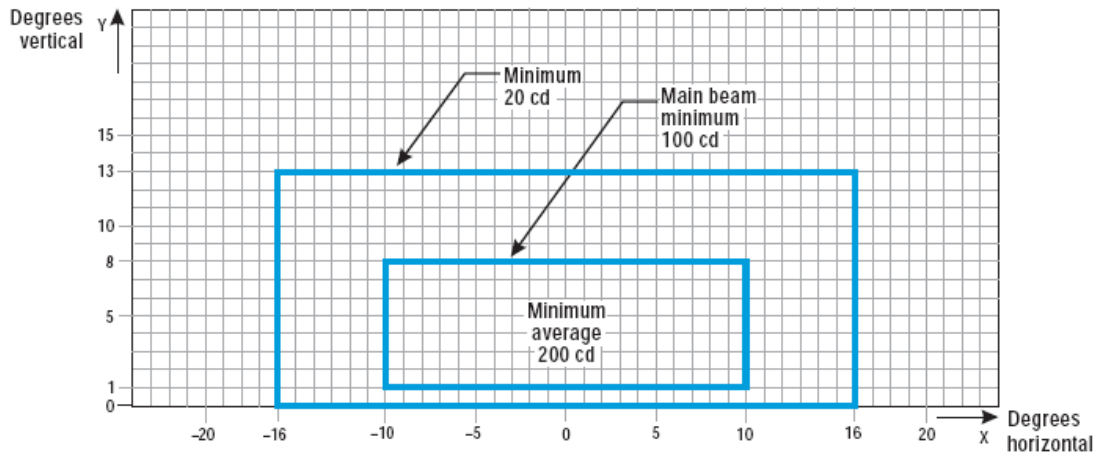

Notes:

1. These beam coverages allow for displacement of the cockpit from the centre line up to distances of the order of 12 m and are intended for use before and after curves.
2. See collective notes for Figures A2-12 to A2-21.
3. Increased intensities for enhanced rapid exit taxiway centre line lights as recommended in 5.3.16.9 are four times the respective intensities in the figure (i.e. 800 cd for minimum average main beam).

Figure A2-12. Isocandela diagram for taxiway centre line (15 m spacing) and stop bar lights in straight sections intended for use in runway visual range conditions of less than a value of 350 m where large offsets can occur and for low-intensity runway guard lights, Configuration B

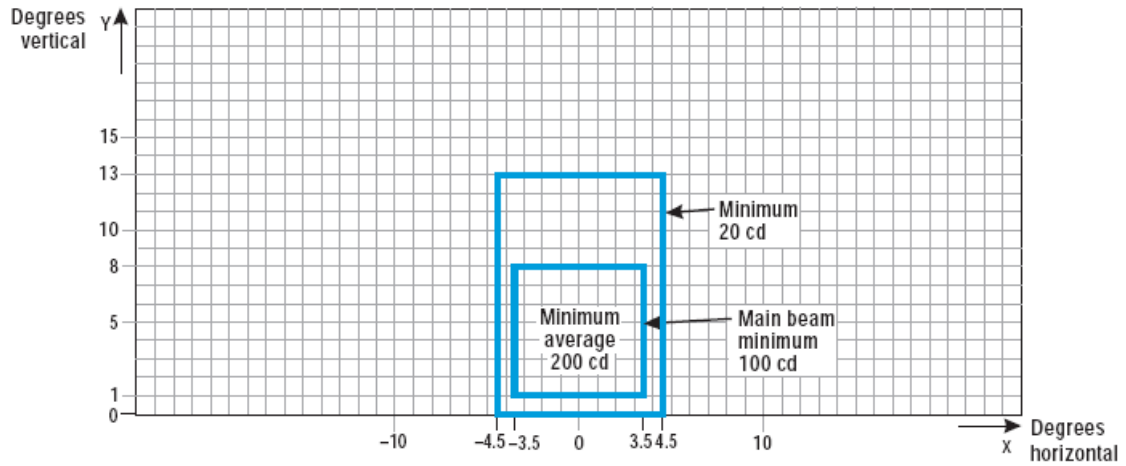

Notes:

1. These beam coverages are generally satisfactory and cater for a normal displacement of the cockpit from the centre line of approximately 3 m.
2. See collective notes for Figures A2-12 to A2-21.

Figure A2-13. Isocandela diagram for taxiway centre line (15 m spacing) and stop bar lights in straight sections intended for use in runway visual range conditions of less than a value of 350 m

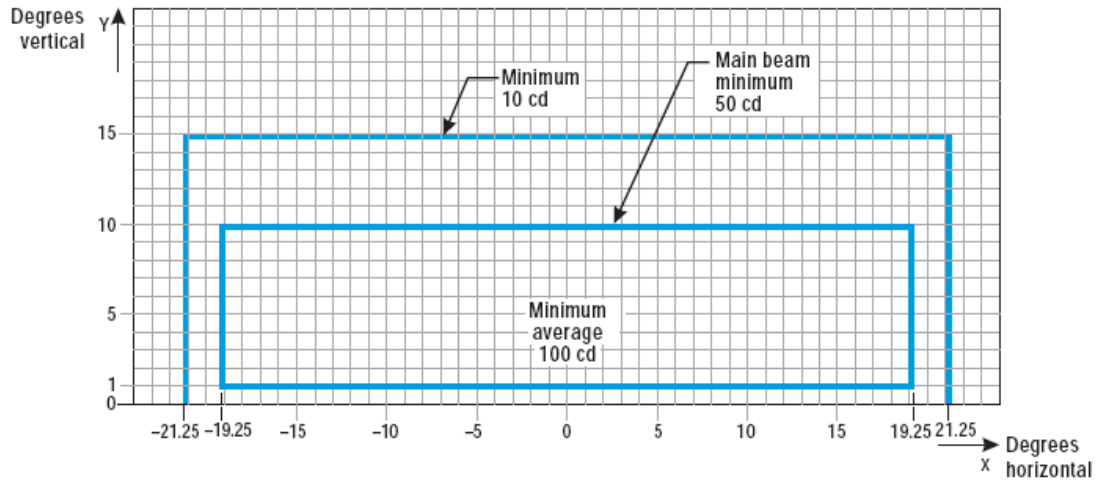

Notes:

1. Lights on curves to be toed-in 15.75 degrees with respect to the tangent of the curve.
2. See collective notes for Figures A2-12 to A2-21.

Figure A2-14. Isocandela diagram for taxiway centre line (7.5 m spacing) and stop bar lights in curved sections intended for use in runway visual range conditions of less than a value of 350 m

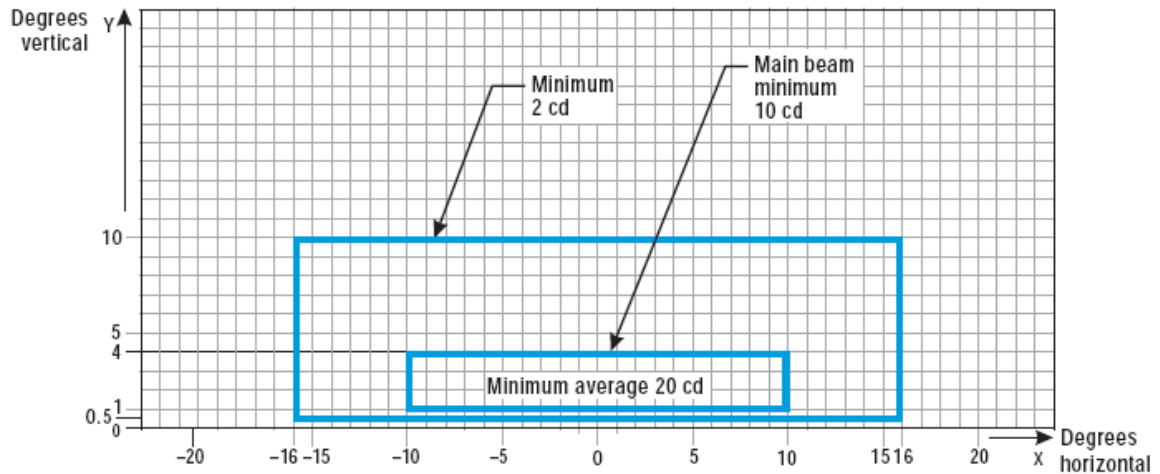

Notes:

1. At locations where high background luminance is usual and where deterioration of light output resulting from dust, snow and local contamination is a significant factor, the cd-values should be multiplied by 2.5.
2. Where omnidirectional lights are used they shall comply with the vertical beam requirements in this figure.
3. See collective notes for Figures A2-12 to A2-21.

Figure A2-15. Isocandela diagram for taxiway centre line (30 m, 60 m spacing) and stop bar lights in straight sections intended for use in runway visual range conditions of 350 m or greater

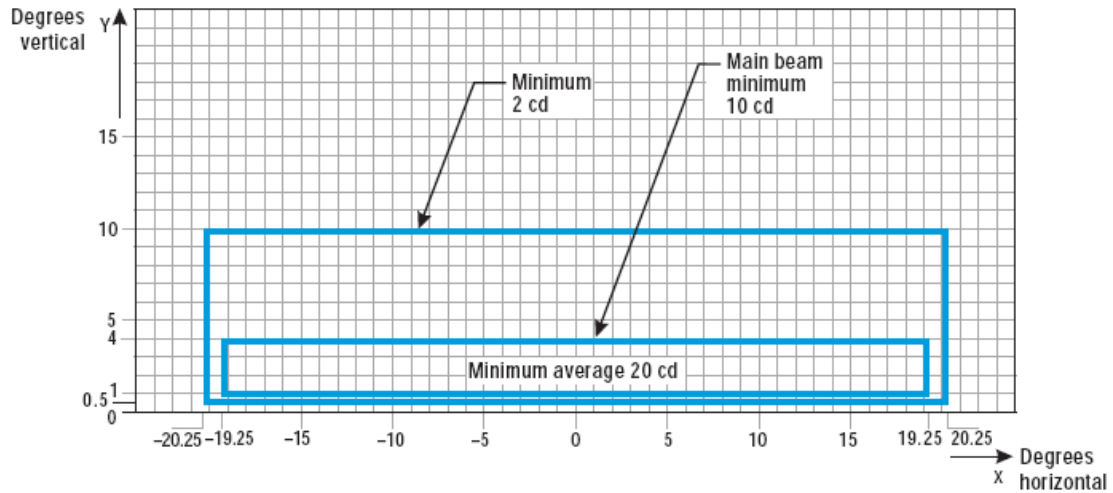

Notes:

1. Lights on curves to be toed-in 15.75 degrees with respect to the tangent of the curve.
2. At locations where high background luminance is usual and where deterioration of light output resulting from dust, snow and local contamination is a significant factor, the cd-values should be multiplied by 2.5.
3. These beam coverages allow for displacement of the cockpit from the centre line up to distances of the order of 12 m as could occur at the end of curves.
4. See collective notes for Figures A2-12 to A2-21.

Figure A2-16. Isocandela diagram for taxiway centre line (7.5 m, 15 m, 30 m spacing) and stop bar lights in curved sections intended for use in runway visual range conditions of 350 m or greater

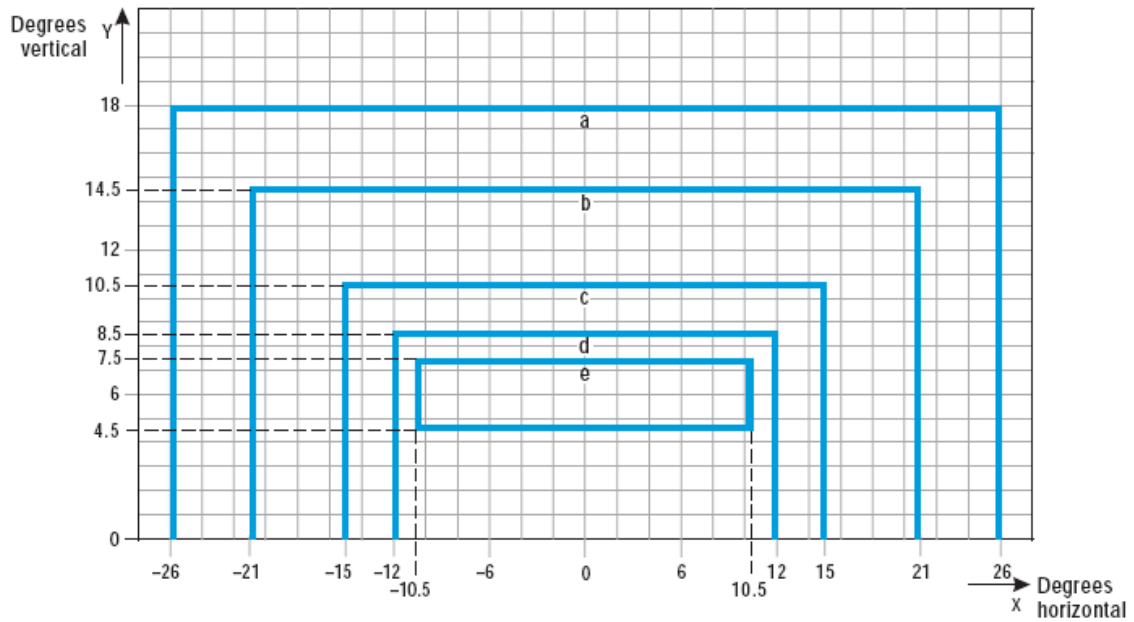

Curve	a	b	c	d	e
Intensity (cd)	8	20	100	450	1 800

Notes:

1. These beam coverages allow for displacement of the cockpit from the centre line up to distances of the order of 12 m and are intended for use before and after curves.
2. See collective notes for Figures A2-12 to A2-21.

Figure A2-17. Isocandela diagram for high-intensity taxiway centre line (15 m spacing) and stop bar lights in straight sections intended for use in an advanced surface movement guidance and control system where higher light intensities are required and where large offsets can occur

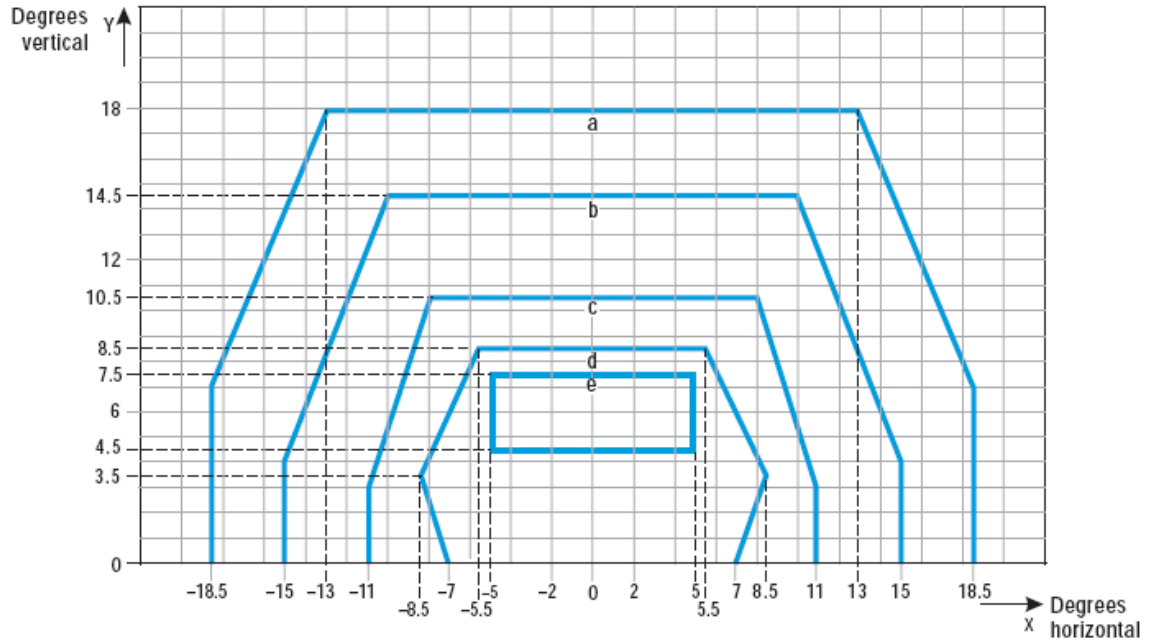

Curve	a	b	c	d	e
Intensity (cd)	8	20	100	450	1 800

Notes:

1. These beam coverages are generally satisfactory and cater for a normal displacement of the cockpit corresponding to the outer main gear wheel on the taxiway edge.
2. See collective notes for Figures A2-12 to A2-21.

Figure A2-18. Isocandela diagram for high-intensity taxiway centre line (15 m spacing) and stop bar lights in straight sections intended for use in an advanced surface movement guidance and control system where higher light intensities are required

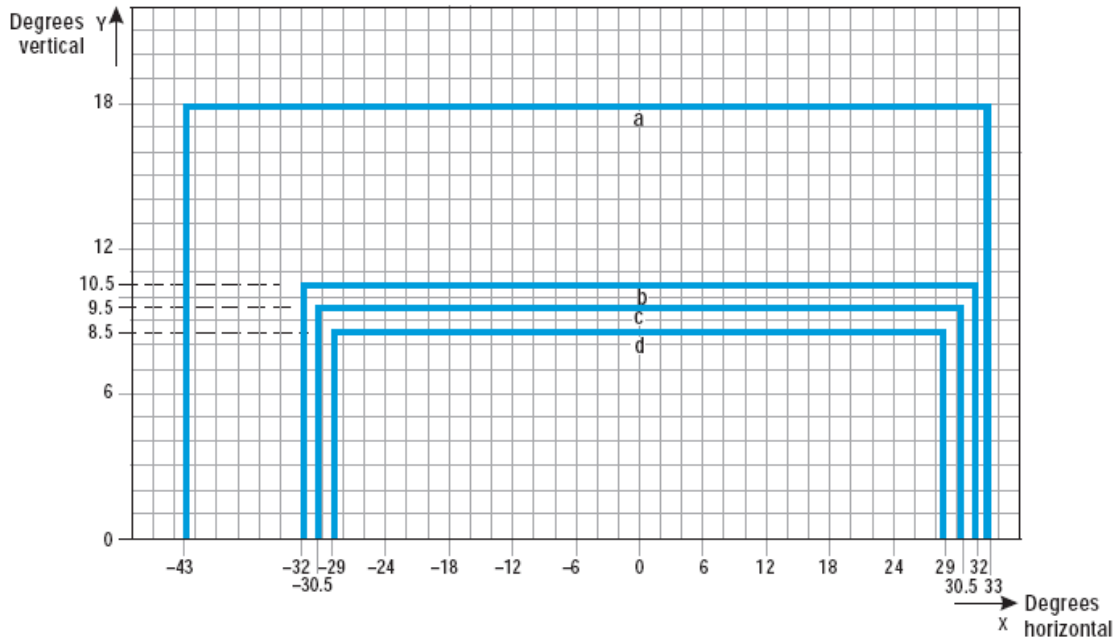

Curve	a	b	c	d
Intensity (cd)	8	100	200	400

Notes:

1. Lights on curves to be toed-in 17 degrees with respect to the tangent of the curve.
2. See collective notes for Figures A2-12 to A2-21.

Figure A2-19. Isocandela diagram for high-intensity taxiway centre line (7.5 m spacing) and stop bar lights in curved sections intended for use in an advanced surface movement guidance and control system where higher light intensities are required

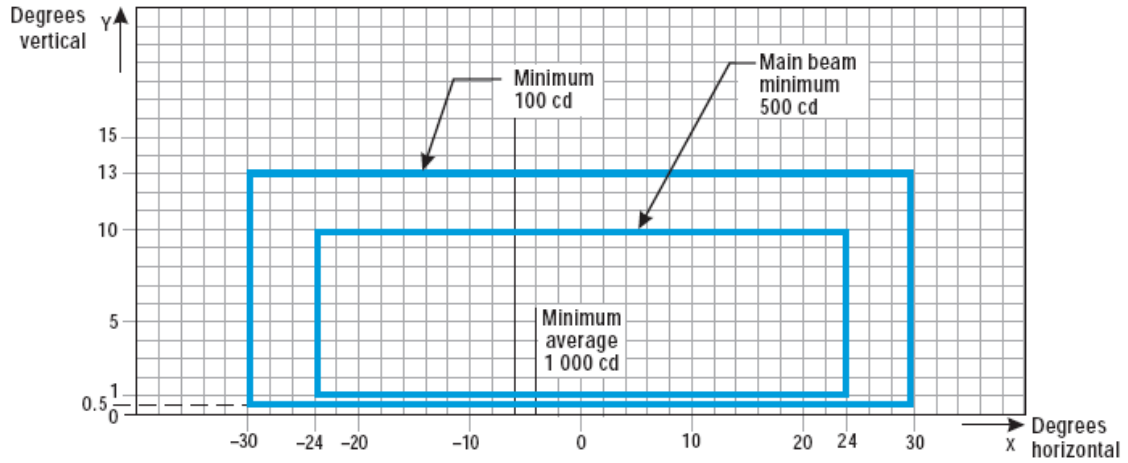

Notes:

1. Although the lights flash in normal operation, the light intensity is specified as if the lights were fixed for incandescent lamps.
2. See collective notes for Figures A2-12 to A2-21.

Figure A2-20. Isocandela diagram for high-intensity runway guard lights, Configuration B

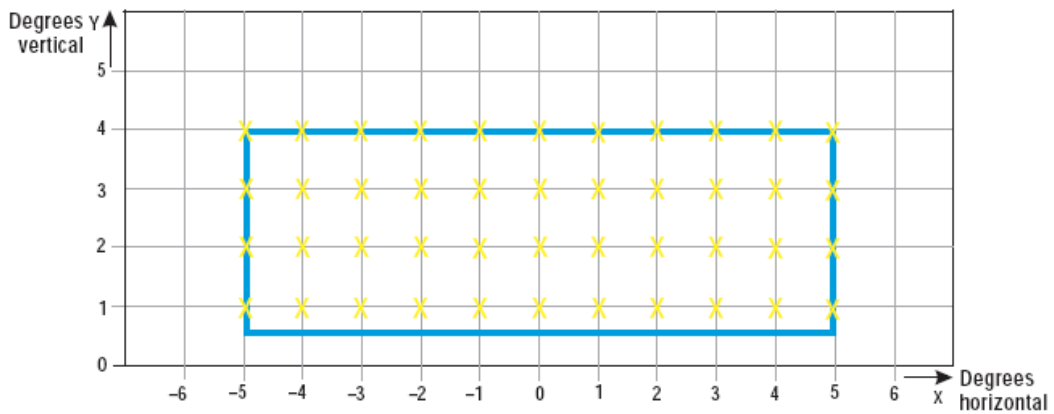

Figure A2-21. Grid points to be used for calculation of average intensity of taxiway centre line and stop bar lights

Collective notes to Figures A2-12 to A2-21

1. The intensities specified in Figures A2-12 to A2-20 are in green and yellow light for taxiway centre line lights, yellow light for runway guard lights and red light for stop bar lights.

2. Figures A2-12 to A2-20 show the minimum allowable light intensities. The average intensity of the main beam is calculated by establishing grid points as shown in Figure A2-21 and using the intensity values measured at all grid points located within and on the perimeter of the rectangle representing the main beam. The average value is the arithmetic average of the light intensities measured at all considered grid points.

3. No deviations are acceptable in the main beam or in the innermost beam, as applicable, when the lighting fixture is properly aimed.

4. Horizontal angles are measured with respect to the vertical plane through the taxiway centre line except on curves where they are measured with respect to the tangent to the curve.

5. Vertical angles are measured from the longitudinal slope of the taxiway surface.

6. The importance of adequate maintenance cannot be overemphasized. The intensity, either average where applicable or as specified on the corresponding isocandela curves, should never fall to a value less than 50 per cent of the value shown in the figures, and it should be the aim of airport authorities to maintain a level of light output close to the specified minimum average intensity.

7. The light unit shall be installed so that the main beam or the innermost beam, as applicable, is aligned within one-half degree of the specified requirement.

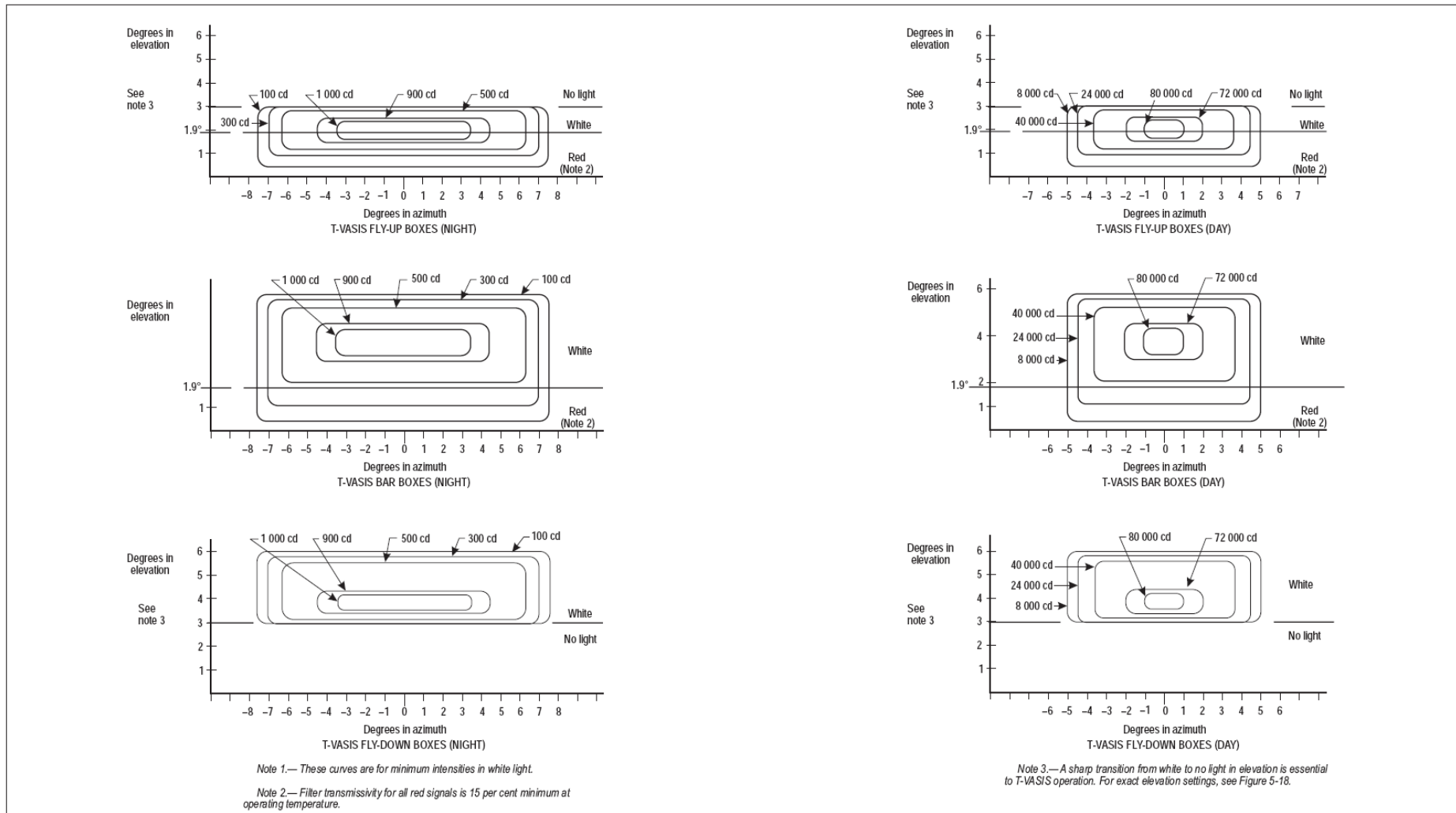
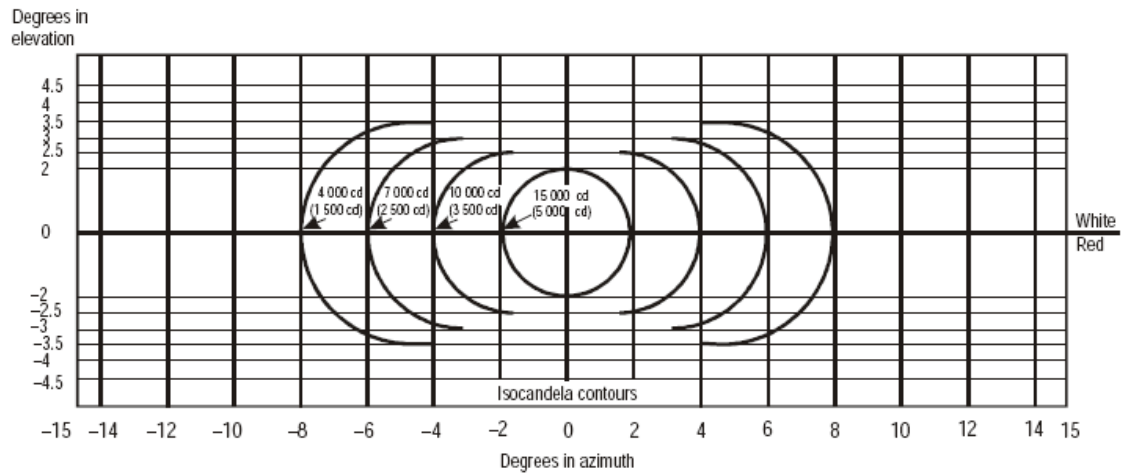

Figure A2-22. Light intensity distribution of T-VASIS and AT-VASIS



Notes:

1. These curves are for minimum intensities in red light.
2. The intensity value in the white sector of the beam is no less than 2 and may be as high as 6.5 times the corresponding intensity in the red sector.
3. The intensity values shown in brackets are for APAPI.

Figure A2-23. Light intensity distribution of PAPI and APAPI

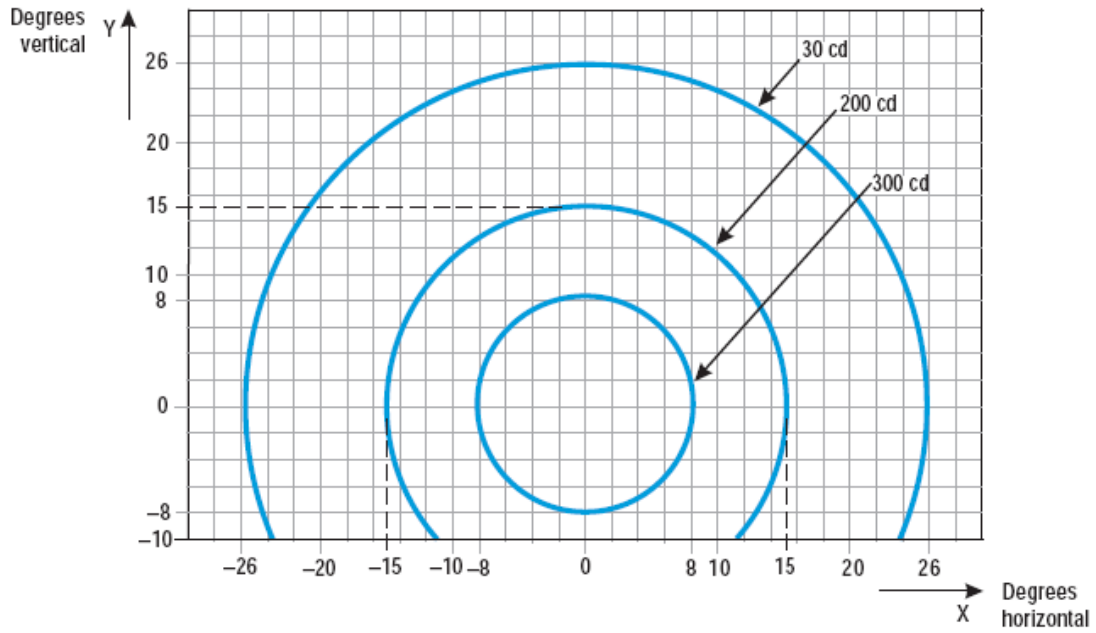

Notes:

1. Although the lights flash in normal operation, the light intensity is specified as if the lights were fixed for incandescent lamps.
2. The intensities specified are in yellow light.

Figure A2-24. Isocandela diagram for each light in low-intensity runway guard lights, Configuration A

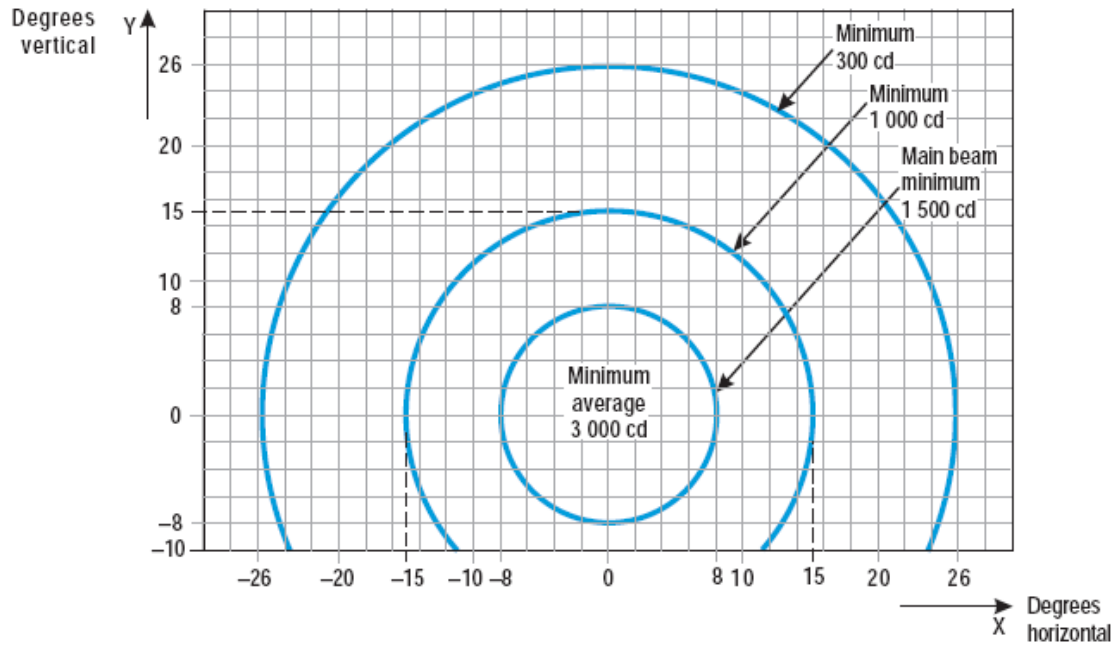

Notes:

1. Although the lights flash in normal operation, the light intensity is specified as if the lights were fixed for incandescent lamps.
2. The intensities specified are in yellow light.

Figure A2-25. Isocandela diagram for each light in high-intensity runway guard lights, Configuration A

Appendix 3 Mandatory instruction markings and information markings

Note 1: See section 5 paragraphs 5.2.107 to 5.2.121 for specifications on the application, location and characteristics of mandatory instruction markings and information markings.

Note 2: This appendix details the form and proportions of the letters, numbers and symbols of mandatory instruction markings and information markings on a 200 mm grid.

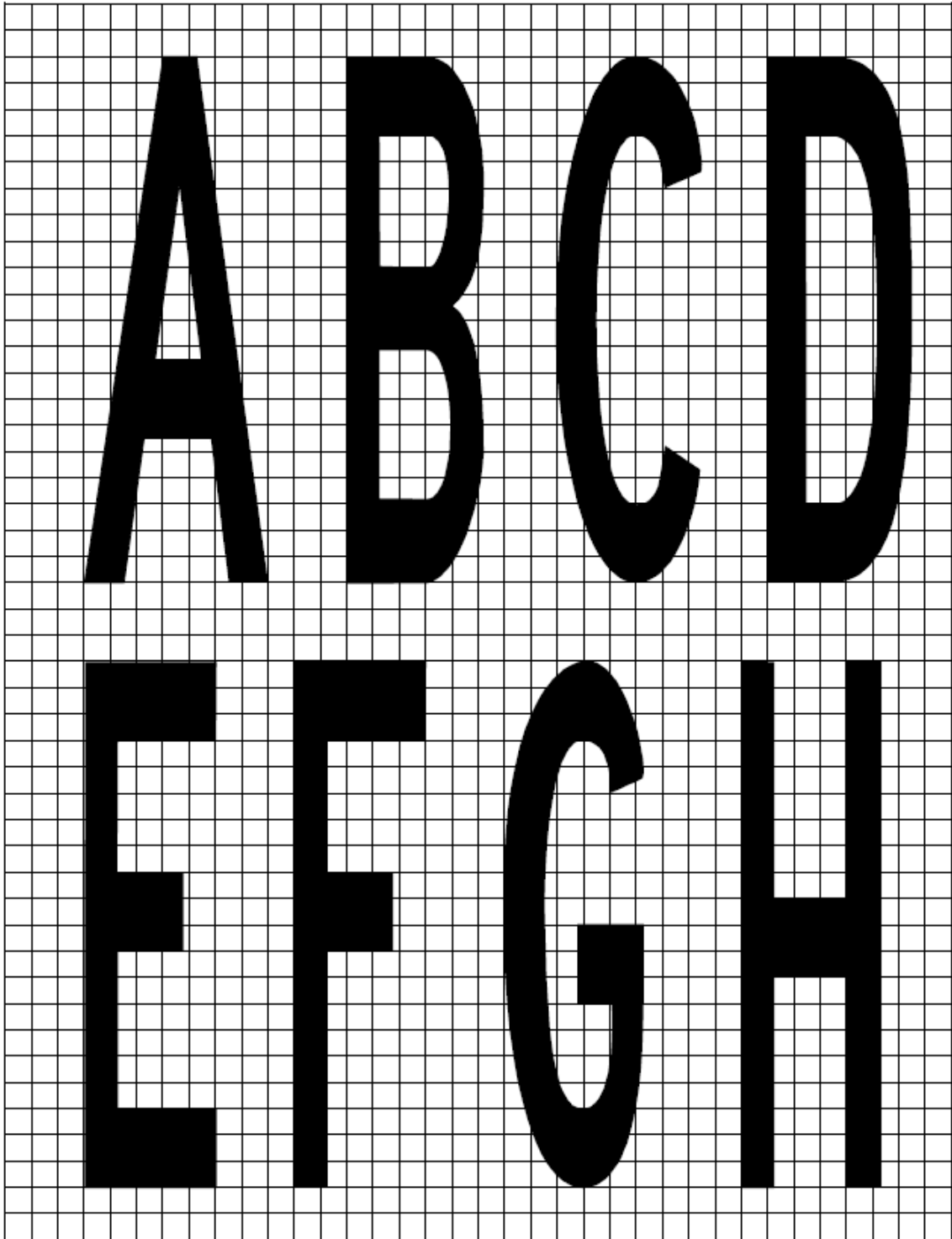

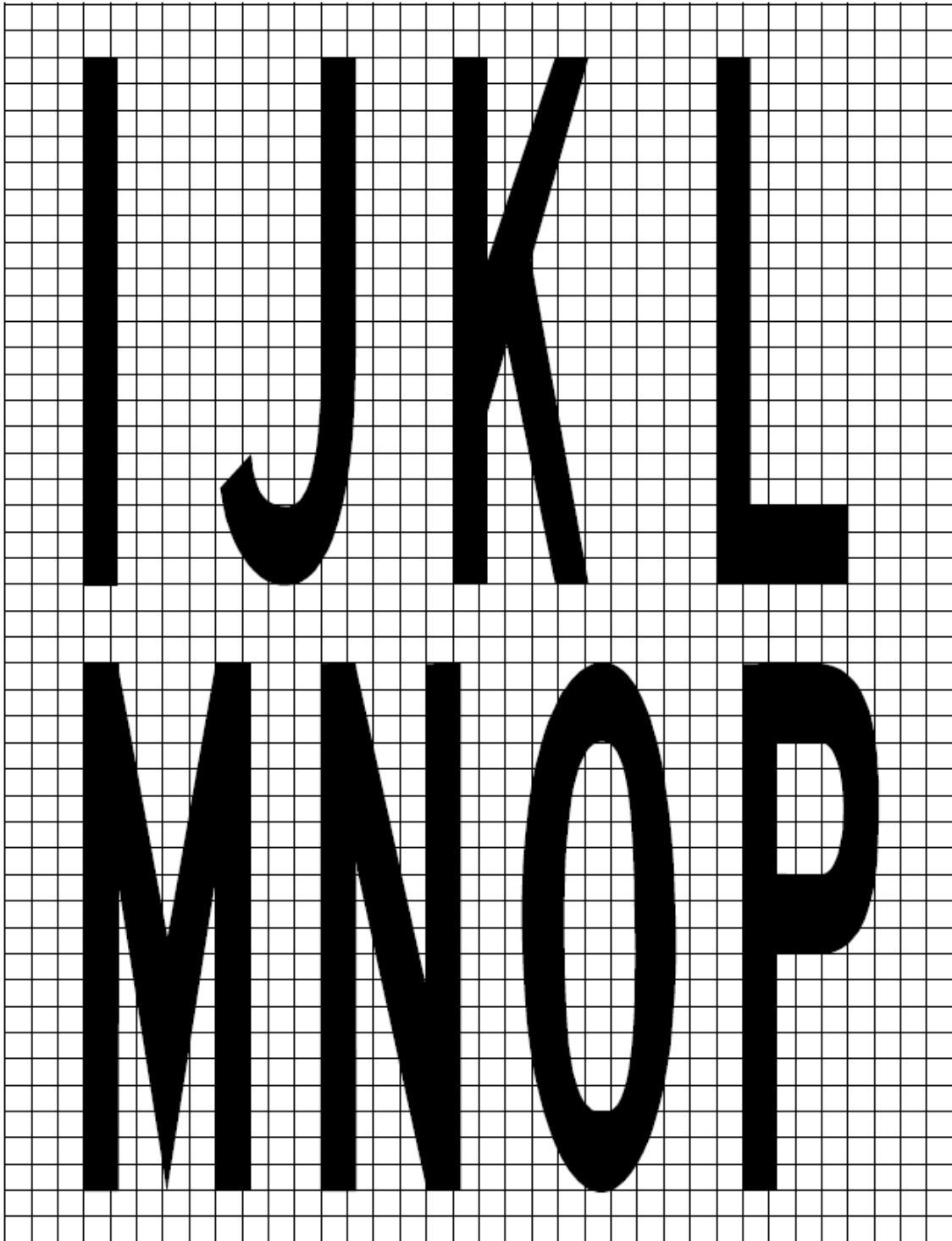

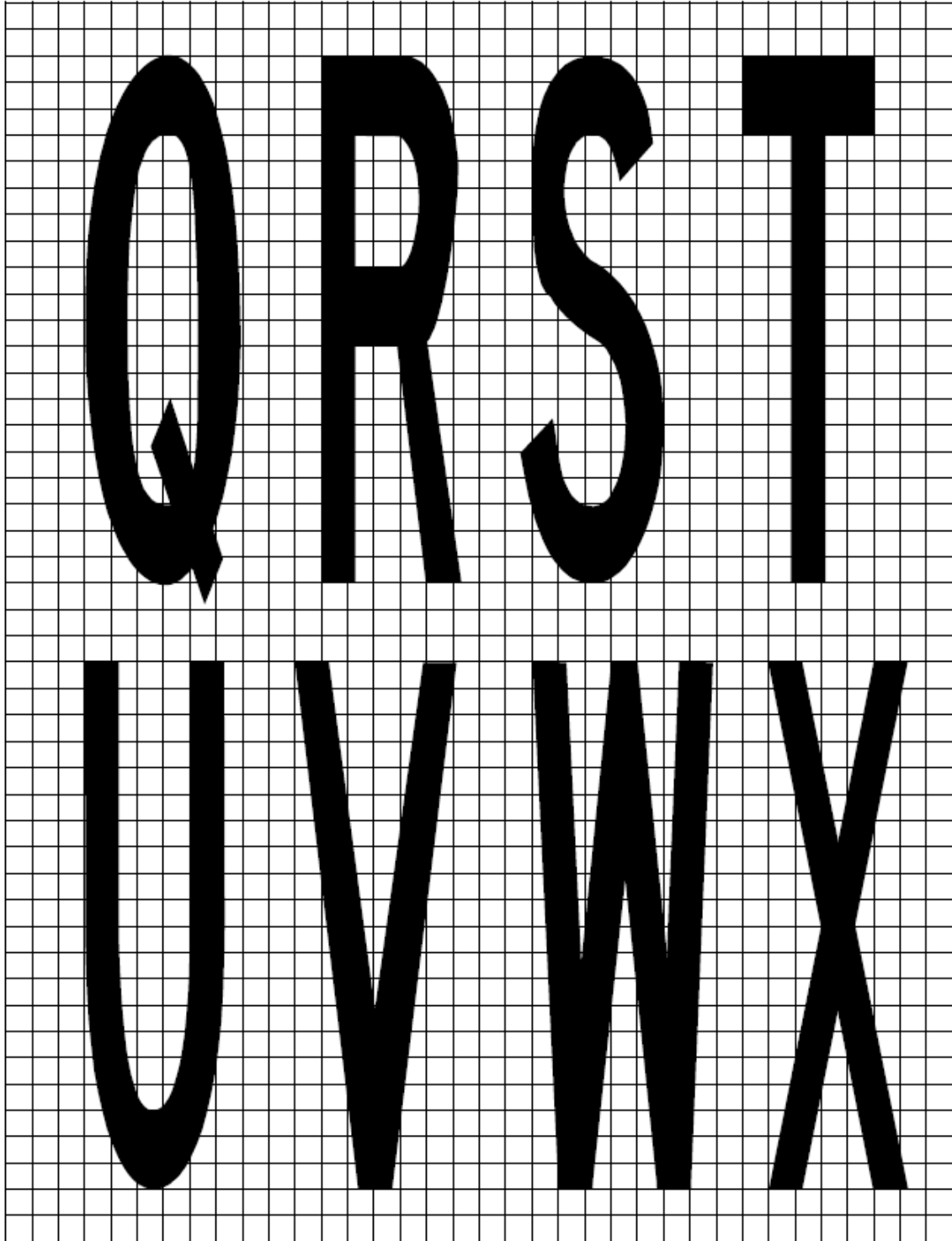

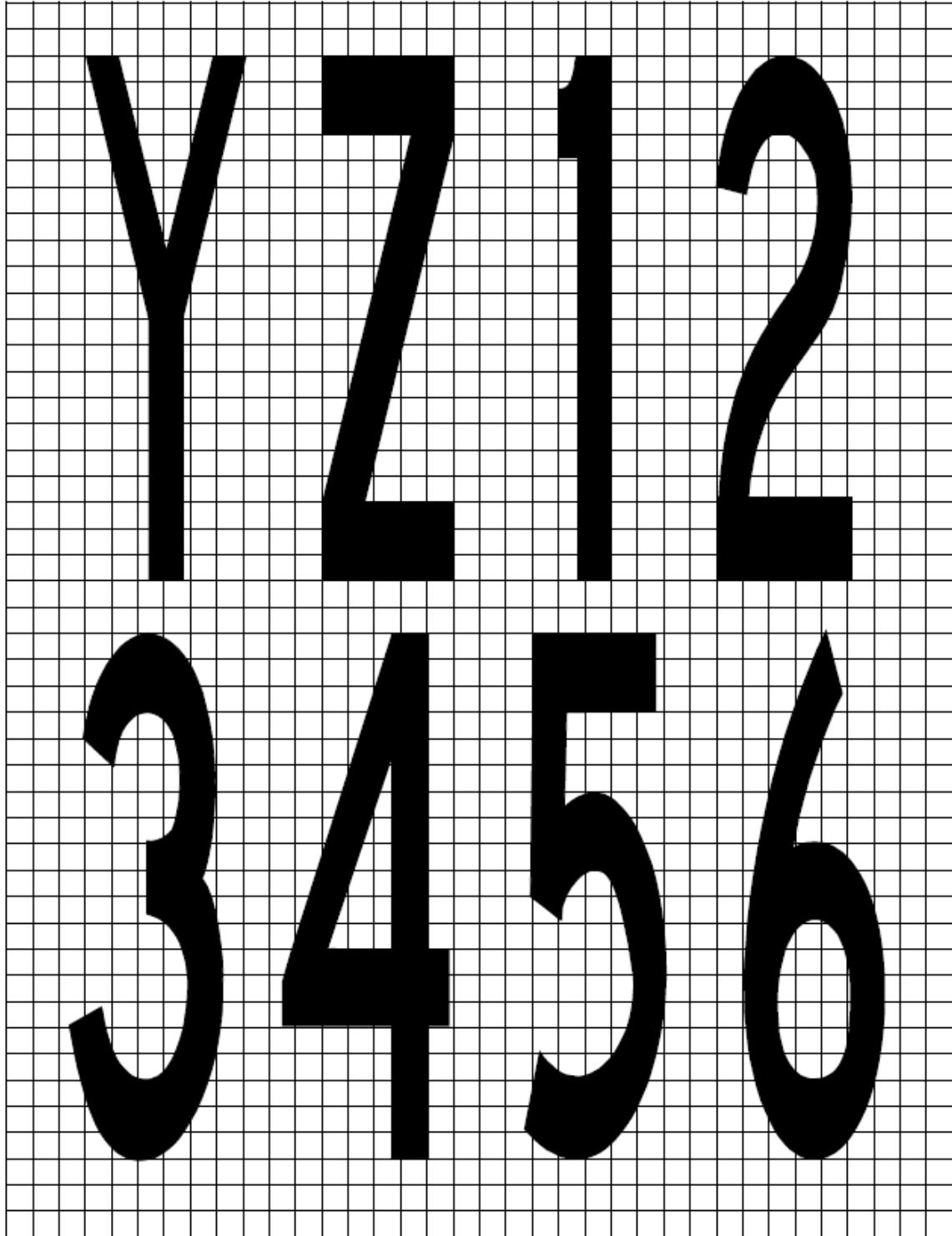

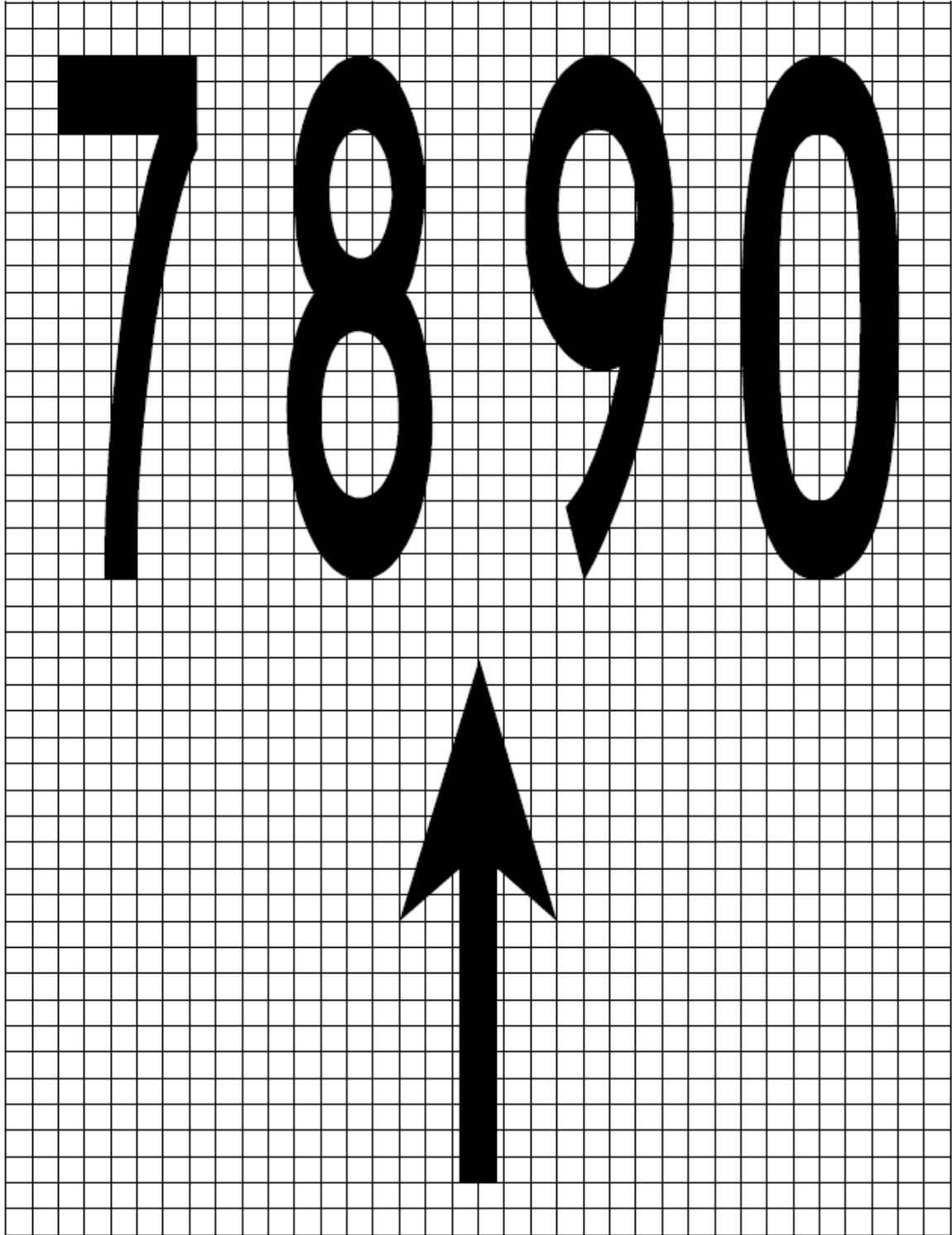

Appendix 4 Requirements concerning design of taxiing signs

Note: See section 5, subsection 5.4, for specifications on the application, location and characteristics of signs.

1. Inscription heights should conform to the following tabulation.

Runway code number	Minimum character height		
	Mandatory instruction sign	Information sign	
		Runway exit and runway vacated signs	Other signs
1 or 2	300 mm	300 mm	200 mm
3 or 4	400 mm	400 mm	300 mm

Note: Where a taxiway location sign is installed in conjunction with a runway designation sign (see paragraph 5.4.50), the character size should be that specified for mandatory instruction signs.

2. Arrow dimensions should be as follows:

Legend height	Stroke
200 mm	32 mm
300 mm	48 mm
400 mm	64 mm

3. Stroke width for single letter should be as follows:

Legend height	Stroke
200 mm	32 mm
300 mm	48 mm
400 mm	64 mm

4. Sign luminance should be as follows:

- (a) Where operations are conducted in runway visual range conditions less than a value of 800 m, average sign luminance should be at least:

Red	30 cd/m ²
Yellow	150 cd/m ²
White	300 cd/m ²

- (b) Where operations are conducted in accordance with paragraph 5.4.7, average sign luminance should be at least:

Red	10 cd/m ²
Yellow	50 cd/m ²
White	100 cd/m ²

Note: In runway visual range conditions less than a value of 400 m, there will be some degradation in the performance of signs.

5. The luminance ratio between red and white elements of a mandatory sign should be between 1:5 and 1:10.
6. The average luminance of the sign is calculated by establishing grid points as shown in Figure A4-1 and using the luminance values measured at all grid points located within the rectangle representing the sign.
7. The average value is the arithmetic average of the luminance values measured at all considered grid points.

Note: *Guidance on measuring the average luminance of a sign is contained in the Aerodrome Design Manual (ICAO Doc 9157), Part 4.*

8. The ratio between luminance values of adjacent grid points should not exceed 1.5:1. For areas on the sign face where the grid spacing is 7.5 cm, the ratio between luminance values of adjacent grid points should not exceed 1.25:1. The ratio between the maximum and minimum luminance value over the whole sign face should not exceed 5:1.
9. The forms of characters, i.e. letters, numbers, arrows and symbols, should conform to those shown in Figure A4-2. The width of characters and the space between individual characters should be determined as indicated in Table A4-1.
10. The face height of signs should be as follows:

Legend height	Face height (min)
200 mm	400 mm
300 mm	600 mm
400 mm	800 mm

11. The face width of signs should be determined using Figure A4-3 except that, where a mandatory instruction sign is provided on one side of a taxiway only, the face width should not be less than—
- 1.94 m where the code number is 3 or 4
 - 1.46 m where the code number is 1 or 2.

Note: *Additional guidance on determining the face width of a sign is contained in the Aerodrome Design Manual (ICAO Doc 9157), Part 4.*

12. Borders
- The black vertical delineator between adjacent direction signs should have a width of approximately 0.7 of the stroke width.
 - The yellow border on a stand-alone location sign should be approximately 0.5 stroke width.

13. The colours of signs should be in accordance with the appropriate specifications in ICAO Annex 14 Appendix 1.

Note: *Copies of Appendix 1 are available from the Aeronautical Services Unit of the CAA on request.*

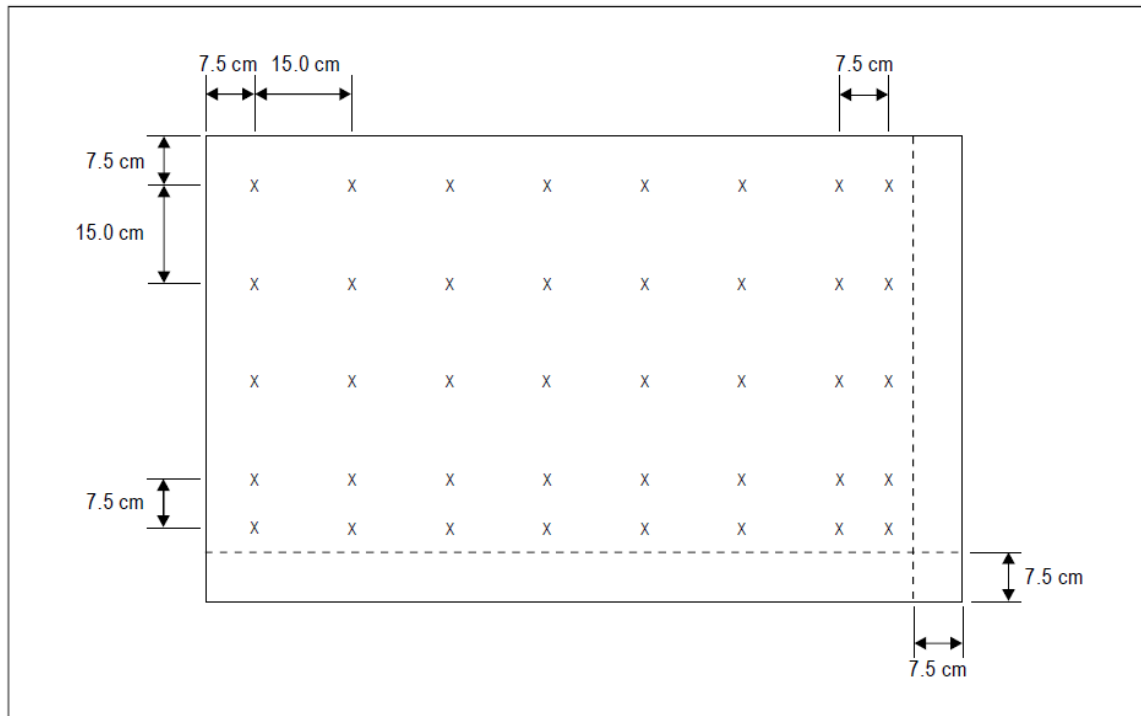

Figure A4-1. Grid points for calculating average luminance of a sign

Note 1: The average luminance of a sign is calculated by establishing grid points on a sign face showing typical inscriptions and a background of the appropriate colour (red for mandatory instruction signs and yellow for direction and destination signs) as follows.

- (a) Starting at the top left corner of the sign face, establish a reference grid point at 7.5 cm from the left edge and the top of the sign face.
- (b) Create a grid of 1.5 m spacing horizontally and vertically from the reference grid point. Grid points within 750 mm of the edge of the sign face should be excluded.
- (c) Where the last point in a row/column of grid points is located between 2.25 m and 1.5 m from the edge of the sign face (but not inclusive), an additional point should be added 750 mm from this point.
- (d) Where a grid point falls on the boundary of a character and the background, the grid point should be slightly shifted to be completely outside the character.

Note 2: Additional grid points may be required to ensure that each character includes at least five evenly spaced grid points.

Note 3: Where one unit includes two types of signs, a separate grid should be established for each type.

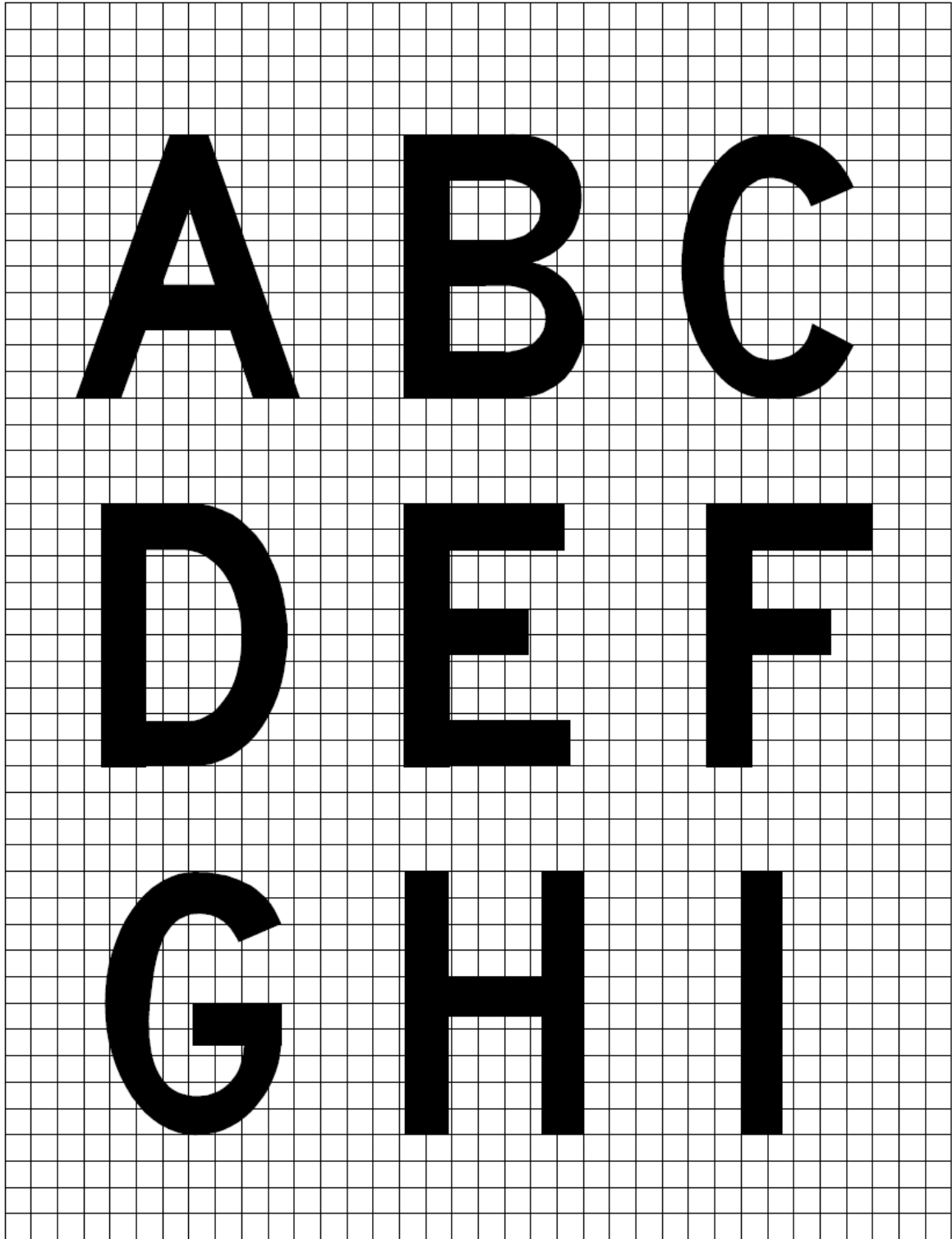

Figure A4-2. Forms of characters

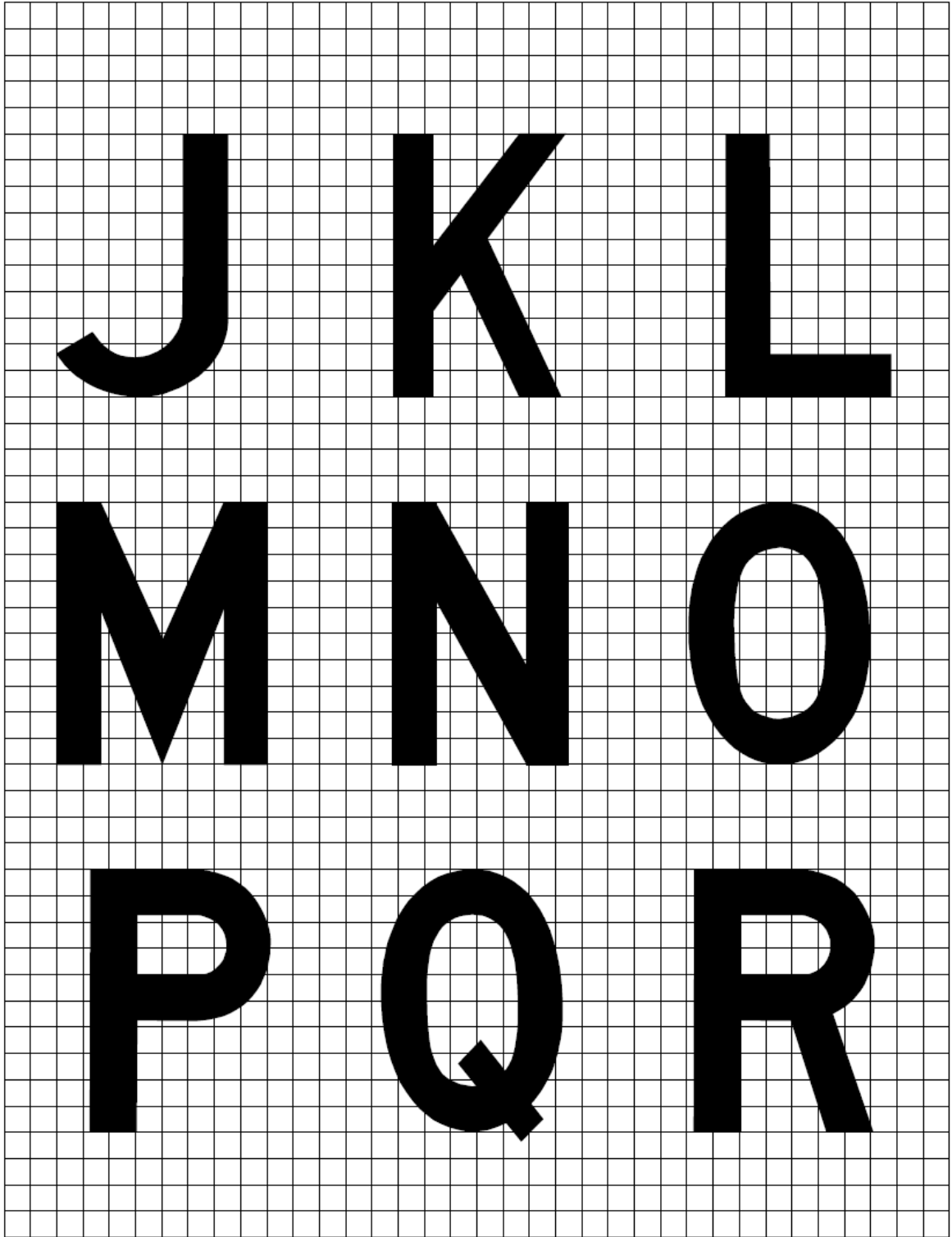

Figure A4-2. Forms of characters (cont.)

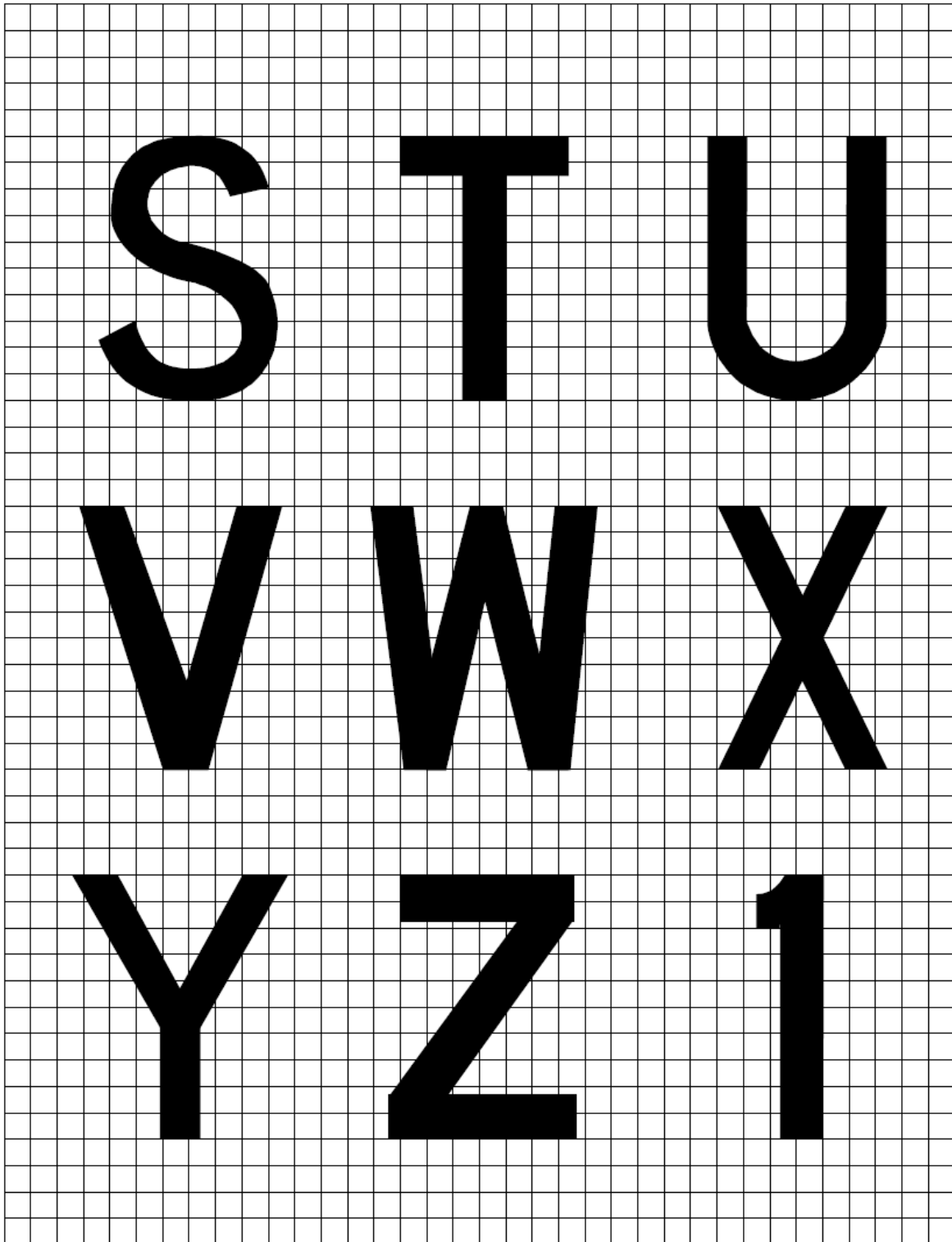

Figure A4-2. Forms of characters (cont.)

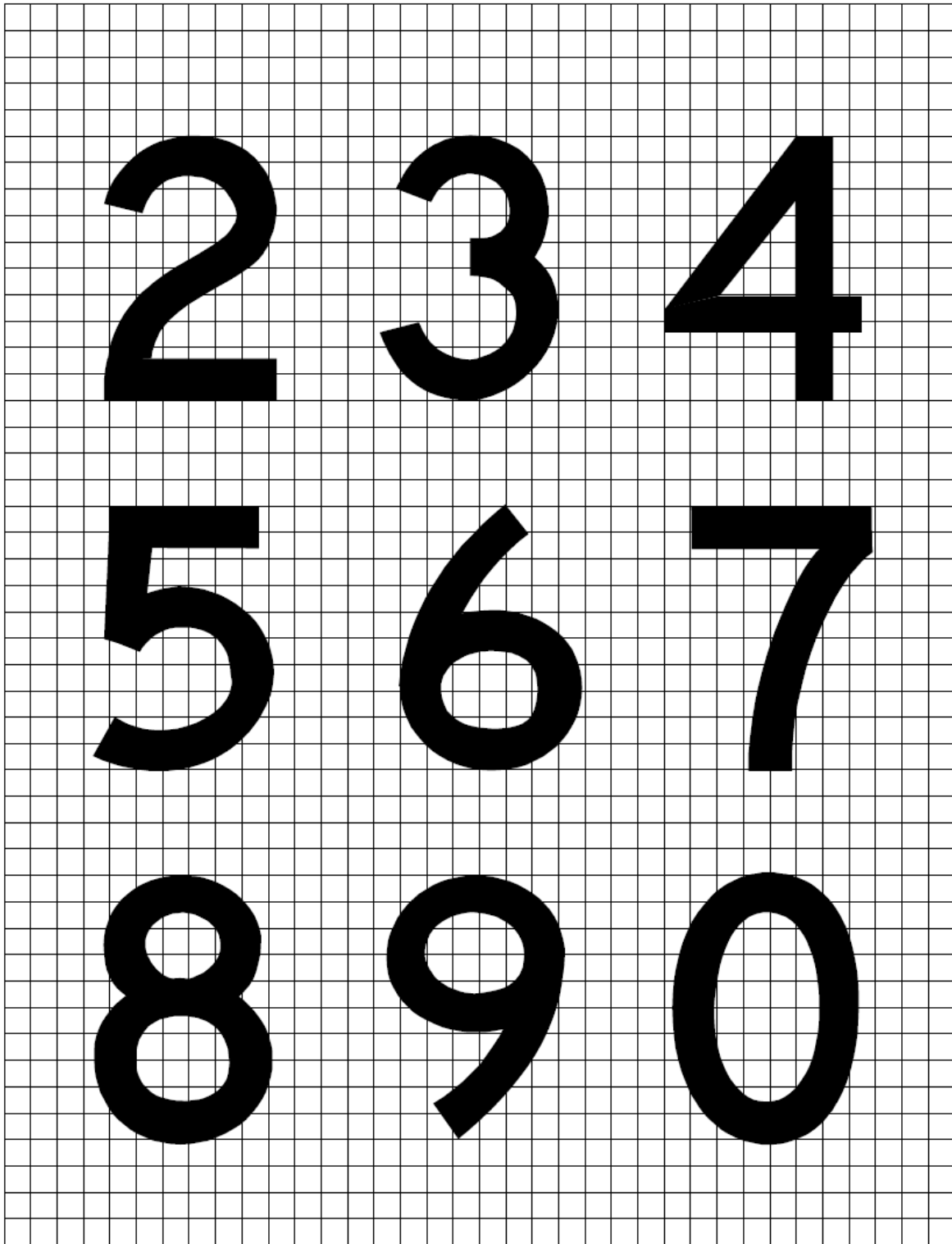

Figure A4-2. Forms of characters (cont.)

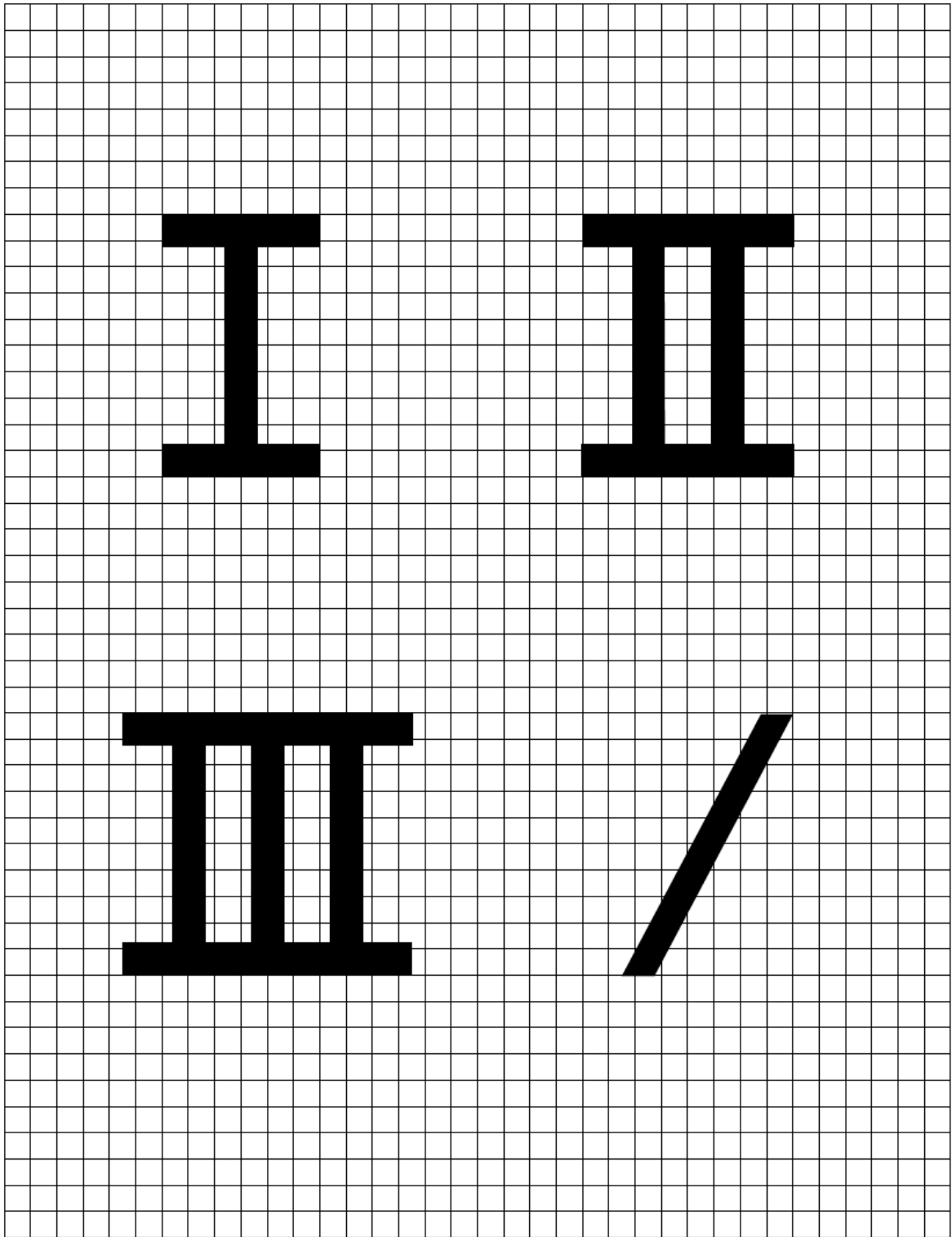
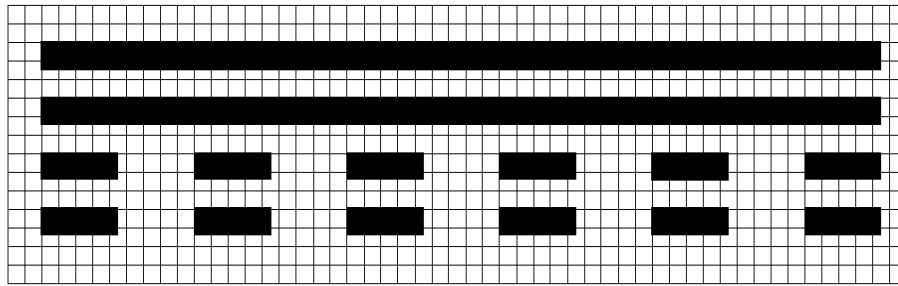
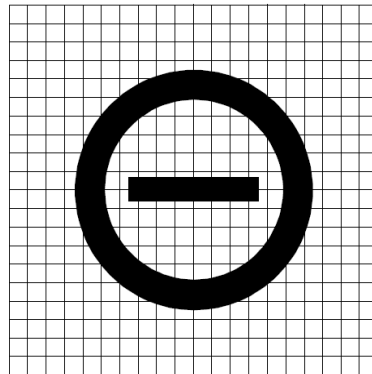

Figure A4-2. Forms of characters (cont.)



Runway vacated sign



NO ENTRY sign

Note.— Existing NO ENTRY signs not conforming to these dimensions are to be replaced not later than 1 January 2012.

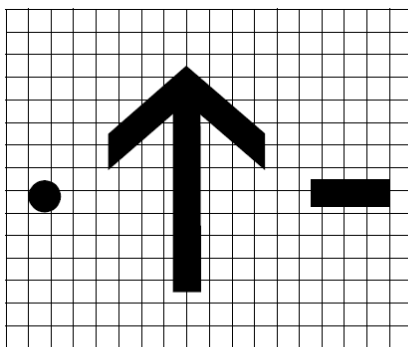

Arrow, dot and dash

Note 1.— The arrow stroke width, diameter of the dot, and both width and length of the dash shall be proportioned to the character stroke widths.

Note 2.— The dimensions of the arrow shall remain constant for a particular sign size, regardless of orientation.

Figure A4-2. Forms of characters (cont.)

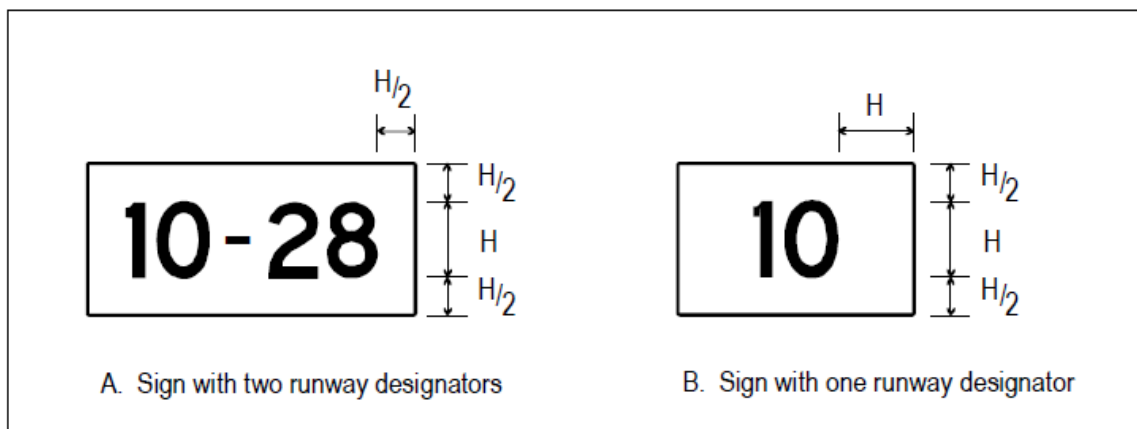

Figure A4-3. Sign dimensions

a) Letter to letter code number			
Preceding Letter	Following Letter		
	B, D, E, F, H, I, K, L, M, N, P, R, U	C, G, O, Q, S, X, Z	A, J, T, V, W, Y
	Code number		
A	2	2	4
B	1	2	2
C	2	2	3
D	1	2	2
E	2	2	3
F	2	2	3
G	1	2	2
H	1	1	2
I	1	1	2
J	1	1	2
K	2	2	3
L	2	2	4
M	1	1	2
N	1	1	2
O	1	2	2
P	1	2	2
Q	1	2	2
R	1	2	2
S	1	2	2
T	2	2	4
U	1	1	2
V	2	2	4
W	2	2	4
X	2	2	3
Y	2	2	4
Z	2	2	3

b) Numeral to numeral code number			
Preceding Numeral	Following number		
	1, 5	2, 3, 6, 8, 9, 0	4, 7
	Code number		
1	1	1	2
2	1	2	2
3	1	2	2
4	2	2	4
5	1	2	2
6	1	2	2
7	2	2	4
8	1	2	2
9	1	2	2
0	1	2	2

c) Space between characters			
Code No.	Letter height (mm)		
	200	300	400
	Space (mm)		
1	48	71	96
2	38	57	76
3	25	38	50
4	13	19	26

d) Width of letter			
Letter	Letter height (mm)		
	200	300	400
	Width (mm)		
A	170	255	340
B	137	205	274
C	137	205	274
D	137	205	274
E	124	186	248
F	124	186	248
G	137	205	274
H	137	205	274
I	32	48	64
J	127	190	254
K	140	210	280
L	124	186	248
M	157	236	314
N	137	205	274
O	143	214	286
P	137	205	274
Q	143	214	286
R	137	205	274
S	137	205	274
T	124	186	248
U	137	205	274
V	152	229	304
W	178	267	356
X	137	205	274
Y	171	257	342
Z	137	205	274

e) Width of numeral			
Numeral	Numeral height (mm)		
	200	300	400
	Width (mm)		
1	50	74	98
2	137	205	274
3	137	205	274
4	149	224	298
5	137	205	274
6	137	205	274
7	137	205	274
8	137	205	274
9	137	205	274
0	143	214	286

INSTRUCTIONS

1. To determine the proper SPACE between letters or numerals, obtain the code number from table a) or b) and enter table c) for that code number to the desired letter or numeral height.
2. The space between words or groups of characters forming an abbreviation or symbol should be equal to 0.5 to 0.75 of the height of the characters used except that where an arrow is located with a single character such as 'A →', the space may be reduced to not less than one quarter of the height of the character in order to provide a good visual balance.
3. Where the numeral follows a letter or vice versa use Code 1.
4. Where a hyphen, dot, or diagonal stroke follows a character or vice versa use Code 1.

Table A4-1. Letter and numeral widths and space between letters and numerals

Appendix 5 Aeroplane characteristics

A list of representative aeroplanes operating in New Zealand, chosen to provide an example of each possible aerodrome reference code number and letter combination, is shown below.

For a particular aeroplane the table also provides data on the aeroplane reference field length (ARFL), wingspan and outer main gear wheel span used in determining the aerodrome reference code. The aeroplane data provided for planning purposes is indicative only. Exact values of a particular aeroplane's performance characteristics should be obtained from information published by the aeroplane manufacturer.

AEROPLANE TYPE	REF CODE	AEROPLANE CHARACTERISTICS					
		ARFL (m)	Wing-span (m)	Outer Main Gear Wheel Span (m)	Length (m)	MCTOW (kg)	Tyre Pressure (kPa)
DHC2 Beaver	1A	381	14.6	3.3	10.3	2490	240
Beechcraft: 58 (Baron)	1A	401	11.5	3.1	9.1	2449	392
100	1A	628	14.0	4.0	12.2	5352	-
Britten Norman Islander	1A	353	14.9	4.0	10.9	2850	228
Cessna: 172	1A	272	10.9	2.7	8.2	1066	-
206	1A	274	10.9	2.6	8.6	1639	-
310	1A	518	11.3	3.7	9.7	2359	414
404	1A	721	14.1	4.3	12.1	3810	490
Partenavia P68	1A	230	12.0	2.6	9.4	1960	-
Piper: PA 31 (Navajo)	1A	639	12.4	4.3	9.9	2950	414
PA 34	1A	378	11.8	3.4	8.7	1814	-
Beechcraft 200	1B	592	16.6	5.6	13.3	5670	735
Cessna: 208A (Caravan)	1B	296	15.9	3.7	11.5	3310	-
402C	1B	669	13.45	5.6	11.1	3107	490
441	1B	544	15.1	4.6	11.9	4468	665
DHC 6 Twin Otter	1B	695	19.8	4.1	15.8	5670	220
Dornier 228-200	1B	525	17.0	3.6	16.6	5700	-
DHC-7	1C	689	28.4	7.8	24.6	19505	620

AEROPLANE TYPE	REF CODE	AEROPLANE CHARACTERISTICS					
		ARFL (m)	Wing-span (m)	Outer Main Gear Wheel Span (m)	Length (m)	MCTOW (kg)	Tyre Pressure (kPa)
DHC-5E	1D	290	29.3	10.2	24.1	22316	-
Lear Jet 28/29	2A	912	13.4	2.5	14.5	6804	793
Beechcraft 1900	2B	811	16.6	5.8	17.6	7530	-
CASA C-212	2B	866	20.3	3.5	16.2	7700	392
Embraer EMB110	2B	1199	15.3	4.9	15.1	5670	586
ATR 42-200	2C	1010	24.6	4.9	22.7	16150	728
Cessna 550	2C	912	15.8	6.0	14.4	6033	700
DHC-8: 100	2C	948	25.9	8.5	22.3	15650	805
300	2C	1122	27.4	8.5	25.7	18642	805
Lear Jet 55	3A	1292	13.4	2.5	16.8	9298	-
Metro II	3A	1341	14.1	5.4	18.1	5670	740
IAI Westwind 2	3A	1495	13.7	3.7	15.9	10660	1000
BAe 125-400	3B	1713	15.7	3.3	15.5	12480	1007
Canadair: CL600	3B	1737	18.9	4.0	20.9	18642	1140
CRJ-200	3B	1527	21.21	4.0	26.77	21523	1117
Cessna 650	3B	1581	16.3	3.6	16.9	9979	1036
Dassault-Breguet: Falcon 900	3B	1515	19.3	5.3	20.2	20640	1300
Embraer EMB 145	3B	1500	20	4.8	29.9	19200	-
Fokker F28-2000	3B	1646	23.6	5.8	29.6	29480	689
Metro 23/III	3B	1341	17.4	5.4	18.1	7484	742
Shorts SD3-60	3B	1320	22.8	4.6	21.6	11793	758

AEROPLANE TYPE	REF CODE	AEROPLANE CHARACTERISTICS					
		ARFL (m)	Wing-span (m)	Outer Main Gear Wheel Span (m)	Length (m)	MCTOW (kg)	Tyre Pressure (kPa)
ATR 72-500	3C	1223	27.0	4.3	27.2	22000	-
BAe: Jetstream 31	3C	1440	15.9	6.2	14.4	6950	448
Jetstream 41	3C	1500	18.3	-	19.3	10433	-
146-200	3C	1615	26.3	5.5	26.2	42185	1138
146-300	3C	1615	26.3	5.5	31.0	44225	945
Bombardier Global Express	3C	1774	28.7	4.9	30.3	42410	-
Embraer EMB 120	3C	1420	19.8	7.3	20.0	11500	828
McDonnell Douglas: DC-3	3C	1204	28.8	5.8	19.6	14100	358
DC9-20	3C	1551	28.5	6.0	31.8	45360	972
Fokker: F27-500	3C	1670	29.0	7.9	25.1	20412	540
F28-4000	3C	1640	25.1	5.8	29.6	32205	779
F50	3C	1760	29.0	8.0	25.2	20820	552
F100	3C	1695	28.1	5.0	35.5	44450	920
SAAB SF-340	3C	1220	21.4	7.5	19.7	12371	655
Airbus A300 B2	3D	1676	44.8	10.9	53.6	142000	1241
Airbus A320-200	4C	2058	33.9	8.7	37.6	72000	1360
Boeing: B717-200	4C	2130	28.4	6.0	37.8	51710	-
B737-200	4C	2295	28.4	6.4	30.6	52390	1145
B737-300	4C	2749	28.9	6.4	30.5	61230	1344
B737-400	4C	2499	28.9	6.4	36.5	63083	1400
B737-800	4C	2256	34.3	6.4	39.5	70535	-
McDonnell Douglas: DC9-30	4C	2134	28.5	6.0	37.8	48988	-
DC9-80/MD80	4C	2553	32.9	6.2	45.1	72575	1390

AEROPLANE CHARACTERISTICS							
AEROPLANE TYPE	REF CODE	ARFL (m)	Wing-span (m)	Outer Main Gear Wheel Span (m)	Length (m)	MCTOW (kg)	Tyre Pressure (kPa)
Airbus: A300-600	4D	2332	44.8	10.9	54.1	165000	1260
A310-200	4D	1845	43.9	10.9	46.7	132000	1080
Boeing: B757-200	4D	2057	38.0	8.7	47.3	108860	1172
B767-200ER	4D	2499	47.6	10.8	48.5	156500	1310
B767-300ER	4D	2743	47.6	10.8	54.9	172365	1310
McDonnell Douglas: DC8-63	4D	3179	45.2	7.6	57.1	158757	1365
DC10-30	4D	3170	50.4	12.6	55.4	251744	1276
Lockheed: L1011-100/200	4D	2469	47.3	12.8	54.2	211378	1207
McDonnell Douglas MD11	4D	2207	51.7	12.0	61.2	273289	1400
Tupolev TU154	4D	2160	37.6	12.4	48.0	90300	-
Airbus: A330-200	4E	2713	60.3	12.0	59.0	230000	1400
A330-300	4E	2560	60.3	12.0	63.6	230000	1400
A340-300	4E	2200	60.3	12.0	63.7	253500	1400
Boeing: B747-SP	4E	2710	59.6	12.4	56.3	318420	1413
B747-300	4E	3292	59.6	12.4	70.4	377800	1323
B747-400	4E	3383	64.9	12.4	70.4	394625	1410
B777-200	4E	2500	60.9	12.8	63.73	287800	1400
Airbus A380-800	4F	3350	79.8	14.3	72.7	560000	1400